



Catalogue
2024



Navegación interactiva.

Interactive navigation.



- Pincha en cada novedad para más información | Click on each new product for more information.



- Navega desde los índices a las categorías y colecciones | From indexes to categories and collections.



BOTONES PARA RETROCEDER | BACK BUTTONS

- Utiliza los iconos "New" para volver a la página de novedades | Use "new" icons to return to new products' index.



- Utiliza los pies de página para volver a las categorías | Use footers to return to categories.





Ibili, since 1942

NUESTRA HISTORIA

Llevamos fabricando y distribuyendo menaje de cocina desde 1942. En todos estos años hemos aprendido que los nuevos tiempos requieren de nuevas ideas, y que la cultura de la **innovación** es la que favorece la adaptación a mercados y necesidades incipientes. La innovación nos ha acompañado en todo este viaje y el resultado es que IBILI actualmente es una marca de confianza, comprometida con la **calidad** de sus productos y con el **servicio** que ofrece a sus clientes.

Actualmente producimos y comercializamos todo tipo de productos relacionados con el menaje de cocina para el hogar y la hostelería. Seguimos innovando, a través del **diseño** propio y la fabricación en una amplia variedad de materiales. Queremos ser sostenibles porque nos preocupa el medio ambiente. Pero sobre todo queremos ser honestos porque nos preocupan las personas. **Honestidad, Salud y Sostenibilidad**, son tres de nuestros principales valores.

Hemos creado nuestro universo IBILI online. Nos encontrarás en las redes sociales y en muchas tiendas pequeñas y grandes, porque todo este trabajo ha derivado en un catálogo de más de 3.500 referencias de producto y un almacén logístico de 32.000m² ubicado en Alegria-Dulantzi (Alava), construido por el Grupo Marcos Larrañaga, al que pertenecemos.

OUR HISTORY

We've been manufacturing and distributing kitchenware since 1942. In all those years, we've learned that new times require new ideas. And that the culture of **innovation** is what fosters adaptation to emerging markets and needs. Innovation has been by our side during the entire voyage. And the result is that today IBILI is a trustworthy brand, committed to the **quality** of its products and the **services** it provides to clients.

Today, we produce and commercialise all kinds of products related with kitchenware for the home and hospitality industry. We keep innovating, using our **own designs** and manufacturing with a wider variety of materials. We want to be sustainable because we're concerned about the environment. But above all, we want to be honest, because we're concerned about people. **Honesty, Health and Sustainability** are three of our core values.

We've created our online IBILI universe. You can find us on the social networks and in a lot of small and large shops, because all the work we've done has led to more than 3,500 items and a logistics warehouse of 32,000 m² in Alegria-Dulantzi, Alava that was built by the Marcos Larrañaga Group, which we belong to.

NOTRE HISTOIRE

Nous fabriquons et distribuons des articles de cuisine depuis 1942. Au cours de toutes ces années, nous avons appris que les temps nouveaux exigent des idées nouvelles et que la culture de l'**innovation** favorise l'adaptation aux marchés et aux besoins émergents. L'innovation nous a accompagnés tout au long de ce parcours et le résultat est qu'IBILI est aujourd'hui une marque de confiance, engagée dans la **qualité** de ses produits et le **service** qu'elle offre à ses clients.

Aujourd'hui, nous produisons et commercialisons toutes sortes de produits liés aux articles de cuisine pour la maison et l'hôtellerie. Nous continuons à innover, en introduisant notre propre **design** et en fabriquant une plus grande variété de matériaux. Nous voulons être durables parce que nous nous soucions de l'environnement. Mais avant tout, nous voulons être honnêtes parce que nous nous soucions des personnes. L'**honnêteté, la santé et la durabilité** sont trois de nos principales valeurs.

Nous avons créé notre univers en ligne IBILI. Vous nous trouverez sur les réseaux sociaux et dans de nombreux petits et grands magasins, car tout ce travail a abouti à plus de 3 500 références de produits et à un entrepôt logistique de 32 000 m² situé à Alegria-Dulantzi (Alava), construit par le groupe Marcos Larrañaga, auquel nous appartenons.

A NOSSA HISTÓRIA

Somos fabricantes e distribuidores de materiais de cozinha desde 1942. Ao longo de todos estes anos, aprendemos que os novos tempos requerem novas ideias, e que a cultura da **inovação** favorece a adaptação aos mercados e às novas necessidades. A inovação tem-nos acompanhado sempre nesta viagem, e o resultado é que IBILI é, hoje em dia, uma marca de confiança, comprometida com a **qualidade** dos seus produtos e com o **serviço** que oferece aos seus clientes.

Atualmente produzimos e comercializamos todo o tipo de produtos relacionados com os utensílios de cozinha para uso doméstico e para a hotelaria. Continuamos a inovar, introduzindo o nosso **design** próprio e fabricando artigos numa variedade crescente de materiais. Queremos ser sustentáveis, porque nos preocupamos pelo meio ambiente. Mas queremos sobretudo ser honestos, porque nos preocupamos pelas pessoas. **Honestidade, Saúde e Sustentabilidade** são três dos nossos principais valores.

Criámos o nosso universo IBILI online. Estamos presentes nas redes sociais e em muitas lojas, pequenas e grandes, porque todo este trabalho se traduz em mais de 3500 referências de artigos, que distribuímos a partir de um armazém logístico de 32000m² localizado em Alegria -Dulantzi (Álava), construído pelo Grupo Marcos Larrañaga, ao qual pertencemos.



SINCE
1942.

80%

de plásticos desechables
eliminados de nuestros
embalajes

of single-use plastics have been **eliminated** from our packaging
des plastiques jetables sont **éliminés** de nos emballages
dos plásticos descartáveis **eliminados** das nossas embalagens



Libres de BPA
BPA free
Sans BPA*
Sem BPA



Libres de PFOA
PFOA free
Sans PFOA
Sem PFOA



Nuevos recubrimientos libres de PFAS
New PFAS Free ceramic coatings
Nouveaux revêtements sans PFAS
Novos revestimentos sem PFAS



ES La empresa se reserva el derecho a cualquier modificación en fotografías, datos técnicos o precios.
La empresa no acepta devoluciones de piezas en buen estado sin previo acuerdo entre las partes.
Los abonos de las piezas en buen estado se realizarán al 90% del precio al que se vendieron originalmente.
Los costes de transporte de las piezas en buen estado deben ser a cargo del cliente.

EN The company reserves the right to change any photographs, technical data or prices.
The company does not accept returns of items in good condition without prior agreement between the parties.
Credit for items in good condition will be granted at 90% of the original sales price.
Transport costs for items in good condition will be paid by the customer.

FR L'entreprise se réserve le droit de modifier les photographies, les données techniques et les prix.
L'entreprise n'accepte pas les retours de pièces en bon état sans accord préalable entre les parties.
Les pièces en bon état seront créditées à 90 % du prix auquel elles ont été vendues.
Les frais de transport des pièces en bon état sont à la charge du client.
*Les articles indiqués comme "Polycarbonate" sont interdit à la vente en France.

PT A empresa reserva-se o direito de efetuar qualquer modificação nas fotografias, características técnicas ou preços.
A empresa não aceita a devolução de artigos em bom estado sem prévio acordo entre as partes
O reembolso dos artigos em bom estado estará limitado a 90% do seu preço de venda original.
Os custos de transporte dos artigos em bom estado ficarão a cargo do cliente.



induction

Apto para Inducción

Suitable for Induction
Convient à L'Induction
Geeignet Für Induktion
Adequado para Indução



vitro

Apto para Vitrocerámica

Suitable for Vitroceramic Cooker
Convient à la cuisinière vitrocéramique
Geeignet für Vitrokeramik-Kochfeld
Adequado para fogão vitrocerâmico



electric

Apto para Cocina Eléctrica

Suitable for Electric Cooker
Convient aux cuisinières électriques
Geeignet für Elektroherd
Adequado para fogão elétrico



gas

Apto para Gas

Suitable for Gas Cooker
Convient aux cuisinières à gaz
Geeignet für Gasherd
Adequado para fogão a gás



non-stick

Con Recubrimiento Antiadherente

Non-stick coating
Revêtement antiadhésif
Mit Antihafbeschichtung
Com revestimento antiaderente



Apto para la lavadora

Machine washable
Lavable en machine
Maschinenwaschbar
Lavável à máquina



Apto para horno

Oven safe
Peut être mis au four
Backofenfest
Cofre de forno



No apto para horno

Not suitable for oven
Ne convient pas pour le four
Nicht für den Backofen geeignet
Não adequado para forno



Apto para Lavavajillas

Dishwasher safe
Lavable au lave-vaisselle
Spülmaschinenfest
Pode ser lavado na máquina de lavar louça



No apto para Lavavajillas

Not dishwasher safe
Ne passe pas au lave-vaisselle
Nicht spülmaschinenfest
Não pode ser lavado na máquina de lavar louça



Apto para frigorífico

Suitable for refrigerator
Convient pour le réfrigérateur
Geeignet für Kühlschrank
Adequado para frigorífico



No Apto para frigorífico

Not suitable for refrigerators
Ne convient pas aux réfrigérateurs
Nicht für Kühlschränke geeignet
Não adequado para frigoríficos



Apto para Microondas

Microwave safe
Au four à micro-ondes
Mikrowellengeeignet
Pode ir ao micro-ondas



No apto para Microondas

Not suitable for microwaves
Ne convient pas aux micro-ondes
Nicht für Mikrowellen geeignet
Não adequado para micro-ondas



Fondo Capsulado

Capped bottom
Fondo diffuseur
Kapselboden
Fondo difusor



Apto para cuchillo

Suitable for knife
Convient pour les couteaux
Geeignet für Messer
Adequado para facas



No apto para cuchillo

Not suitable for knives
Ne convient pas aux couteaux
Nicht für Messer geeignet
Não adequado para facas



Apto para congelador

Freezer safe
Au congélateur
Geeignet zum Einfrieren
Adequado para congelação



No apto para congelador

Not suitable for freezer
Ne convient pas au congélateur
Nicht zum Einfrieren geeignet
Não adequado para congelação



Incluye Receta

Includes recipe
Recette incluse
Inklusive Rezept
Inclui receita



No acercar al fuego

Do not approach the fire
Ne pas s'approcher du feu
Nähern Sie sich dem Feuer nicht
Não se aproximar do fogo



Producido a Mano

Hand made
Fait à la main
Handgefertigt
Produzido à mão



Vacio Interior Doble Pared

Double Wall Vacuum
Double paroi Le vide intérieur
Doppelwandiges Innenvakuum
Vácuo interior com parede dupla



reciclable

Recicable

Recyclable
Recyclable
Wiederverwertbar
Reciclável



compost

Compost

Compost
Compost
Kompost
Composto



PEFC

Cumple la normativa PEFC

Complies with PEFC regulations
Conforme à la norme PEFC
PEFC-konform
Conformidade com PEFC



LFGB

Cumple la normativa LFGB

Complies with LFGB regulations
Conforme aux normes LFGB
LFGB-konform
Conformidade com LFGB



1xAAA included

Incluye Pilas

Batteries included
Piles incluses
Inklusive Batterien
Pilhas incluídas



1AAA NOT included

No incluye Pilas

Batteries not included
Piles non incluses
Batterien nicht enthalten
Pilhas não incluídas



30 min

Tiempo de uso

Time of use
Durée d'utilisation
Zeit der Nutzung
Tempo de utilização



+12h

Tiempo que mantiene la temperatura

Time maintaining temperature
Température maximale et minimale
Maximale und minimale Temperatur
Temperatura máxima e mínima



100°C/-40°C

Temperatura Máxima y Mínima

Maximum and minimum temperatures
Temps de maintien de la température
Zeit zum Halten der Temperatur
Tempo para manter a temperatura



Diseñado por Ibili

Designed by Ibili
Conçu par Ibili
Entworfen von Ibili
Concebido por Ibili



Porciones

portions
portions
Portionen
porções



Raciones

Rations
Rations
Rationen
Rações



Apto para freidora de aire

Suitable for air fryer
Convient à la friteuse
Geeignet für Heißluftfritteuse
Adequado para fritadeira de ar quente



Tazas

Cups
Tasses
Becher
Canecas



3 mm

Espesor

Thickness
Épaisseur
Dichte
Espessura



Unidad de Embalaje

Packaging Unit
Unité d'emballage
Verpackungseinheit
Unidade de embalagem

L

Largo

Length
Longueur
Länge
Comprimento

W

Ancho

Width
Largeur
Breite
Largura

H

Alto

Height
Hauter
Hoch
Altura

lts

Litros

Litres
Litres
Lître
Litros



Diametro

Diameter
Diamètre
Durchmesser
Diâmetro



Diametro Interior

Inner Diameter
Diamètre intérieur
Innendurchmesser
Diâmetro interior



Fondo

Bottom
Fondo
Boden
Canecas



Fuego Recomendado

Recommended Hob
Feu recommandé
Empfohlenes Feuer
Fogo recomendado



Paso de Rejilla

Grid pitch
Pas de grille
Rasterweite
Passo da grelha



hanger

Con Colgador

With hanger
Avec crochet
Mit Aufhänger
Com gancho



NOVEDADES NEWS 2024.



VOLVER BACK

INICIO HOME

ICONOS ICONS

Kompakt. **Olla a Presión**
Pressure Cooker

NEW 2,5L



Pág.016

Ebbe. **Olla**
Pot



Pág.021

Ebbe. **Cacerola**
Casserole



Pág.022

Ebbe. **Cazo**
Saucepan



Pág.022

Quarzo. **Wok**
Wok



Pág.040

Quarzo. **Sartén Honda**
Deep Frying Pan



Pág.040

Quarzo. **Grill**
Grill



Pág.041

Quarzo. **Crepiera**
Pancake Pan



Pág.041

Triply Natural. **Sartén**
Frying Pan

NEW 18-22-26CM



Pág.046

Triply Natural. **Sautex**
Stewing Pan



Pág.046

Triply Natural. **Wok**
Wok



Pág.046

Triply Natural. **Grill**
Square Grill



Pág.046

Natura. **Grill Liso**
Plain Grill



Pág.048

Nova Ceram. **Sartén**
Frying Pan



Pág.056

Plato de Hierro Fundido Rectangular + Base de Madera
Rectangular Cast Iron Plate + Wooden Base



Pág.068

Molde Empanadillas Inox
Stainless Steel Dumpling Maker

NEW 15CM



Pág.126

Soporte Giratorio Prof
Prof Rotating Stand



Pág.163

Jarra Medidas con Asa
Straight Measuring Jug with Handle



Pág.174

Moca. Cafetera Express Rosso
Rosso Espresso Maker



Pág.194

Moca. Cafetera Express Blu
Blu Espresso Maker



Pág.194

Moca. Cafetera Express Cupra
Cupra Espresso Maker



Pág.194

Moca. Cafetera Express Mini 2 Tazas
Mini 2-cup Espresso Maker



Pág.194

Elba. Cafetera Express Green
Green Espresso Maker



Pág.196

Elba. Cafetera Express Coffee
Coffee Espresso Maker



Pág.196

Bahía. Cafetera Express
Espresso Coffee Maker

NEW 1 TAZA



Pág.198

Tetera Negra
Negra Teapot

NEW 1L



Pág.203

Tetera Lamam
Lamam Teapot



Pág.207

Tetera Yame
Yame Teapot



Pág.207

Set Matcha 3 piezas
Matcha Set 3 pieces



Pág.229

Cepillo para Botellas y Termos de Silicona
Bottle and Thermos Brush



Pág.230

Vaso Doble Pared Luxe
Luxe Double-Walled Thermal Mug



Pág.220

Vaso Doble Pared Sport
Sport Double-Walled Thermal Mug



Pág.220

Castilla Blanco. **Set 18 Piezas Blanco**
Set of 18 White Pieces



Pág.235

Bolonia Blanco. **Set 18 Piezas Blanco**
Set of 18 White Pieces



Pág.236

Castilla Blanco. **Plato Hondo Blanco**
White Deep Plate



Pág.235

Castilla Blanco. **Plato Postre Blanco**
White Dessert Plate



Pág.235

Bolonia Blanco. **Plato Hondo Blanco**
White Deep Plate



Pág.236

Bolonia Blanco. **Plato Postre Blanco**
White Dessert Plate



Pág.236

Castilla Blanco. **Plato Llano Blanco**
White Flat Plate



Pág.235

Bolonia Blanco. **Plato Llano Blanco**
White Flat Plate



Pág.236

Armonía Blu. **Set 12 Piezas Azul**
Set 12 Blue Pieces

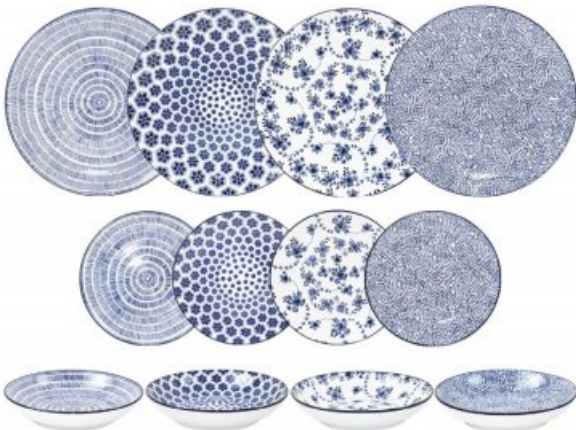

Pág.237

Armonía Black. **Set 12 Piezas Negro**
Set 12 Black Pieces

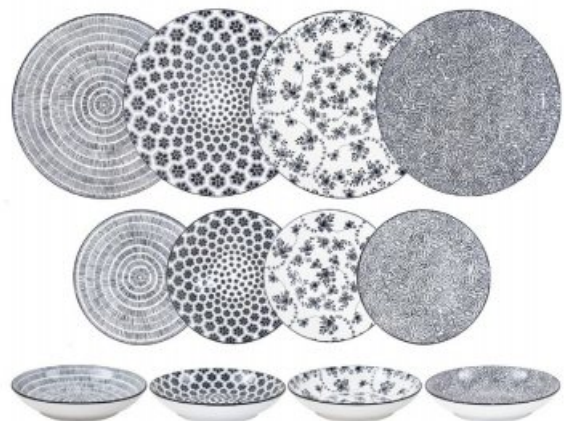

Pág.238

Bol Azul Surtido M

Blue Bowl Assorted M



Pág.239

Bol Verde Surtido M

Green Bowl Assorted M



Pág.239

Bol Negro Surtido M

Black Bowl Assorted M



Pág.239

Bol Azul Surtido L

Blue Bowl Assorted L



Pág.239

Bol Verde Surtido L

Green Bowl Assorted L



Pág.239

Bol Negro Surtido L

Black Bowl Assorted L



Pág.239

Mug Surtido Azul

Blue Mug Assorted



Pág.239

Mug Surtido Verde

Green Mug Assorted



Pág.239

Mug Surtido Negro

Black Mug Assorted



Pág.239

Vaporera de Bambú

Bamboo Steamer

NEW 26CM



Pág.245

Papel para Vaporera

Steamer Paper



Pág.245

Panera con Forro de Tela

Bread Bin with Fabric Lining



Pág.251

Vaporizador de Aceite Eco

Eco Oil Spray



Pág.260

Táper para Embutidos y Fiambres

Container for Deli Meats and Cold Cuts

NEW GREEN COLOR



Pág.277

Cuchillo Dentado Colorful
Colorful Serrated Knife



Pág.286

Mandolina Vertical
Vertical Mandoline



Pág.300

Mandolina Regulable Class
Class Adjustable Mandoline



Pág.300

Set 3 Ralladores Basic
Basic Set of 3 Graters



Pág.313

Tapa Multiuso Cuadrada
Square Multiuse Lid



Pág.316

Tabla para Corte con Tope
Cutting Board with Stopper



Pág.318

Intense. Rallador Curvo
Curved Grater



Pág.326

Malmo. Cuchara
Spoon



Pág.327

Malmo. Cuchara Pasta
Pasta Spoon



Pág.327

Malmo. Espumadera
Skimmer



Pág.327

Malmo. Cacillo
Ladle



Pág.327

Malmo. Espátula
Spatula



Pág.327

Plato de Madera
Wooden Plate



Pág.338

Molde Hamburguesa Inox
Stainless Steel Burger Mold



Pág.343

Papel Separador de Hamburguesas
Hamburger Patty Paper



Pág.343

Mortero de Bambú
Bamboo Mortar

NEW 14CM



Pág.346

Jarra de Agua
Water Jug

NEW 600ml



Pág.348

Organizador de Latas Nevera
Can Organizer



Pág.359

Recogemigas Confort
Confort Crumb Sweeper



Pág.362

Barware. Set 2 Tapones de Sidra
Set 2 Cider Stoppers



Pág.376

Barware.

Set 2 Descapsuladores Curvos

Set of 2 Curved Bottle Opener



Pág.385

Manopla Silicona

Silicone Oven Glove



Pág.390

Set 2 Manoplas de Silicona

Set of 2 Silicone Oven Mitts



Pág.390

Taza Doble Pared Inox

Double-Walled Stainless Steel Cup



Pág.414

Bolsa Isotérmica Porta Botellas

Dalvik Isothermal Bottle Bag



Pág.413

VOLVER BACK

INICIO HOME

NOVEDADES NEW

ICONOS ICONS



Baterías

Pág.013

Cookware · Bateria de Cuisine
Kochtopf-Set · Bateria de Cozinha



Sartenes y Grills

Pág.037

Frypans-Grills · Poêles-Grills
Pfannen-Grills · Frigideiras-Grelhadores



Paelleras

Pág.069

Paella Pans · Plats à Paëlla
Paellapfannen · Paelheiras



Repostería

Pág.075

Bakeware · Patisserie
Konditoreiwaren · Pastelaria



Café y Té

Pág.191

Coffee & Tea · Cafétéria
Kaffee & Tee · Cafetaria

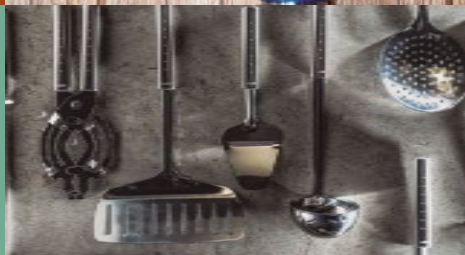

Varios Cocina-Mesa

Pág.233

Kitchen Table · Divers Cuisine-Table
Verschiedenes Küche/Tisch · Varios Cozinha-Mesa

Baterías.



Cookware

Batteries de Cuisine

Kochtopf-Set

Baterias de Cozinha

<u>Exklusiv</u>	015
<u>Kompakt</u>	016
<u>Neo</u>	017
<u>Excellent Titanio</u>	018
<u>Evolution</u>	019
<u>Svea</u>	020
<u>Ebbe</u>	021
<u>Noah</u>	023
<u>Oslo</u>	025
<u>Prisma</u>	026
<u>Clásica</u>	026
<u>Óptima</u>	026
<u>Induktion</u>	027
<u>Natura</u>	028
<u>Natura Copper</u>	029
<u>Cocotte</u>	030
<u>Inducta</u>	031
<u>Indubasic</u>	032
<u>Venus</u>	032
<u>Acero Esmaltado</u>	033
<u>Cacerola Horno</u>	034
<u>Varios</u>	035

Exklusiv.

ACERO INOXIDABLE 18/10

STAINLESS STEEL 18/10

ACIER INOXYDABLE 18/10

ROSTFREIER STAHL 18/10

AÇO INOXIDÁVEL 18/10



induction



vitro



electric



gas



Fondo capsulado
Capsulated bottom
Fondo diffuseur
Kapselboden
Fondo difusor

Olla a Presión

Pressure Cooker

Cocotte à Pression

Schnellkochtopf

Panela a Pressão



- **Mango y asa de baquelita**
- **Marcaje interior de capacidad**
- **Dos niveles de uso. Nivel 1 rápido, para texturas más suaves como verduras y pescado. Nivel 2 superrápido, para carnes y legumbres**
- **Triple sistema de seguridad**
- **Su cuerpo recto permite una mayor superficie de contacto de la base con la fuente de energía**
- **Junta de silicona**
- **Todos los repuestos necesarios se encuentran disponibles (para más info. consultar www.ibilimenaje.com)**
- Baquelite handles
- Inner marking with capacity
- Two levels of use. Level 1 fast, for softer textures such as vegetables and fish. Level 2 super-fast, for meats and legumes
- Triple security system
- Silicone gasket
- All necessary spare parts are available (for more info. consult www.ibilimenaje.com)

ref.	∅ (cm)	H (cm)	Lts	☞ (cm)	Ⓜ (cm)	📦	Bar Code
628904	22	11,50	4	21,50	±2	1/2	8411922472127
628906	22	16,50	6	21,50	±2	1/2	8411922472134
628910	22	11,50+16,50	4+6	21,50	±2	1/2	8411922472141

Kompakt.

ACERO INOXIDABLE 18/10

STAINLESS STEEL 18/10
ACIER INOXYDABLE 18/10
ROSTFREIER STAHL 18/10
AÇO INOXIDÁVEL 18/10



induction



vitro



electric



gas



Fondo capsulado
Capsulated bottom
Fondo diffusor
Kapselboden
Fondo difusor



Olla a Presión

Pressure Cooker
Cocotte à Pression
Schnellkochtopf
Panela a Pressão



- **Mango y asa de baquelita**
- **Marcaje interior de capacidad**
- **Dos niveles de uso. Nivel 1 rápido, para texturas más suaves como verduras y pescado. Nivel 2 superrápido, para carnes y legumbres**
- **Triple sistema de seguridad**
- **Junta de silicona**
- **Todos los repuestos necesarios se encuentran disponibles (para más info. consultar www.ibilimenaje.com)**
- Baquelite handles
- Inner marking with capacity
- Two levels of use. Level 1 fast, for softer textures such as vegetables and fish. Level 2 super-fast, for meats and legumes
- Triple security system
- Silicone gasket
- All necessary spare parts are available (for more info. consult www.ibilimenaje.com)

ref.	Ø (cm)	H (cm)	Lts	☞ (cm)	Ⓜ (cm)	📦	Bar Code
629002	16	11	2	14	±2	1/4	8411922473155
629003	16	13	2,50	14	±2	1/4	8411922475388

NEW

Neo.

ALUMINIO FUNDIDO

CAST ALUMINUM
FONTE D'ALUMINIUM
ALUMINIUMGUSS
ALUMÍNIO FUNDIDO



QuanTanium[®]
Titanium-reinforced non-stick coating



- Asas Desmontables Silicona
- Full Induction
- Tapa de Cristal con Borde de Silicona
- Detachable Handles Silicone
- Full Induction
- Glass Lid With Silicone Ring

Guisera

Stewing Pan
Sauteuse
Schmorpfanne
Caçarola Baixa

ref.	∅ (cm)	H (cm)	Lts	☰ (cm)	⊙ (cm)	📦	Bar Code
464024	24	6,30	2,30	21	±2	1/4	8411922458084
464028	28	7,20	3,70	25,30	±2	1/4	8411922458091
464032	32	8,50	5,70	28,80	±2	1/4	8411922458107
464036	36	8,80	7,40	31,80	±2	1/2	8411922458114



Cacerola

Casserole
Faitout
Fleischtopf
Tacho

ref.	∅ (cm)	H (cm)	Lts	☰ (cm)	⊙ (cm)	📦	Bar Code
464120	20	8,50	2,20	13,50	±2	1/4	8411922458121
464124	24	11	4,30	17,50	±2	1/4	8411922458138
464128	28	12,50	6,40	22	±2	1/2	8411922458145



Excellent Titanio.

ALUMINIO FUNDIDO

CAST ALUMINUM
 FONTE D'ALUMINIUM
 ALUMINIUMGUSS
 ALUMÍNIO FUNDIDO



QuanTanium[®]
 Titanium-reinforced non-stick coating



- Asas Desmontables Silicona
- Full Induction
- Tapa de Cristal con Pomo de Acero Inoxidable
- Detachable Handles Silicone
- Full Induction
- Glass lid with stainless steel knob



Guisera

Stewing Pan
 Sauteuse
 Schmorpfanne
 Caçarola Baixa



ref.	∅ (cm)	H (cm)	Lts	☞ (cm)	☉ (cm)	☐	Bar Code
462024	24	6	2,80	21	±2	1/4	8411922439823
462028	28	6,50	4,20	25,30	±2	1/4	8411922439830
462032	32	7	5,90	28,80	±2	1/4	8411922439847
462036	36	7,50	8	31,80	±2	1/4	8411922439854
462040	40	8	10,50	36	±2	1/4	8411922439861



Cacerola

Casserole
 Faitout
 Fleischtopf
 Tacho



ref.	∅ (cm)	H (cm)	Lts	☞ (cm)	☉ (cm)	☐	Bar Code
462120	20	10,50	2,60	13,50	±2	1/4	8411922439878
462124	24	11,40	4,20	17,50	±2	1/4	8411922439885
462128	28	12,50	6,50	22	±2	1/4	8411922439892



Evolution.

ALUMINIO FUNDIDO

CAST ALUMINUM
FONTE D'ALUMINIUM
ALUMINIUMGUSS
ALUMÍNIO FUNDIDO

- Asas Desmontables Silicona
- Full Induction
- Tapa de Cristal con Pomo de Acero Inoxidable
- Detachable Handles Silicone
- Full Induction
- Glass lid with stainless steel knob



Guisera

Stewing Pan
Sauteuse
Schmorpfanne
Caçarola Baixa



ref.	∅ (cm)	H (cm)	Lts	☞ (cm)	⊙ (cm)	📦	Bar Code
461024	24	7,50	2,80	22	±2	1/4	8411922434729
461028	28	7,50	4	25	±2	1/4	8411922434736
461030	30	8,50	4,60	27	±2	1/2	8411922434743
461032	32	8,50	5,60	29	±2	1/2	8411922434750
461036	36	8,50	7,50	32	±2	1/2	8411922434767
461040	40	8,50	8,50	32,50	±2	1/2	8411922436228

Cacerola

Casserole
Faitout
Fleischtopf
Tacho



ref.	∅ (cm)	H (cm)	Lts	☞ (cm)	⊙ (cm)	📦	Bar Code
461120	20	9	2,30	17,50	±2	1/6	8411922434774
461124	24	11	4,20	22	±2	1/4	8411922434781
461128	28	12,50	6,60	25	±2	1/4	8411922434798

Cazo

SaucePan
Casserole
Stielkasserolle
Çaçarola



- Mango de Baquelita
- Con Pico Vertedor
- Bakelite Handle
- With Pour Spout

ref.	Ø (cm)	H (cm)	Lts	☐	Bar Code
461216	16	8,50	1,40	1/6	8411922434804

Asas de Silicona

Silicone Handles
Poignées en Silicone
Griffe aus Silikon
Pegas de Silicone



ref.	Ø (cm)	☐	Bar Code
461010	24-30	1/12/60	8411922436297
461011	32-36	1/12/60	8411922436303

Svea.

ACERO INOXIDABLE 18/10
STAINLESS STEEL 18/10
ACIER INOXYDABLE 18/10
ROSTFREIER STAHL 18/10
AÇO INOXIDÁVEL 18/10



Olla

Pot
Marmite
Gemüsetopf
Panela



ref.	Ø (cm)	H (cm)	☐	Bar Code
606216	16	12,50	1/8	8411922456141
606220	20	13,50	1/4	8411922456165
606222	22	14	1/4	8411922456172
606224	24	14,50	1/4	8411922456189
606228	28	16,50	1/2	8411922456202

Cacerola

Casserole
Faitout
Fleischtopf
Tacho



ref.	Ø (cm)	H (cm)	☐	Bar Code
606016	16	7,50	1/8	8411922456011
606020	20	8,50	1/4	8411922456035
606022	22	8,50	1/4	8411922456042
606024	24	9	1/4	8411922456059
606028	28	10	1/4	8411922456073

Guisera

Stewing Pan
Sauteuse
Schmorpfanne
Çaçarola Baixa



- Asas de Baquelita
- Tapa de Acero Inoxidable
- Bakelite Handles
- Stainless Steel Lid

ref.	Ø (cm)	H (cm)	Lts	☐	Bar Code
606320	20	4,50	1,30	1/8	8411922460391
606324	24	5	2,20	1/4	8411922470307
606328	28	5,50	3,40	1/4	8411922470314

Cazo

SaucePan
Casserole
Stielkasserolle
Çaçarola



ref.	Ø (cm)	H (cm)	☐	Bar Code
606112	12	6	1/10	8411922456097
606114	14	7	1/8	8411922456103
606116	16	7,50	1/8	8411922456110

Ebbe.

ACERO INOXIDABLE 18/10

STAINLESS STEEL 18/10
ACIER INOXYDABLE 18/10
ROSTFREIER STAHL 18/10
AÇO INOXIDÁVEL 18/10



- Acabado pulido-satinado
- Fundido sellado por impacto
- Asas de acero reforzado
- Marcaje interior de capacidad
- Polished-satin finish
- Impact-sealed cast
- Reinforced steel handles
- Internal capacity marking

NEW

Olla

Pot
Marmite
Gemüsetopf
Panela



+ INFO



ref.	∅ (cm)	H (cm)	🍲 (cm)	🌀 (cm)	📦	Bar Code
607718	18	13	16	±2	1/4	8411922475593
607720	20	13,50	18	±2	1/4	8411922475609
607722	22	14	20	±2	1/4	8411922475616
607724	24	14,50	21,80	±2	1/2	8411922475623
607726	26	15,50	24	±2	1/2	8411922475630
607728	28	16,50	26	±2	1/2	8411922475647
607732	32	17	29,30	±2	1/2	8411922475654





NEW

Cacerola

Casserole
Faitout
Fleischtopf
Tacho



ref.	∅ (cm)	H (cm)	≡ (cm)	⊗ (cm)	⊠	Bar Code
607518	18	8	16	±2	1/4	8411922475487
607520	20	8,50	18	±2	1/4	8411922475494
607522	22	8,50	20	±2	1/4	8411922475500
607524	24	9	21,80	±2	1/4	8411922475517
607526	26	9,50	24	±2	1/4	8411922475524
607528	28	10	26	±2	1/2	8411922475531
607532	32	12	29,30	±2	1/2	8411922475548

NEW

Cazo

Saucepan
Casserole
Stielkasserolle
Caçarola



ref.	∅ (cm)	H (cm)	≡ (cm)	⊗ (cm)	⊠	Bar Code
607614	14	7	12	±2	1/4	8411922475555
607616	16	7,50	14	±2	1/4	8411922475562
607618	18	9	16	±2	1/4	8411922475579
607620	20	10	18	±2	1/4	8411922475586

Noah.

ACERO INOXIDABLE 18/10

STAINLESS STEEL 18/10

ACIER INOXYDABLE 18/10

ROSTFREIER STAHL 18/10

AÇO INOXIDÁVEL 18/10



- **Asas de Acero Inoxidable**
- **Tapa de Acero Inoxidable**
- Stainless Steel Handles
- Stainless Steel Lid

Cacerola

Casserole
Faitout
Fleischtopf
Tacho



ref.	Ø (cm)	H (cm)	Lts	☐	Bar Code
605016	16	7,50	1,50	1/4	8411922088328
605018	18	8	2,04	1/8	8411922089257
605020	20	8,50	2,60	1/4	8411922088335
605022	22	8,50	3,20	1/4	8411922089264
605024	24	9	4	1/4	8411922088342
605026	26	9,50	5	1/2	8411922089271
605028	28	10	6,10	1/4	8411922088359
605032	32	12	9,60	1/4	8411922089288

Guisera

Stewing Pan
Sauteuse
Schmorpfanne
Caçarola Baixa



ref.	Ø (cm)	H (cm)	Lts	☐	Bar Code
605318	18	4,50	1,20	1/8	8411922089349
605320	20	4,50	1,40	1/8	8411922089356
605322	22	4,70	1,40	1/4	8411922090383
605324	24	5	2,20	1/4	8411922088441
605326	26	5	2,40	1/4	8411922089363
605328	28	5,50	3,40	1/4	8411922088458
605332	32	6	4,80	1/4	8411922088465

Olla

Pot
Marmite
Gemüsetopf
Panela



ref.	Ø (cm)	H (cm)	Lts	☐	Bar Code
605216	16	12,50	2,50	1/8	8411922088403
605218	18	13	3,30	1/6	8411922089301
605220	20	13,50	4,20	1/4	8411922088410
605222	22	14	5,30	1/4	8411922089318
605224	24	14,50	6,50	1/2	8411922088427
605226	26	15,50	8,20	1/4	8411922089325
605228	28	16,50	10,10	1/2	8411922088434
605232	32	17	13,70	1/2	8411922089332

Olla Superalta

Super Tall Pot
Marmite Super Haute
Hoher Gemüsetopf
Panela Super Alta



ref.	Ø (cm)	H (cm)	Lts	☐	Bar Code
605418	18	19	4,70	1	8411922441604
605420	20	20	6,20	1/2	8411922441611
605422	22	21,50	8	1/2	8411922441628
605424	24	22,50	10	1/2	8411922441635
605426	26	24	12,50	1	8411922441642
605428	28	25	15,10	1	8411922441659
605432	32	26	20	1	8411922441666

Cazo

SaucePan
Casserole
Stielkasserolle
Caçarola



ref.	Ø (cm)	H (cm)	Lts	☐	Bar Code
605112	12	6	0,70	1/12	8411922089295
605114	14	7	1	1/8	8411922088366
605116	16	7,50	1,50	1/8	8411922088373
605118	18	9	2,30	1/4	8411922088380





Cacerola

Casserole
 Faitout
 Fleischtopf
 Tacho



ref.	∅ (cm)	Lts	∩	Bar Code
662016	16	1,50	1/6	8411922202793
662018	18	2	1/6	8411922068962
662020	20	2,50	1/6	8411922202809
662022	22	3	1/6	8411922205602
662024	24	3,50	1/4	8411922202816
662026	26	5	1/4	8411922068979
662028	28	6,50	1/4	8411922202823
662032	32	10	1/4	8411922204476

Cacerola Vapor

Steam Casserole
 Faitout Cuit Vapeur
 Dampfkocher
 Tacho Vapor



• **Asas de Acero Inoxidable**

• **Tapa de Acero Inoxidable**

• **Stainless Steel Handles**

• **Stainless Steel Lid**

ref.	∅ (cm)	Lts	∩	Bar Code
663024	24	3,50	1	8411922203578

Olla

Pot
 Marmite
 Gemüsetopf
 Panela



ref.	∅ (cm)	Lts	∩	Bar Code
662216	16	2,50	1/6	8411922202885
662220	20	4,50	1/6	8411922202892
662222	22	5,50	1/6	8411922205619
662224	24	6,50	1/4	8411922202908
662228	28	10	1/4	8411922202915

Olla para Espárragos

Asparagus Pot
 Cuit-Asperges
 Spargeltopf
 Panela para Espargos



• **Tapa de Cristal**

• **Cestillo de Acero Inoxidable**

• **Glass Lid**

• **Stainless Steel Basket**

ref.	∅ (cm)	Lts	H (cm)	∩	Bar Code
664016	16	4	22	1/6	8411922455571

Cestillo Vapor

Steam Basket
 Panier à Vapeur
 Dampfkorb
 Cesto Vapor



ref.	∅ (cm)	∩	Bar Code
662524	24	1/4	8411922202946

Cazo

Saucepan
 Casserole
 Stielkasserolle
 Caçarola



ref.	∅ (cm)	Lts	∩	Bar Code
662112	12	0,70	1/6	8411922202830
662114	14	1	1/6	8411922202847
662116	16	1,50	1/6	8411922202854

Prisma.

ACERO INOXIDABLE 18%
 STAINLESS STEEL 18%
 ACIER INOXYDABLE 18% ACIER INOXYDABLE
 ROSTFREIER STAHL 18% ROSTFREIER STAHL
 AÇO INOXIDÁVEL 18% AÇO INOXIDÁVEL



Cazo

Saucepan
 Casserole
 Stielkasserolle
 Caçarola



- Con Pico Vertedor
- With Pour Spout

ref.	∅ (cm)	Lts	∅	Bar Code
665310	10	0,40	6/48	8411922068771
665312	12	0,60	6/48	8411922068788
665314	14	1	6/24	8411922068795
665316	16	1,50	6/24	8411922068801
665318	18	1,90	6	8411922068818

Cazuelita

Round Dish
 Plat Rond
 Runde Teller
 Prato para Rações



ref.	∅ (cm)	H (cm)	∅	Bar Code
665614	14	3,30	6/24	8411922076219
665616	16	3,50	6/24	8411922076226
665618	18	3,80	6/24	8411922076233

Clásica.

ACERO INOXIDABLE 18%
 STAINLESS STEEL 18%
 ACIER INOXYDABLE 18% ACIER INOXYDABLE
 ROSTFREIER STAHL 18% ROSTFREIER STAHL
 AÇO INOXIDÁVEL 18% AÇO INOXIDÁVEL



Cazo

Saucepan
 Casserole
 Stielkasserolle
 Caçarola



- Mango de Baquelita
- Con Pico Vertedor
- Bakelite Handle
- With Pour Spout

ref.	∅ (cm)	Lts	∅	Bar Code
665210	10	0,40	6/48	8411922161335
665212	12	0,60	6/48	8411922205831
665214	14	1	6/24	8411922205848
665216	16	1,50	6/24	8411922205855
665218	18	1,90	6	8411922208504
665220	20	2,40	6	8411922161342

Óptima.

ACERO INOXIDABLE
 STAINLESS STEEL
 ACIER INOXYDABLE
 ROSTFREIER STAHL
 AÇO INOXIDÁVEL



Bateria

Set
 Batterie
 Topfset
 Trem de 6 Peças

- Asas de Baquelita
- Tapa de Cristal
- Bakelite Handles
- Glass Lid



cms.	lts.	cms.	lts.
16	1,50	14	1,20
18	2,00	16	1,50
20	2,50		
22	3,00		

ref.	∅ (cm)	Lts	∅	Bar Code
000957	14+16+18+20+22+14+16	1,5+2+2,5+3+1,2+1,5	1/2	8411922435580

Induktion.

ACERO INOXIDABLE 18%

STAINLESS STEEL 18%

ACIER INOXYDABLE 18% ACIER INOXYDABLE

ROSTFREIER STAHL 18% ROSTFREIER STAHL

AÇO INOXIDÁVEL 18% AÇO INOXIDÁVEL



• Mango de Baquelita

• Bakelite Handle



Cazo

Saucepan
Casserole
Stielkasserolle
Çaçarola



ref.	∅ (cm)	H (cm)	∩	Bar Code
666010	10	5,70	6/48	8411922438659
666012	12	6,20	6/36	8411922438666
666014	14	7	6/24	8411922438673
666016	16	7,70	6/18	8411922438680
666018	18	8,50	6	8411922438697
666020	20	8,80	6	8411922438703

Cazo con Tapa

Saucepan with Lid
Casserole avec Couvercle
Stielkasserolle mit Deckel
Çaçarola com Tampa



ref.	∅ (cm)	H (cm)	∩	Bar Code
666214	14	7	6	8411922439038

Cazo Freidor

Fryer Saucepan
Casserole Friteuse
Frittier Stieltopf
Çaçarola Fritadeira



ref.	∅ (cm)	H (cm)	∩	Bar Code
666118	18	8,50	6	8411922438758

Cazuelita

Round Dish
Plat Rond
Runde Teller
Prato para Rações



ref.	∅ (cm)	H (cm)	📦	Bar Code
665814	14	3,30	6/24	8411922456899
665816	16	3,50	6/24	8411922456905
665818	18	3,80	6/24	8411922456912
665820	20	4	6/24	8411922456929
665824	24	4,50	6/24	8411922456936

Hervidor

Kettle
Bouilloire
Wasserkocher
Fervedor



ref.	∅ (cm)	H (cm)	📦	Bar Code
666310	10	10	6/24	8411922451764
666312	12	10	6/24	8411922439069
666314	14	11	6/18	8411922439076
666316	16	12	6/12	8411922439083

Freidora con Cestillo

Fryer with Basket
Friteuse avec Panier
Frittierpfopf mit Korb
Fritadeira com Cesto

ref.	∅ (cm)	H (cm)	Lts	📏 (cm)	📏 (cm)	📦	Bar Code
666424	24	10	4,50	20	±2	1/6	8411922448887



Freidora con Cestillo y Tapa

Fryer with Basket and Lid
Friteuse avec Panier et Couvercle
Frittierpfopf mit Frittierkorb und Deckel
Fritadeira com Cesto e Tampa

ref.	∅ (cm)	H (cm)	Lts	📏 (cm)	📏 (cm)	📦	Bar Code
666520	20	8,50	2	16	±2	1	8411922471212



Natura.

ALUMINIO FORJADO
FORGED ALUMINIUM
ALUMINIUM FORGÉ
GESCHMIEDETES ALUMINIUM
ALUMÍNIO FORJADO



Cacerola

Casserole
Faitout
Fleischtopf
Tacho



- Full Induction
- Asas de Baquelita
- Soft Touch
- Antiadherente Estilo Piedra
- Full Induction
- Bakelite Handles
- Soft Touch
- Stone Style Non-Stick Coating

ref.	∅ (cm)	H (cm)	Lts	📏 (cm)	📏 (cm)	📦	Bar Code
440420	20	8,50	2,60	14	±2	1/4	8411922093988
440424	24	10,50	4,70	18	±2	1/4	8411922093995
440428	28	12	6,40	22	±2	1/6	8411922436006

Olla

Pot
Marmite
Gemüsetopf
Panela



ref.	∅ (cm)	H (cm)	Lts	∪ (cm)	⊗ (cm)	📦	Bar Code
440520	20	13	4	14	±2	1/4	8411922094008
440524	24	15	6,70	18	±2	1/4	8411922094015

Cazo

SaucePan
Casserole
Stielkasserolle
Caçarola



ref.	∅ (cm)	H (cm)	Lts	∪ (cm)	⊗ (cm)	📦	Bar Code
440614	14	6,50	1	10,50	±2	1/6	8411922094022
440616	16	7,50	1,50	11,50	±2	1/6	8411922094039

Natura Copper.

ALUMINIO FORJADO
FORGED ALUMINUM
ALUMINIUM FORGÉ
GESCHMIEDETES ALUMINIUM
ALUMÍNIO FORJADO



Cacerola

Casserole
Faitout
Fleischtopf
Tacho



- Full Induction
- Asas de Acero Inoxidable
- Tapa de Cristal
- Antiadherente Estilo Piedra
- Full Induction
- Stainless Steel Handles
- Glass Lid
- Stone Style Non-Stick Coating

ref.	∅ (cm)	∪ (cm)	⊗ (cm)	📦	Bar Code
495420	20	16	±2	1/4	8411922442014
495424	24	19,80	±2	1/4	8411922442021
495428	28	22,40	±2	1/4	8411922442038

Olla

Pot
Marmite
Gemüsetopf
Panela



ref.	∅ (cm)	∪ (cm)	⊗ (cm)	📦	Bar Code
495520	20	16,20	±2	1/4	8411922442045
495524	24	19,60	±2	1/4	8411922442052

Cazo

SaucePan
Casserole
Stielkasserolle
Caçarola



ref.	∅ (cm)	H (cm)	∪ (cm)	⊗ (cm)	📦	Bar Code
495114	14	7	11	±2	1/6	8411922441314
495116	16	7,50	13	±2	1/6	8411922441321

Cocotte.

HIERRO FUNDIDO ESMALTADO

ENAMELED CAST IRON
 FONTE ÉMAILLÉE
 EMAILLIERTES GUSSEISEN
 FERRO FUNDIDO ESMALTADO



- Interior Esmaltado
- Pomo Acero Inoxidable
- Enamelled inside
- Stainless Steel Knob



Cocotte Oval

Oval Cocotte
 Cocotte Ovale
 Ovale Cocotte
 Cocotte Oval



ref.	L (cm)	W (cm)	H (cm)	Lts	📦	Bar Code
726027R	27	21	10	3,30	1/2	8411922437317

Cocotte Oval Mini

Mini Oval Cocotte
 Cocotte Ovale Mini
 Mini Ovale Cocotte
 Cocotte Oval Mini



ref.	L (cm)	W (cm)	H (cm)	Lts	📦	Bar Code
726015N	15	10	6	0,50	1/4	8411922082777
726015R	15	10	6	0,50	1/4	8411922082760

Cocotte Redonda

Round Cocotte
 Cocotte Ronde
 Runde Cocotte
 Cocotte Redonda



ref.	L (cm)	H (cm)	Lts	📦	Bar Code
725921R	21	10	2,70	1/4	8411922437294
725924R	24	11,50	3,90	1/2	8411922437300

Cocotte Redonda Mini

Mini Round Cocotte
 Cocotte Ronde Mini
 Mini Runde Cocotte
 Cocotte Redonda Mini



ref.	L (cm)	H (cm)	Lts	📦	Bar Code	
725910N	10	4,50	0,30	1/4	8411922082753	BLACK
725910R	10	4,50	0,30	1/4	8411922082746	RED
725913R	13	8	0,50	1/6	8411922437287	RED

Cacerola

Casserole
Faitout
Fleischtopf
Tacho



- Asas de Baquelita
- Tapa de Cristal
- Bakelite Handles
- Glass Lid

ref.	Ø (cm)	H (cm)	Lts	☐	Bar Code
410816	16	7,50	1,50	1/4	8411922081022
410820	20	8,50	2,70	1/4	8411922081039
410824	24	9	4	1/4	8411922081046
410828	28	10	6,20	1/4	8411922081053

Olla

Pot
Marmite
Gemüsetopf
Panela



ref.	Ø (cm)	H (cm)	Lts	☐	Bar Code
410916	16	12,50	2,50	1/4	8411922081060
410920	20	13,50	4,20	1/4	8411922081077
410924	24	14,50	6,50	1/4	8411922081084

Olla para Pasta

Pasta Pot
Marmite à Pâtes
Pastatopf
Panela para
Cozer Massa



ref.	Ø (cm)	H (cm)	Lts	☐ (cm)	☐ (cm)	☐	Bar Code
411522	22	15,50	5,60	14,80	±2	1/4	8411922449907

Hervidor

Boiler
Bouilloire
Wasserkocher
Fervedor



ref.	Ø (cm)	Lts	☐ (cm)	☐ (cm)	☐	Bar Code
411414	14	1,80	10,20	±2	6/12	8411922457094
411416	16	2,40	12,50	±2	6/12	8411922457100

Cazo

SaucePan
Casserole
Stielkasserolle
Caçarola



ref.	Ø (cm)	H (cm)	Lts	☐	Bar Code
411012	12	6	0,70	1/4	8411922081107
411014	14	7	1,10	1/4	8411922081114
411016	16	8	1,60	1/4	8411922081121
411018	18	9	2,30	1/4	8411922081138
411020	20	10	3,15	1/4	8411922081145

Cazo con Tapa

SaucePan with Lid
Casserole avec Couvercle
Stielkasserolle mit Deckel
Çaçarola com Tampa

- Mango de Baquelita
- Tapa de Cristal
- Bakelite Handle
- Glass Lid



ref.	∅ (cm)	Lts	H (cm)	∪ (cm)	⊗ (cm)	∩	Bar Code
406412	12	0,70	6/6	10	±2	6/12	8411922085020

Cazuelita

Round Dish
Plat Rond
Runde Schale
Tacho Baixo



ref.	∅ (cm)	H (cm)	∪ (cm)	⊗ (cm)	∩	Bar Code
▶ 405314	14	3,30	10	±2	6/12	8411922076851
405316	16	3,50	13	±2	6/18	8411922076868
405318	18	4,50	13	±2	6/18	8411922081633
405320	20	4,50	14,70	±2	6/18	8411922081640
405324	24	5	17,70	±2	6/18	8411922081657

Venus.

Cazo

Saucepan
Casserole
Stielkasserolle
Çaçarola

- Aluminio
- Mango de Baquelita
- Aluminium
- Bakelite Handle



ref.	∅ (cm)	Lts	∩	Bar Code
300214	14	0,90	6	8411922201147
300216	16	1,20	6	8411922201161

Cocotte Oval Black

Oval Cocotte Black
Cocotte Ovale Black
Cocotte Oval Black
Cocotte Oval Black



ref.	L (cm)	W (cm)	H (cm)		Bar Code
914534	36	26	13	1	8411922455779
914538	38	28	15	1	8411922454734
914542	42	32	15	1	8411922454741

Cacerola Volcán

Volcán Casserole
Faitout Volcán
Fleischtopf Volcán
Tacho Volcán



ref.	∅ (cm)	Lts		Bar Code
930116	16	1,50	6	8411922021165
930120	20	2,50	6	8411922021202
930124	24	4,50	6	8411922021240

Olla Volcán

Volcán Pot
Marmite Volcán
Gemüsetopf Volcán
Panela Volcán



- Asas Metálicas
- Tapa de Acero Esmaltado
- Metallic Handles
- Enamelled Steel Lid

ref.	∅ (cm)	H (cm)	Lts		Bar Code
930216	16	11	2	6	8411922022162
930220	20	-	3,50	4	8411922022209
930224	24	15	6	4	8411922022247
930228	28	22	9,80	4	8411922022285

Cazo Volcán

Volcán Saucepan
Casserole Volcán
Stielkasserolle Volcán
Caçarola Volcán



- Mango de Baquelita
- Bakelite Handle



ref.	∅ (cm)	Lts		Bar Code
930314	14	1	6	8411922023145

Cazo Promo

Promo Saucepan
Casserole Promo
Stielkasserolle Promo
Caçarola Promo



ref.	∅ (cm)	Lts		Bar Code
912612	12	0,60	12	8411922065022
912614	14	0,90	12	8411922065015
912616	16	1,40	12	8411922065039

Cazo con Pico Cónico

Conical Saucepan with Spout
Casserole Conique avec Bec Verseur
Konische Stielkasserolle mit Ausguss
Caçarola Cónica com Bico



- Con Pico Vertedor
- With Pour Spout

ref.	∅ (cm)	Lts		Bar Code
915012	12	0,60	12	8411922012125
915014	14	0,90	12	8411922012149
915016	16	1,30	12	8411922012163
915018	18	1,80	12	8411922027217

Acero Esmaltado.

Moules.



Olla para Mejillones

Mussel Pot
Marmite à Moules
Muscheltopf
Panela para Mexilhões

ref.	∅ (cm)	📦	Bar Code	
914618N	18	1/4	8411922451665	NEGRA
914618M	18	1/6	8411922452013	PEACH
914618V	18	1/6	8411922452020	MENTA
914618P	18	1/4	8411922451672	PETROL
914618B	18	1/6	8411922456820	BERENJENA
914618T	18	1/6	8411922456837	TURQUESA
914622N	22	1	8411922454659	NEGRA



TURQUESA



BERENJENA



NEGRA



PETROL



PEACH



MENTA

Cacerola Horno.

ALUMINIO PULIDO
POLISHED ALUMINUM
ALUMINIUM POLI
POLIERTES ALUMINIUM
ALUMÍNIO POLIDO



gas

0,6 mm

Cacerola Horno

Roasting Casserole
Faitout Four
Camping Backofen
Çaçarola Forno



ref.	∅ (cm)	Lts	📦	Bar Code
100626	26	3	1/6	8411922101263
100628	28	3,50	1/6	8411922101287
100630	30	4	1/6	8411922101300
100632	32	4,80	1/6	8411922076844

Base Cacerola Horno

Base for Roasting Casserole
Base Faitout Four
Basis für Camping Backofen
Base Çaçarola Forno



ref.	📦	Bar Code
100600	1/12/48	8411922101003

Varios.

Adaptador Inducción-Vitrocerámica

Induction-Vitroc ceramic Adapter
 Adaptateur Induction-Vitrocéramique
 Induktions-Vitrokeramik-Adapter
 Adaptador Indução-Vitroc erâmica



- Acero Inoxidable 18%
- Mango de Acero Inoxidable
- Stainless Steel 18%
- Stainless Steel Handle



ref.	Ø (cm)	📦	Bar Code
703714	14,50	4/12	8411922076875
703719	19	4/12	8411922068467
703724	24	4/12	8411922068474
703728	28	4/8	8411922075267

Adaptador Inducción-Vitroc erámica Eco

Eco Induction-Vitroc eramic Adapter
 Adaptateur Induction-Vitrocéramique Eco
 Induktions-Vitrokeramik-Adapter Eco
 Adaptador Indução-Vitroc erâmica Eco



- Acero Inoxidable 18%
- Material Tricapa (Inox-Alu-Inox)
- Stainless Steel 18%
- Three-Ply Material (Inox-Alu-Inox)



ref.	Ø (cm)	📦	Bar Code
705320	19,50	4/12	8411922451689
705324	23,50	4/12	8411922451696
705328	28	4/8	8411922451702

Adaptador de Inducción para Cafeteras

Induction Adaptor for Coffee Makers
 Adaptateur d'Induction pour Cafetières
 Induktionsadapter für espressokocher
 Adaptador Indução para Cafeteiras



- Acero Inoxidable 18%
- Mango de Baquelita
- Stainless Steel 18%
- Bakelite Handle



ref.	Ø (cm)	📦	Bar Code
705312	12	4/12	8411922452426

Difusor para Gas

Gas Diffuser
 Diffuseur pour Gaz
 Gasdiffusor
 Difusor para Gas



- Acero Estañado
- Mango Plegable
- Stainless Steel
- Folding Handle

ref.	Ø (cm)	📦	Bar Code
721221	21	6/48	8411922448979

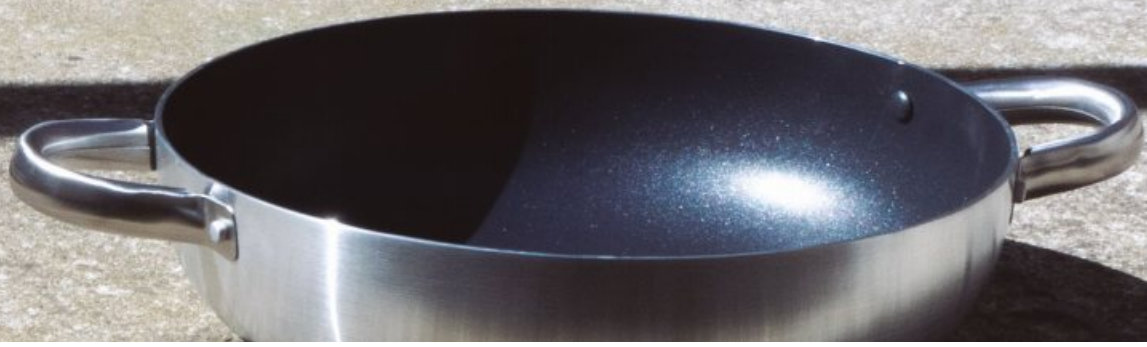

Cocedor Pasta / Espárragos Mango Abatible

Pasta / Asparagus Strainer with Collapsible Handle
 Cuisseur pour Pâtes / Asperges Poignée Pliante
 Nudel-/Spargelkocher Klappbarer Griff
 Cozedor para Massas / Espargos Pega Dobrável



- Acero Inoxidable
- Mango Plegable
- Stainless Steel
- Folding Handle



ref.	∅ (cm)	H (cm)		Bar Code
758510	13	14,50	1/6/18	8411922447033

Cestillo para Olla a Presión

Pressure Cooker Basket
 Panier pour Cocotte à Pression
 Schnellkochtopf-Korb
 Cesto para Panela de Pressão



- Acero Inoxidable 18%
- Stainless Steel 18%

ref.	∅ (cm)		Bar Code
743221	21	1/4	8411922435689

Cestillo para Olla con Asa

Basket for Pot with Handle
 Panier à Marmite avec Anse
 Korb für Gemüsetopf mit Griff
 Cesto para Panela com Asa



- Acero Inoxidable
- Stainless Steel

ref.	∅ (cm)	H (cm)		Bar Code
705510	14	10	1/6	8411922449525
705520	14	16	1/6	8411922449532
705530	16	16	1/6	8411922449549



Sartenes y Grills.



Frypans-Grills

Poêles-Grills

Pfannen-Grills

Frigideiras-Grelhadores

<u>Classe Titanium</u>	039	<u>I-Chef</u>	051
<u>Neo Blue</u>	039	<u>Gastronomy</u>	052
<u>Quarzo</u>	040	<u>New Induplus</u>	052
<u>Titan</u>	041	<u>Fusión</u>	054
<u>New Ecologic</u>	042	<u>Nova Ceram</u>	056
<u>Evolution</u>	042	<u>Inducta</u>	056
<u>Luxe</u>	042	<u>Indubasic</u>	058
<u>Titanio Chef</u>	043	<u>Chef Style</u>	060
<u>New Essential</u>	043	<u>Venus</u>	060
<u>Basic Stone</u>	044	<u>Artika</u>	060
<u>Lif</u>	044	<u>Blinis</u>	061
<u>Triply</u>	045	<u>Korinto</u>	061
<u>Triply Natural</u>	046	<u>Volcán</u>	061
<u>Natura</u>	047	<u>Moka</u>	062
<u>Natura Copper</u>	049	<u>MiniAlu</u>	063
<u>Sanna</u>	050	<u>Colorful</u>	064
<u>Bux</u>	050	<u>New Orange</u>	065
		<u>Accesorios</u>	066

Classe Titanium.

ALUMINIO FUNDIDO
CAST ALUMINUM
FONTE D'ALUMINIUM
ALUMINIUMGUSS
ALUMÍNIO FUNDIDO



PPG **QuanTanium**
Titanium-reinforced non-stick coating

Sartén

Frying Pan
Poêle
Bratpfanne
Frigideira

- Full Induction
- Mango de Baquelita
- Soft Touch
- Full Induction
- Bakelite Handle
- Soft Touch



ref.	∅ (cm)	H (cm)	☞ (cm)	⊙ (cm)	📦	Bar Code	
507518	18	5	13	±2	2/6	8411922453959	BLANCO
507520	20	5	15,40	±2	2/6	8411922453966	GRIS
507522	22	5	16,70	±2	2/6	8411922453973	AZUL CLARO
507524	24	5	17,70	±2	2/6	8411922453980	AZUL OSCURO
507526	26	6	19,80	±2	2/6	8411922453997	VERDE
507528	28	6	22	±2	2/6	8411922454000	AMARILLO
507530	30	6,50	24	±2	2/6	8411922454017	ROJO



18cm

20cm

22cm

24cm

26cm

28cm

30cm

Neo Blue.

ALUMINIO FUNDIDO
CAST ALUMINUM
FONTE D'ALUMINIUM
ALUMINIUMGUSS
ALUMÍNIO FUNDIDO



PPG **Xylan**® **ibili**
design

Sartén

Fry Pan
Pöele
Bratpfanne
Frigideira

- Mango de Baquelita
- Soft Touch
- Bakelite Handle
- Soft Touch



ref.	∅ (cm)	H (cm)	☞ (cm)	⊙ (cm)	📦	Bar Code	
464218	18	4,50	13	±2	2/6	8411922460049	
464220	20	5	14	±2	2/6	8411922460056	
464222	22	5,30	14,30	±2	2/6	8411922460063	
464224	24	5,50	15,60	±2	2/6	8411922460070	
464226	26	5,50	18	±2	2/6	8411922460087	
464228	28	6	19	±2	2/6	8411922460094	

Quarzo.

ALUMINIO FORJADO

FORGED ALUMINUM
ALUMINIUM FORGÉ
GESCHMIEDETES ALUMINIUM
ALUMÍNIO FORJADO



PPG QuanTanium[®]
Titanium-reinforced non-stick coating

- Full Induction
- Máxima Eficiencia Energética
- Mango de Acero Inoxidable
- Mango Remachado
- Antiadherente Estilo Piedra
- Full Induction
- Maximum Energy Efficiency
- Stainless Steel Handle
- Riveted Handle
- Stone Style Non-Stick Coating

Sartén

Frying Pan
Poêle
Bratpfanne
Frigideira



ref.	∅ (cm)	H (cm)	Lts	☞ (cm)	⊙ (cm)	📦	Bar Code
600018	18	4	1	13,50	±2	3/6	8411922422009
600020	20	4	1	15,50	±2	3/6	8411922422016
600022	22	5	2	17,20	±2	3/6	8411922422023
600024	24	5	2	19	±2	3/6	8411922422030
600026	26	5	3	21	±2	3/6	8411922422047
600028	28	5	3	22,30	±2	3/6	8411922422054
600030	30	6	4	24	±2	3/6	8411922422061

NEW

Wok

Wok
Wok
Wok
Wok



**PFAS
FREE.**

ref.	∅ (cm)	H (cm)	☞ (cm)	⊙ (cm)	📦	Bar Code
600230	30	8,50	17,60	±2	3/6	8411922476057

NEW

Sartén Honda

Deep Frying Pan
Poêle Profonde
Tiefe Bratpfanne
Frigideira Funda



**PFAS
FREE.**

ref.	∅ (cm)	H (cm)	☞ (cm)	⊙ (cm)	📦	Bar Code
600324	24	7,50	18,80	±2	3/6	8411922476064
600328	28	8	21,50	±2	3/6	8411922476071

NEW

Grill

Grill
Grill
Grillpfanne
Grelhador

**PFAS FREE.**

ref.	L (cm)	W (cm)	H (cm)	☺ (cm)	☹ (cm)	☐	Bar Code
600628	28	28	4	20	±2	3/6	8411922476095

NEW

Crepiera

Pancake Pan
Poêle à Crêpes
Crêpe Pfanne
Crepiera

**PFAS FREE.**

ref.	∅ (cm)	H (cm)	☺ (cm)	☹ (cm)	☐	Bar Code
600425	25	2	22,40	±2	3/6	8411922476088

Titan.

ALUMINIO FUNDIDO
CAST ALUMINUM
FONTE D'ALUMINIUM
ALUMINIUMGUSS
ALUMÍNIO FUNDIDO



PPG Xylan® ibili design

Sartén

Frying Pan
Poêle
Bratpfanne
Frigideira



ref.	∅ (cm)	H (cm)	☺ (cm)	☹ (cm)	☐	Bar Code
465018	18	4,80	12,70	±2	3/6	8411922433890
465020	20	5,30	14,40	±2	3/6	8411922433906
465022	22	5,40	16,10	±2	3/6	8411922433913
465024	24	5,50	18	±2	3/6	8411922433920
465026	26	6	19,50	±2	3/6	8411922433937
465028	28	6	21,0	±2	3/6	8411922433944
465030	30	6,70	22,70	±2	3/6	8411922433951
465032	32	6,50	23,50	±2	2/4	8411922436334

Crepiera

Pancake Pan
Poêle à Crêpes
Crêpe Pfanne
Crepeira



- Full Induction
- Máxima Eficiencia Energética
- Mango de Acero Inoxidable
- Full Induction
- Maximum Energy Efficiency
- Stainless Steel Handle

ref.	∅ (cm)	H (cm)	☺ (cm)	☹ (cm)	☐	Bar Code
465222	22	2	18,10	±2	3/6	8411922454505
465226	26	2	22	±2	3/6	8411922436556

Grill con Mango

Grill with Handle
Grill avec Manche
Grillpfanne mit Stiel
Grelhador com Cabo



ref.	L (cm)	W (cm)	H (cm)	☐	Bar Code
465128	28	28	4	4	8411922436327

Wok

Wok
Wok
Wok
Wok



ref.	∅ (cm)	H (cm)	☺ (cm)	☹ (cm)	☐	Bar Code
465330	30	9	19	±2	2/4	8411922436563

New Ecologic.

ACERO INOXIDABLE
STAINLESS STEEL
ACIER INOXYDABLE
ROSTFREIER STAHL
AÇO INOXIDÁVEL



PPG Xylan®

Sartén

Frying Pan
Poêle
Bratpfanne
Frigideira



• Mango de Baquelita

- Soft Touch
- Bakelite Handle
- Soft Touch



ref.	Ø (cm)	H (cm)	Lts	☞ (cm)	☉ (cm)	☐	Bar Code
601514N	14	3,50	0,50	11,50	±2	6	8411922441949

Evolution.

ALUMINIO FUNDIDO
CAST ALUMINUM
FONTE D'ALUMINIUM
ALUMINIUMGUSS
ALUMÍNIO FUNDIDO



Sartén

Frying Pan
Poêle
Bratpfanne
Frigideira



• Mango de Baquelita

- Soft Touch
- Bakelite Handle
- Soft Touch

ref.	Cms	H (cm)	Lts	☐	Bar Code
461318	18	4,50	0,80	3/6	8411922436358
461320	20	4,70	1,10	3/6	8411922436365
461322	22	5	1,40	3/6	8411922436372
461324	24	5,30	1,80	3/6	8411922436389
461326	26	5,50	2,30	3/6	8411922436396
461328	28	5,70	2,90	3/6	8411922436402
461330	30	6	3,40	3/6	8411922436419

Luxe.

ALUMINIO FORJADO
FORGED ALUMINUM
ALUMINIUM FORGÉ
GESCHMIEDETES ALUMINIUM
ALUMÍNIO FORJADO



Wok

Wok
Wok
Wok
Wok



• Mango de Madera

- Tapa de Cristal con Borde de Silicona
- Wooden Handle
- Glass Lid with Silicone Rim

ref.	Ø (cm)	H (cm)	☐	Bar Code
404230	30	8,5-12	1/2	8411922454512

Sartén para Tortillas

Omelette Pan
Poêle à Tortilla
Tortilla Pfanne
Frigideira para Tortilhas



- Acero Inoxidable
- Full Induction
- Mango de Acero Inoxidable
- Mango Desmontable de Silicona
- Stainless Steel
- Full Induction
- Stainless Steel Handle
- Detachable Silicone Handle

ref.	Ø (cm)	H (cm)	📦	Bar Code
490126	26	6	4	8411922441758

Wok

Wok
Wok
Wok
Wok



Funda de Silicona

Silicone Sheath
Housse en Silicone
Silikonmantel
Capa de Silicone



- Universal
- Universal

ref.	Ø (cm)	H (cm)	📏 (cm)	🌀 (cm)	📦	Bar Code
490230	30	9,50	19	±2	4	8411922446807

ref.	L (cm)	📦	Bar Code
490000	13	3/6/60	8411922441178

New Essential.

Grill Plancha

Grill Plancha
Plancha à Griller
Grillplatte
Grelhador Chapa



- Full Induction
- Asas Desmontables Silicona
- Full Induction
- Detachable Handles Silicone

ref.	L (cm)	W (cm)	H (cm)	📦	Bar Code
409127	27	24	2	2/4	8411922454116
409133	33	24	2	2/4	8411922454123

Grill Plancha Liso

Flat Grill Pan
Plancha à Griller Lisse
Grillplatte Glatt
Grelhador Chapa Liso



- Asas Desmontables Silicona
- Antiadherente Estilo Piedra
- Detachable Handles Silicone
- Stone Style Non-Stick Coating

ref.	L (cm)	W (cm)	H (cm)	☐	Bar Code
409523	36	23	3,20	1/6	8411922435054
409529	47	29	3,70	1/6	8411922435061

Grill Plancha Ondulada

Ridged Grill Pan
Plancha à Griller Ondulé
Grillplatte Gewellt
Grelhador Chapa Ondulada



- Asas Desmontables Silicona
- Antiadherente Estilo Piedra
- Detachable Handles Silicone
- Stone Style Non-Stick Coating

ref.	L (cm)	W (cm)	H (cm)	☐	Bar Code
406023	36	23	3,20	1/6	8411922437195
406029	47	29	3,70	1/6	8411922437201

Grill Liso

Plain Grill
Gril Lisse
Grillpfanne Glatt
Grelhador Liso



- Full Induction
- Asa de Madera Plegable
- Full Induction
- Wooden Folding Handle

ref.	L (cm)	W (cm)	H (cm)	☐ (cm)	☉ (cm)	☐	Bar Code
407020	20	20	3,40	15	±2	6	8411922458374
407024	24	24	3,75	17,40	±2	6	8411922458381
407028	28	28	3,85	20,60	±2	6	8411922458398

Grill Ondulado

Waved Grill
Gril Ondulé
Grillpfanne Gewellt
Grelhador Ondulado



- Full Induction
- Asa de Madera Plegable
- Full Induction
- Wooden Folding Handle

ref.	L (cm)	W (cm)	H (cm)	☐ (cm)	☉ (cm)	☐	Bar Code
407520	20	20	3,40	15	±2	6	8411922458404
407524	24	24	3,75	17,40	±2	6	8411922458411
407528	28	28	3,85	20,60	±2	6	8411922458428

Triply.

ACERO INOXIDABLE. ALUMINIO

STAINLESS STEEL. ALUMINIUM

ACIER INOXYDABLE. ALUMINIUM

ROSTFREIER STAHL. ALUMINIUM

AÇO INOXIDÁVEL. ALUMÍNIO

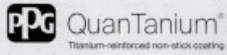

- Máxima Eficiencia Energética
- Material Tricapa (Inox 18/10-Alu-Inox 18%)
- Maximum Energy Efficiency
- Three-Ply Material (Inox 18/10-Alu-Inox 18%)

3 CAPAS

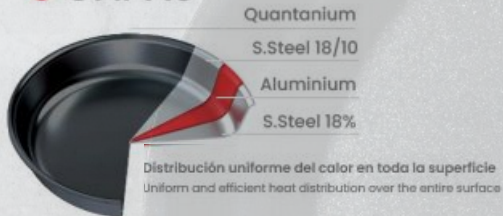

Sartén

Frying Pan

Poêle

Bratpfanne

Frigideira

ref.	Ø (cm)	H (cm)	☞ (cm)	⊙ (cm)	📦	Bar Code
652818	18	4,30	12,80	±2	3/6	8411922458763
652820	20	4,50	14,80	±2	3/6	8411922458770
652822	22	4,70	15,70	±2	3/6	8411922458787
652824	24	5	19,30	±2	3/6	8411922458794
652826	26	5	21,50	±2	3/6	8411922458800
652828	28	5,40	22,50	±2	3/6	8411922458817



Triply Natural.

ACERO INOXIDABLE. ALUMINIO

STAINLESS STEEL. ALUMINIUM

ACIER INOXYDABLE. ALUMINIUM

ROSTFREIER STAHL. ALUMINIUM

AÇO INOXIDÁVEL. ALUMÍNIO



induction



vitro



electric



gas



3
High resistance
aluminium

- Material Tricapa (Inox 18/10-Alu-Inox 18%)
- Sin recubrimiento antiadherente (NO PTFE)
- Three-Ply Material (Inox 18/10-Alu-Inox 18%)
- Non-stick coating free (PTFE FREE)

3 CAPAS



S.Steel 18/10

Aluminium

S.Steel 18%

Distribución uniforme del calor en toda la superficie
Uniform and efficient heat distribution over the entire surface

Sartén

Frying Pan
Poêle
Bratpfanne
Frigideira



ref.	∅ (cm)	H (cm)	∩ (cm)	⊙ (cm)	📦	Bar Code
652918	18	4,30	12,80	±2	3/6	8411922476330
652920	20	4,50	14,80	±2	3/6	8411922474305
652922	22	4,80	15,70	±2	3/6	8411922476347
652924	24	5,00	19,30	±2	3/6	8411922474312
652926	26	5,30	21,50	±2	3/6	8411922476354
652928	28	5,40	22,50	±2	3/6	8411922474329

NEW

Sautex

Stewing Pan
Sauteuse
Schmorpfanne
Caçarola Baixa



ref.	∅ (cm)	H (cm)	∩ (cm)	⊙ (cm)	📦	Bar Code
653024	24	7	21	±2	2/4	8411922476019
653028	28	7	23	±2	2/4	8411922476026

NEW

Wok

Wok
Wok
Wok
Wok



ref.	∅ (cm)	H (cm)	∩ (cm)	⊙ (cm)	📦	Bar Code
653130	30	9	13	±2	3/6	8411922476033

NEW

Grill

Square Grill
Grill Carré
Grillpfanne
Grelhador Quadrado



ref.	L (cm)	W (cm)	H (cm)	∩ (cm)	⊙ (cm)	📦	Bar Code
653228	28	28	4	26,5x26,5	±2	3/6	8411922476040

Natura.

ALUMINIO FORJADO
 FORGED ALUMINUM
 ALUMINIUM FORGÉ
 GESCHMIEDETES ALUMINIUM
 ALUMÍNIO FORJADO



Sartén

Frying Pan
 Poêle
 Bratpfanne
 Frigideira



- Mango de Baquelita
- Antiadherente Estilo Piedra
- Bakelite Handle
- Stone Style Non-Stick Coating

ref.	∅ (cm)	H (cm)	☞ (cm)	⊙ (cm)	📦	Bar Code
440014	14	4	10,20	±2	12/24	8411922091380
440016	16	4,40	11,50	±2	6	8411922433777
440018	18	4,10	13	±2	6	8411922089646
440020	20	4,50	15	±2	6	8411922089653
440022	22	4,70	16,50	±2	6	8411922089660
440024	24	5	18	±2	6	8411922089677
440026	26	5,30	20	±2	6	8411922089684
440028	28	5,50	21,50	±2	6	8411922089691
440030	30	5,70	23,80	±2	6	8411922089707

Sartén Honda con Asas

Deep Frying Pan with Handles
 Poêle Profonde avec Anses
 Tiefe Bratpfanne mit Griffe
 Frigideira Funda com Asas



ref.	∅ (cm)	H (cm)	☞ (cm)	⊙ (cm)	📦	Bar Code
440832	32	7,80	22,50	±2	4	8411922094077
440828	28	7,50	19	±2	4	8411922094060

Sartén Honda con Mango

Deep Frying Pan with Handle
 Poêle Profonde avec Manche
 Tiefe Bratpfanne mit Stiel
 Frigideira Funda com Cabo



ref.	∅ (cm)	H (cm)	☞ (cm)	⊙ (cm)	📦	Bar Code
440724	24	6,50	15,50	±2	6	8411922094046
440728	28	7,50	19	±2	6	8411922094053

Wok

Wok
 Wok
 Wok
 Wok



ref.	∅ (cm)	H (cm)	Lts	☞ (cm)	⊙ (cm)	📦	Bar Code
441124	24	7	2,30	14,20	±2	6	8411922459746
441130	30	9	3,70	21	±2	6	8411922441383

Sartén para Tortillas

Omelette Pan
 Poêle à Tortilla
 Tortilla Pfanne
 Frigideira para Tortilhas



ref.	∅ (cm)	H (cm)	☞ (cm)	⊙ (cm)	📦	Bar Code
441020	20	9,30	14,40	±2	4	8411922435283
441024	24	9,50	18	±2	4	8411922435290



Grill Ondulado

Ridged Grill
Grill Ondulé
Grillpfanne Gewellt
Gelhador Ondulado



ref.	L (cm)	W (cm)	H (cm)	☞ (cm)	☉ (cm)	☐	Bar Code
440128	28	28	4,50	19	±2	6	8411922091397

NEW

Grill Liso

Plain Grill
Grill Lisse
Grillpfanne Glatt
Grelhador Liso



ref.	L (cm)	W (cm)	H (cm)	☞ (cm)	☉ (cm)	☐	Bar Code
441226	26	26	4,50	17,80	±2	6	8411922475128

Crepiera 6 Minicrepes Corazón

6 Hearts Mini Pancake Pan
Poêle à Crêpes 6 Coeurs
6 Herzen Mini Crêpe Pfanne
Crepeira de 6 Mini Crepes
Coraçao



ref.	☉ (cm)	H (cm)	☐	Bar Code
400206	28	1,50	6	8411922457797

Crepiera 7 Minicrepes Emojis

7 Emojis Mini Pancake Pan
Poêle à Crêpes 7 Emojis
7 Emoji Mini Crêpe Pfanne
Crepeira de 7 Mini Crepes
Emojis



ref.	☉ (cm)	☉ (cm)	H (cm)	☐	Bar Code
400207	28	8	1,50	6	8411922448559

Crepiera 4 Minicrepes / Huevos

4 Mini Pancake / Eggs Pan
Poêle à 4 Mini Crêpes / Oeuf
4 Mini Pancake / Eier Pfanne
Crepeira de 4 Mini Crepes
/ Ovos



ref.	☉ (cm)	☉ (cm)	H (cm)	☐	Bar Code
400204	26	10	1,50	6	8411922448542

Crepiera

Pancake Pan
Poêle à Crêpes
Crêpe Pfanne
Crepeira



ref.	☉ (cm)	H (cm)	☞ (cm)	☉ (cm)	☐	Bar Code
440225	25	2	19	±2	6	8411922091595
440228	28	2	22	±2	6	8411922091601

Sartén

Frying Pan
Poêle
Bratpfanne
Frigideira



- **Mango de Acero Inoxidable**
- **Stainless Steel Handle**

ref.	∅ (cm)	H (cm)	☰ (cm)	⊙ (cm)	📦	Bar Code
495016	16	4	12	±2	6	8411922441239
495018	18	4	14	±2	6	8411922441246
495020	20	4,20	16	±2	6	8411922441253
495022	22	4,20	17	±2	6	8411922441260
495024	24	4,70	18	±2	6	8411922441277
495026	26	5	20,50	±2	6	8411922441284
495028	28	5	22	±2	6	8411922441291
495030	30	5	23,80	±2	6	8411922441307

Sartén Honda con Mango

Deep Frying Pan with Handle
Poêle Profonde avec Manche
Tief Bratpfanne mit Stiel
Serta Funda com Cabo



ref.	∅ (cm)	H (cm)	☰ (cm)	⊙ (cm)	📦	Bar Code
495324	24	7	18	±2	6	8411922441345
495328	28	7,50	21,50	±2	6	8411922441352

Sartén Honda con Asas

Deep Frying Pan with Handles
Poêle Profonde avec Anses
Tief Bratpfanne mit Griffe
Frigideira Funda com Asas



ref.	∅ (cm)	H (cm)	☰ (cm)	⊙ (cm)	📦	Bar Code
495628	28	7,50	21,50	±2	4	8411922442069
495632	32	7,80	22,50	±2	4	8411922442076

Grill

Grill
Grill
Grillpfanne
Grelhador



ref.	L (cm)	W (cm)	H (cm)	☰ (cm)	⊙ (cm)	📦	Bar Code
495228	28	28	4,20	19	±2	6	8411922441338

Sanna.

ALUMINIO FORJADO
FORGED ALUMINUM
ALUMINIUM FORGÉ
GESCHMIEDETES ALUMINIUM
ALUMÍNIO FORJADO



PPG Xylan® Plus
Reliable long-life non-stick coating

Sartén

Frying Pan
Poêle Sanna
Bratpfanne
Frigideira



- Mango de Baquelita
- Soft Touch
- Bakelite Handle
- Soft Touch

ref.	∅ (cm)	H (cm)	☞ (cm)	⊙ (cm)	☐	Bar Code
482518	18	4,30	14,40	±2	6	8411922458664
482520	20	4,50	15	±2	6	8411922458671
482522	22	4,70	17,10	±2	6	8411922458688
482524	24	5	19,10	±2	6	8411922458695
482526	26	5,50	21	±2	6	8411922458701
482528	28	5,50	23,10	±2	6	8411922458718
482530	30	5,80	25	±2	6	8411922458725

Bux.

ALUMINIO
ALUMINIUM
ALUMINIUM
ALUMINIUM
ALUMÍNIO



PPG Xylan®

Sartén

Frying Pan
Poêle
Bratpfanne
Frigideira



- Mango de Baquelita
- Soft Touch
- Bakelite Handle
- Soft Touch

ref.	∅ (cm)	H (cm)	☞ (cm)	⊙ (cm)	☐	Bar Code
505016	16	4	10,20	±2	6	8411922452877
505018	18	4,40	11,20	±2	6	8411922452884
505020	20	4,40	13,30	±2	6	8411922452891
505022	22	5	14,40	±2	6	8411922452907
505024	24	5,40	15,40	±2	6	8411922452914
505026	26	5,90	16,40	±2	6	8411922452921
505028	28	5,90	18	±2	6	8411922452938
505030	30	5,90	19,50	±2	6	8411922452945

Grill

Grill
Grill
Grillpfanne
Grelhador



Sartén para Tortillas

Omelette Pan
Poêle à Tortilla
Tortilla Pfanne
Frigideira para Tortilhas



ref.	L (cm)	W (cm)	H (cm)	☞ (cm)	⊙ (cm)	☐	Bar Code
505126	26	26	4,50	18	±2	6	8411922457070

ref.	∅ (cm)	H (cm)	☞ (cm)	⊙ (cm)	☐	Bar Code
505220	20	5,4+4,4	14,40	±2	4	8411922457803
505224	24	5,5+4,5	18	±2	4	8411922457810

Sartén

Frying Pan
Poêle
Bratpfanne
Frigideira



ref.	∅ (cm)	H (cm)	☰ (cm)	⊗ (cm)	📦	Bar Code
403018	18	4	12	±2	6	8411922082975
403020	20	4,50	12	±2	6	8411922082982
403022	22	5	15	±2	6	8411922082999
403024	24	5	16	±2	6	8411922083002
403026	26	5,50	17	±2	6	8411922083019
403028	28	6	19	±2	6	8411922083026
403030	30	6	19	±2	6	8411922083033
403032	32	6,50	19	±2	6	8411922083040
403036	36	6,50	22	±2	4	8411922436341

Sartén Honda con Mango

Deep Frying Pan with Handle
Poêle Profonde avec Manche
Tief Bratpfanne mit Stiel
Frigideira Funda com Cabo

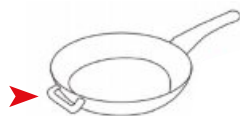

ref.	∅ (cm)	H (cm)	☰ (cm)	⊗ (cm)	📦	Bar Code
403124	24	7,70	14,50	±2	6	8411922083897
403128	28	8,10	17,50	±2	6	8411922083903
403132	32	8,40	19	±2	6	8411922083910

Sartén Honda con 2 Asas

Deep Frying Pan with 2 Handles
Poêle Profonde avec 2 Anses
Tief Bratpfanne mit 2 Griffe
Frigideira Funda com 2 Asas



ref.	∅ (cm)	H (cm)	☰ (cm)	⊗ (cm)	📦	Bar Code
403328	28	8,10	17,50	±2	6	8411922083941
403332	32	8,40	19	±2	6	8411922083958
403336	36	10	22	±2	6	8411922083965
403340	40	12	-	-	4	8411922083972

▶ NO INDUCCIÓN

Sartén para Tortillas

Omelette Pan
Poêle à Omelette
Tortilla-Pfanne
Frigideira para Tortilhas



ref.	∅ (cm)	H (cm)	☰ (cm)	⊗ (cm)	📦	Bar Code
403414	14	5	11	±2	6	8411922474428





Sartén

Frying Pan
Poêle
Bratpfanne
Frigideira



• Mango de Acero Inoxidable

• Stainless Steel Handle

ref.	∅ (cm)	H (cm)	📦	Bar Code
500418	18	4,30	6	8411922453133
500420	20	4,40	6	8411922453140
500422	22	4,40	6	8411922453157
500424	24	5	6	8411922453164
500426	26	5,20	6	8411922453171
500428	28	5,70	6	8411922453188
500430	30	5,80	6	8411922453195
500432	32	6	6	8411922453201
500436	36	6,20	4	8411922453218

Sartén Honda con Mango

Deep Fry Pan with Handle
Poêle Profonde avec Manche
Tiefe Bratpfanne mit Stiel
Frigideira Funda com Cabo



Sartén Honda con Asas

Deep Fry Pan with Handles
Poêle Profonde avec Anses
Tiefe Bratpfanne mit Griffe
Frigideira Funda com Asas



ref.	∅ (cm)	H (cm)	📦	Bar Code
500520	20	7	6	8411922455632
500524	24	8	6	8411922455649
500528	28	8	6	8411922455656
▶ 500532	32	8,50	4	8411922457292

ref.	∅ (cm)	H (cm)	📦	Bar Code
500624	24	8	6	8411922457308
500628	28	8	6	8411922457315
500632	32	8,50	4	8411922457322

New Induplus.

ALUMINIO FORJADO
FORGED ALUMINUM
ALUMINIUM FORGÉ
GESCHMIEDETES ALUMINIUM
ALUMÍNIO FORJADO



Sartén

Frying Pan
Poêle
Bratpfanne
Frigideira



ref.	∅ (cm)	H (cm)	📏 (cm)	⊙ (cm)	📦	Bar Code
400016N	16	4,40	11,70	±2	6	8411922436037
400018N	18	4,70	13,30	±2	6	8411922436044
400020N	20	5	14,40	±2	6	8411922436051
400022N	22	5,30	16,40	±2	6	8411922436068
400024N	24	5,60	18,20	±2	6	8411922436075
400026N	26	5,90	19,50	±2	6	8411922436082
400028N	28	6,20	20,80	±2	6	8411922436099
400030N	30	6,50	22	±2	6	8411922436105

Sartén Honda

Deep Frying Pan
Poêle Profonde
Tiefe Bratpfanne
Frigadeira Funda



ref.	Ø (cm)	H (cm)	Lts	☞ (cm)	☞ (cm)	☐	Bar Code
400124N	24	7	2,60	18	±2	6	8411922447576
400128N	28	7,50	3,80	20,30	±2	6	8411922447583

Wok

Wok
Wok
Wok
Wok



ref.	Ø (cm)	H (cm)	Lts	☞ (cm)	☞ (cm)	☐	Bar Code
400528N	28	8	3,60	15,40	±2	6	8411922447590

Sartén con Tapa Volteatortillas

Frying Pan with Omelette Flipper Lid
Poêle avec Couvercle pour Retourner Omelette
Bratpfanne mit Omelette Wendedeckel
Frigadeira com Tampo para Voltar Tortilhas



ref.	Ø (cm)	H (cm)	☞ (cm)	☞ (cm)	☐	Bar Code
400626N	26	7	19,50	±2	4	8411922452501

Grill

Grill
Grill
Grillpfanne
Grelhador



ref.	L (cm)	W (cm)	H (cm)	☞ (cm)	☞ (cm)	☐	Bar Code
400328N	28	28	5	23,60	±2	6	8411922437805

Grill con Pico

Grill with Spout
Grill avec Bec Verseur
Grillpfanne mit Ausguss
Grelhador com Bico



ref.	L (cm)	W (cm)	H (cm)	☞ (cm)	☞ (cm)	☐	Bar Code
400318N	18	18	4	12,50	±2	6	8411922456233

Crepiera

Pancake Pan
Poêle à Crêpes
Crêpe Pfanne
Crepeira



ref.	Ø (cm)	H (cm)	☞ (cm)	☞ (cm)	☐	Bar Code
400428N	28	2	22,70	±2	6	8411922457087

Fusión.

ALUMINIO

ALUMINIUM
ALUMINIUM
ALUMINIUM
ALUMÍNIO



• Mango de Baquelita

• Soft Touch

- Bakelite Handle
- Soft Touch



Sartén

Frying Pan
Poêle
Bratpfanne
Frigideira

ref.	Ø (cm)	H (cm)	☺ (cm)	☹ (cm)	📦	Bar Code
450016	16	4	11	±2	6	8411922092363
450018	18	4,20	12	±2	6	8411922092370
450020	20	4,30	13	±2	6	8411922092387
450022	22	4,70	14,50	±2	6	8411922092394
450024	24	5	15,50	±2	6	8411922092400
450026	26	5,50	17	±2	6	8411922092417
450028	28	5,80	17,50	±2	6	8411922092424
450030	30	5,80	19	±2	6	8411922092431



Sartén para Tortillas

Omelette Pan
Poêle à Tortilla
Tortilla Pfanne
Frigideira para Tortilhas

ref.	Ø (cm)	H (cm)	☺ (cm)	☹ (cm)	📦	Bar Code
451320	20	9	16,40	±2	4	8411922452396
451324	24	9,50	18,10	±2	4	8411922452402



Sartén Honda con Mango

Deep Frying Pan with Handle
Poêle Profonde avec Manche
Tiefe Bratpfanne mit Stiel
Frigideira Funda com Cabo



ref.	∅ (cm)	H (cm)	☰ (cm)	⊗ (cm)	📦	Bar Code
450820	20	7	12	±2	6	8411922451559
450824	24	7	14,50	±2	6	8411922451566
450826	26	7,80	14,80	±2	6	8411922451573
450828	28	8,10	17,50	±2	6	8411922451580

Sartén Honda con Asas

Deep Frying Pan with Handles
Poêle Profonde avec Anses
Tiefe Bratpfanne mit Griffe
Frigideira Funda com Asas



ref.	∅ (cm)	H (cm)	☰ (cm)	⊗ (cm)	📦	Bar Code
450924	24	7,70	14,50	±2	6	8411922451597
450928	28	8,10	17,50	±2	6	8411922451603
450932	32	8,40	19	±2	6	8411922451610
450936	36	10	19	±2	6	8411922451627

Set Sartén 20+24

Set Frying Pans 20+24
Jeu Poêle 20+24
Set Bratpfanne 20+24
Jogo Frigideira 20+24



ref.	∅ (cm)	☰ (cm)	⊗ (cm)	📦	Bar Code
450100	20+24	13+15,50	±2	6	8411922093810

Freidora con Cestillo

Frying Pan with Basket
Poêle à Fire avec Panier
Fritierpfanne mit Korb
Fritadeira com Cesto



- Cestillo de Acero Inoxidable
- Stainless Steel Basket

ref.	∅ (cm)	H (cm)	☰ (cm)	⊗ (cm)	📦	Bar Code
451026	26	7,80	14,80	±2	6	8411922451634

Grill

Grill
Grill
Grillpfanne
Gelhador



ref.	L (cm)	W (cm)	H (cm)	☰ (cm)	⊗ (cm)	📦	Bar Code
450226	26	26	4	17,70	±2	6	8411922436570

Crepiera

Pancake Pan
Poêle à Crêpes
Crêpe Pfanne
Crepeira



ref.	∅ (cm)	H (cm)	☰ (cm)	⊗ (cm)	📦	Bar Code
451222	22	1,50	15,20	±2	6	8411922452372
451226	26	2	17	±2	6	8411922452389

Nova Ceram.

ALUMINIO FORJADO
FORGED ALUMINIUM
ALUMINIUM FORGÉ
GESCHMIEDETES ALUMINIUM
ALUMÍNIO FORJADO



NEW

Sartén

Frying Pan
Poêle
Bratpfanne
Frigideira



- Full Induction
- Mango de baquelita soft touch
- Full Induction
- Soft touch bakelite handle

+ INFO



ref.	∅ (cm)	H (cm)	☞ (cm)	⊙ (cm)	📦	Bar Code
497518	18	4	12,80	±2	6	8411922475234
497520	20	4,50	14,70	±2	6	8411922475241
497522	22	4,80	16,20	±2	6	8411922475258
497524	24	5	17,70	±2	6	8411922475265
497526	26	5,20	19,20	±2	6	8411922475272
497528	28	5,50	20,70	±2	6	8411922475289
497530	30	5,80	21,50	±2	6	8411922475296

Inducta.

ALUMINIO
ALUMINIUM
ALUMINIUM
ALUMINIUM
ALUMÍNIO



Sartén

Frying Pan
Poêle
Bratpfanne
Frigideira



- Mango de Baquelita
- Bakelite Handle

ref.	∅ (cm)	H (cm)	☞ (cm)	⊙ (cm)	📦	Bar Code
410016	16	4	10	±2	6	8411922078381
410018	18	4,50	12	±2	6	8411922078398
410020	20	4,50	12	±2	6	8411922078404
410022	22	5	15	±2	6	8411922078411
410024	24	5	16	±2	6	8411922078428
410026	26	5,50	17	±2	6	8411922078435
410028	28	6	19	±2	6	8411922078442
410030	30	6	19	±2	6	8411922078459

Sartén Honda con Asas

Deep Frying Pan with Handles
Poêle Profonde avec Anses
Tiefe Bratpfanne mit Griffe
Frigideira Funda com Asas



ref.	∅ (cm)	H (cm)	☞ (cm)	⊙ (cm)	📦	Bar Code
410524	24	7,70	14,50	±2	6	8411922080469
410528	28	8,10	17,50	±2	6	8411922080476
410532	32	8,40	19	±2	6	8411922080483
410536	36	10	19	±2	6	8411922080490
410540	40	11,50	-	-	4	8411922081725

Grill

Grill
Grill
Grillpfanne
Grelhador



ref.	W (cm)	H (cm)	☞ (cm)	⊙ (cm)	📦	Bar Code
410326	26	4,30	17	±2	6	8411922080414

➤ NO INDUCCIÓN

Sartén Honda con Mango

Deep Frying Pan with Handle
Poêle Profonde avec Manche
Tiefe Bratpfanne mit Stiel
Frigideira Funda com Cabo



ref.	Ø (cm)	H (cm)	☞ (cm)	⊙ (cm)	☐	Bar Code
410420	20	7,20	12	±2	6	8411922081695
410424	24	7,70	14,50	±2	6	8411922080438
410428	28	8,10	17,50	±2	6	8411922080445
410432	32	8,40	19	±2	6	8411922080452

Set 3 Sartenes 18+20+24

Set 3 Frying Pans 18 + +20 + +24
Jeu 3 Poêles 18+20+24
Set 3 Brtpfannen 18+20+24
Jogo 3 Frigideiras 18+20+24



ref.	Ø (cm)	☐	Bar Code
410700	18+20+24	4	8411922080964

Freidora con Cestillo

Fryer with Basket
Poêle à Frirer avec Panier
Fritierpfanne mit Korb
Fritadeira com Cesto



ref.	Ø (cm)	H (cm)	☞ (cm)	⊙ (cm)	☐	Bar Code
410618	18	7	10,20	±2	6/12	8411922082715
410624	24	7,60	13,30	±2	6	8411922081435
410626	26	7,80	14,80	±2	6	8411922080506

Sartén para Tamagoyaki

Tamagoyaki Frying Pan
Poêle Tamagoyaki
Tamagoyaki Pfanne
Frigideira para Tamagoyaki



ref.	L (cm)	W (cm)	H (cm)	☞ (cm)	⊙ (cm)	☐	Bar Code
411218	15	18	3,50	14	±2	6/12	8411922082951

Crepiera

Pancake Pan
Poêle à Crêpes
Crêpe Pfanne
Crepeira



ref.	Ø (cm)	H (cm)	☞ (cm)	⊙ (cm)	☐	Bar Code
411326	26	2	17	±2	6	8411922083804
411328	28	2	21	±2	6	8411922083811

Espátula para Tamagoyaki

Spatula Tamagoyaki
Spatule Tamagoyaki
Spatel für Tamagoyaki
Espátula para Tamagoyaki



ref.	L (cm)	W (cm)	☐	Bar Code
738770	25	12	6/108	8411922454383

Sartén

Frying Pan
Poêle
Bratpfanne
Frigideira



- Mango de Baquelita
- Bakelite Handle

ref.	∅ (cm)	H (cm)	☪ (cm)	⊗ (cm)	📦	Bar Code
405016	16	3,50	10	±2	6	8411922077780
405018	18	3,70	12	±2	6	8411922071481
405020	20	4	12	±2	6	8411922071498
405022	22	4,20	15	±2	6	8411922071511
405024	24	4,50	16	±2	6	8411922071528
405026	26	4,70	17	±2	6	8411922071535
405028	28	5	19	±2	6	8411922071542
405030	30	5,20	19	±2	6	8411922071559

Sartén Mini

Mini Frying Pan
Mini Poêle
Mini Bratpfanne
Mini Frigideira



Sartén Mini Color

Mini Frying Pan Color
Mini Poêles Color
Mini Bratpfanne Farbe
Mini Frigideira Color



X4

ref.	∅ (cm)	H (cm)	☪ (cm)	⊗ (cm)	📦	Bar Code
405014	14	3,40	8	±2	12/24	8411922077773

ref.	∅ (cm)	H (cm)	☪ (cm)	⊗ (cm)	📦	Bar Code
405014C	14	3,40	8	±2	12/24	8411922080421

Grill

Grill
Grill
Grillpfanne
Grelhador



Wok Mini

Wok Mini
Wok Mini
Wok Mini
Wok Mini



ref.	L (cm)	W (cm)	H (cm)	📦	Bar Code
405218	18	18	3	6/12	8411922076790
405226	26	26	4	6	8411922075151

ref.	∅ (cm)	H (cm)	☪ (cm)	⊗ (cm)	📦	Bar Code
406116	16	5,80	8,50	±2	6/12	8411922081176

Wok

Wok
Wok
Wok
Wok



ref. Ø (cm) H (cm) ☹ (cm) ☹ (cm) ☹ (cm) ☹ (cm) ☹ (cm) Bar Code

406130 30 8 15 ±2 6 8411922081466

Sartén para Pescado

Fish Frying Pan
Poêle à Poisson
Fischpfanne
Frigideira de Peixe



ref. L (cm) W (cm) H (cm) ☹ (cm) ☹ (cm) ☹ (cm) ☹ (cm) Bar Code

406035 35 24 4,50 20-14 ±2 6 8411922080391

Freidora con Cestillo

Fryer with Basket
Poêle à Frir avec Panier
Fritierpfanne mit Korb
Fritadeira com Cesto



ref. Ø (cm) H (cm) ☹ (cm) ☹ (cm) ☹ (cm) ☹ (cm) ☹ (cm) Bar Code

405726 26 6,80 14,80 ±2 6 8411922078688

Set Sartén 18+22+26

Set Frying Pan 18+22+26
Jeu Poêle 18+22+26
Set Bratpfanne 18+22+26
Jogo Frigideira 18+22+26



ref. Ø (cm) H (cm) ☹ (cm) ☹ (cm) ☹ (cm) Bar Code

405100 18-22-26 3,7-4,2-4,7 6 8411922075144

Sartén para Tortillas

Omelette Pan
Poêle à Tortilla
Tortilla Pfanne
Frigideira para Tortilhas



ref. Ø (cm) H (cm) ☹ (cm) ☹ (cm) ☹ (cm) ☹ (cm) ☹ (cm) Bar Code

405914 14 6,50 10,10 ±2 6/12 8411922080797
405920 20 8 12 ±2 4 8411922080957
405924 24 9 16 ±2 4 8411922079241
405926 26 9,50 17 ±2 4 8411922435238
405928 28 10 19,10 ±2 4 8411922084764

Crepiera

Pancake Pan
Poêle à Crêpes
Crêpe Pfanne
Crepeira



ref. Ø (cm) H (cm) ☹ (cm) ☹ (cm) ☹ (cm) ☹ (cm) ☹ (cm) Bar Code

405820 20 1,70 14,80 ±2 6 8411922092653
405823 23 2 16,40 ±2 6 8411922083729
405826 26 2 19,50 ±2 6 8411922078695
405828 28 2 21,10 ±2 6 8411922080407

Crepiera 4 Cavidades

4 Mini Pancake / Eggs Pan
Poêle à 4 Mini Crêpes / Oeuf
4 Mini Pancake / Eier Pfanne
Crepeira de 4 Mini Crepes / Ovos



ref. Ø (cm) ☹ (cm) H (cm) ☹ (cm) ☹ (cm) Bar Code

406604 26 9 3,50 6 8411922448801

Chef Style.

ALUMINIO FORJADO
FORGED ALUMINUM
ALUMINIUM FORGÉ
GESCHMIEDETES ALUMINIUM
ALUMÍNIO FORJADO



Set 3 Sartenes 18+22+26

Set 3 Frying Pans 18+22+26
Lot 3 Poêles 18+22+26
Set 3 Bratpfannen 18+22+26
Jogo 3 Frigideiras 18+22+26



- **Mango de Baquelita**
- Bakelite Handle

ref.	∅ (cm)	∩ (cm)	@ (cm)	∩	Bar Code
407210	18+22+26	12+15+17	±2	1/4	8411922435603

Venus.

ALUMINIO
ALUMINIUM
ALUMINIUM
ALUMINIUM
ALUMÍNIO



Sartén para Tortillas

Omelette Pan
Poêle à Tortilla
Tortilla Pfanne
Frigideira para Tortilhas



- **Mango de Baquelita**
- **Mango Desmontable**
- Bakelite Handle
- Detachable Handle

ref.	∅ (cm)	H (cm)	∩	Bar Code
300620	20	10	4/16	8411922206869
300624	24	10	4/16	8411922206876

Artika.

ALUMINIO
ALUMINIUM
ALUMINIUM
ALUMINIUM
ALUMÍNIO



Sartén

Frying Pan
Poêle
Bratpfanne
Frigideira



- **Mango de Baquelita**
- Bakelite Handle

ref.	∅ (cm)	∩	Bar Code
321118	18	12	8411922086751
321120	20	12	8411922086768
321122	22	12	8411922086775
321124	24	12	8411922086782
321126	26	12	8411922086799
321128	28	12	8411922086805
321130	30	12	8411922086812

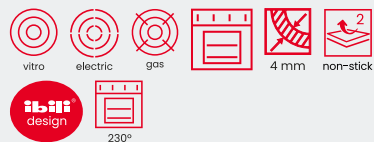

Sartén 12cm

Frying Pan 12cm
Poêle 12cm
Pfanne 12cm
Frigideira 12cm



Sartén 14cm

Frying Pan 14cm
Poêle 14cm
Pfanne 14cm
Frigideira 14cm



induction

ref.	Ø (cm)	H (cm)	📦	Bar Code
404512	12	2,20	12/24	8411922085082

ref.	Ø (cm)	H (cm)	📏 (cm)	🌀 (cm)	📦	Bar Code
404514	14	2,80	10	±2	12/24	8411922091618

Korinto.

ACERO ESMALTADO VITRIFICADO
VITRIFIED ENAMELED STEEL
ACIER ÉMAILLÉ VITRIFIÉ
KERAMISCH EMAILLIERTER STAHL
AÇO ESMALTADO VITRIFICADO



Freidora con Cestillo y Tapa

Fryer with Basket and Lid
Friteuse avec Panier et Couvercle
Frittierpf mit Korb und Deckel
Fritadeira com Cesto e Tampa

- Asas Metálicas
- Tapa de Borosilicato
- Recubrimiento Antiadherente
- Metallic Handles
- Borosilicate lid
- Non-Stick Coating



ref.	Ø (cm)	H (cm)	Lts	📦	Bar Code
961224T	24	12,50	4,60	1/4	8411922096293

Volcán.

ACERO ESMALTADO VITRIFICADO
VITRIFIED ENAMELED STEEL
ACIER ÉMAILLÉ VITRIFIÉ
KERAMISCH EMAILLIERTER STAHL
AÇO ESMALTADO VITRIFICADO



Freidora con Cestillo

Fryer with Basket
Friteuse avec Panier
Frittierpf mit Korb
Fritadeira com Cesto



Freidora con Cestillo y Tapa

Fryer with Basket and Lid
Friteuse avec Panier et Couvercle
Frittierpf mit Korb und Deckel
Fritadeira com Cesto e Tampa



ref.	Ø (cm)	H (cm)	Lts	📦	Bar Code
931624	24	12,50	4,60	4	8411922031249

ref.	Ø (cm)	H (cm)	Lts	📦	Bar Code
931624T	24	12,50	4,60	1/4	8411922042245

Wok

Wok
 Wok
 Wok
 Wok



Sartén para Castañas

Chestnut Frying Pan
 Poêle à Châtaignes
 Kastanien Pfanne
 Frigideira de Castanhas



- Recubrimiento Antiadherente
- Non-Stick Coating

ref.	Ø (cm)	H (cm)	📦	Bar Code
450530	30	8	6	8411922083156

ref.	Ø (cm)	H (cm)	📦	Bar Code
450726	26	3,50	6	8411922089097

Sartenes Formas Moka

Shaped Frying Pans
 Poêles en Forme
 Formen Pfannen
 Frigideiras de Formas



OSITO



BUHO



VACA



PAYASO



MONO



COCHE



CORAZÓN



SONRISA



ref.	L (cm)	W (cm)	H (cm)	📦	Bar Code
450405	12	12	2	6/36	8411922455885
450406	15	11	2	6/48	8411922455892
450400	12	12	1,50	6/48	8411922080834
450401	15	15	1,50	6/72	8411922080841
450402	16	16	1,50	6/48	8411922080858
450403	18	15	1,50	6/24	8411922447521
450404	16,50	15	1,50	6/24	8411922447538
450407	16	16	2	6/24	8411922455908

COCHE / CAR
 BUHO / OWL
 CORAZÓN / HEART
 SONRISA / SMILE
 OSITO / BEAR
 PAYASO / CLOWN
 VACA / COW
 MONO / MONKEY

MiniAlu.

ALUMINIO

ALUMINIUM
ALUMINIUM
ALUMINIUM
ALUMÍNIO

- Mango de Baquelita
- Soft Touch
- Ahorro en energía y aceite
- Bakelite Handle
- Soft Touch
- Save oil and energy



Xylan® Plus
Reliable long-life non-stick coating



Sartén MiniAlu

MiniAlu Frying Pan
Poêle MiniAlu
Bratpfanne Minialu
Frigideira MiniAlu



ANANAS



BLUEBERRY



AVOCADO



PITAYA



FIGUE



CHERRY

ref.	∅ (cm)	H (cm)	☞ (cm)	⊕ (cm)	📦	Bar Code
▶ 404000	14	3	11,40	±2	12	8411922470697
404014A	14	3	11,40	±2	6	8411922457735
404014B	14	3	11,40	±2	6	8411922457742
404014C	14	3	11,40	±2	6	8411922457759
404014D	14	3	11,40	±2	6	8411922457766
404014E	14	3	11,40	±2	6	8411922457773
404014F	14	3	11,40	±2	6	8411922457780

SURTIDO
BLUEBERRY
AVOCADO
ANANAS
FIGUE
CHERRY
PITAYA

Expositor Columna para Sartenes Mini

Column Display for Mini Frying Pans
Exposant Colonne Mini Poêle
Ständer für Mini-Bratpfannen
Expositor de Coluna para Mini Frigideiras

ref.	H (cm)	📦	Bar Code
000970	160	1	8411922454895



Colorful.

ACERO ESMALTADO VITRIFICADO

VITRIFIED ENAMELED STEEL

ACIER ÉMAILLÉ VITRIFIÉ

KERAMISCH EMAILLIERTER STAHL

AÇO ESMALTADO VITRIFICADO

- Mango de Baquelita
- Ahorro en energía y aceite
- Bakelite Handle
- Save oil and energy



Sartén Mini Colorful

Mini Colorful Frying Pan

Poêle Mini Colorful

Bratpfanne Mini Colorful

Frigideira Mini Colorful



CIEL



MUSGO



GRISE



PECHE



CITRON



PETROL



ref.	∅ (cm)	H (cm)	☞ (cm)	⊙ (cm)	∞	Bar Code	
930014A	14	4,50	11,50	±2	6	8411922455038	PETROL
930014D	14	4,50	11,50	±2	6	8411922455069	GRISE
930014B	14	4,50	11,50	±2	6	8411922455045	CITRON
930014E	14	4,50	11,50	±2	6	8411922455076	MUSGO
930014C	14	4,50	11,50	±2	6	8411922455052	PECHE
930014F	14	4,50	11,50	±2	6	8411922455083	CIEL

New Orange.

ACERO ESMALTADO VITRIFICADO
VITRIFIED ENAMELED STEEL
ACIER ÉMAILLE VITRIFIÉ
KERAMISCH EMAILLIERTER STAHL
AÇO ESMALTADO VITRIFICADO



Sartén

Frying Pan
Poêle
Bratpfanne
Frigideira



- **Mango de Baquelita**
- Bakelite Handle

ref.	∅ (cm)	H (cm)	∩	Bar Code
916318	18	4,20	6	8411922207798
916320	20	4,30	6	8411922207804
916322	22	4,30	6	8411922207811
916324	24	4,60	6	8411922207828
916326	26	4,70	6	8411922207835
916328	28	4,90	6	8411922207842

Sartén Honda con Mango

Deep Frying Pan with Handle
Poêle Profonde avec Manche
Tief Bratpfanne mit Stiel
Frigideira Funda com Cabo



ref.	∅ (cm)	H (cm)	∩	Bar Code
916526	26	8,40	6	8411922209075
916528	28	8,90	6	8411922209082
▶ 916530	30	9	4	8411922161465
▶ 916532	32	9	4	8411922161960

Sartén Honda con Asas

Deep Frying Pan with Handles
Poêle Profonde avec Anses
Tief Bratpfanne mit Griffe
Frigideira Funda com Asas



- **Asas Metálicas**
- Metallic Handles



ref.	∅ (cm)	H (cm)	Lts	∩	Bar Code
916728	28	8,30	3	6	8411922161458
916732	32	9,50	5	4	8411922161953
916736	36	11	8	4	8411922068757
916740	40	11	11	4	8411922068764



Accesorios.

Cestillo para Cazo

Sauce Pan Basket
Panier pour Casserole
Korb für Stielkasserolle
Cesto para Caçarola



- Acero Inoxidable
- Stainless Steel



ref.	∅ (cm)	H (cm)	📦	Bar Code
751918	18	8	6	8411922205732

Cestillo Freidor de Rejilla Inox

Stainless Steel Mesh Frying Basket
Panier Friteuse avec Grille en Inox
Frittierkorb aus Edelstahl
Cesto para Fritar de Rede Inox



- Acero Inoxidable 18%
- Stainless Steel 18%

ref.	∅ (cm)	H (cm)	📦	Bar Code
730818	16,50	6	6	8411922448269
730824	22,50	7	6	8411922448276
730826	24,50	7	6	8411922448283
730828	26,50	7	6	8411922448290

Cestillo Freidor Estañado 2 Asas

Tin Plated Frying Basket 2 Handles
Panier Friteuse Étamé 2 Anses
Verzinnter Frittierkorb 2 Griffe
Cesto para Fritar 2 Cabos



- Acero Estañado
- Stainless Steel

ref.	∅ (cm)	📦	Bar Code
751823	23	4	8411922202113

Tostador de Pan

Bread Toaster
Grille-Pain
Brot-Toaster
Torradeira de Pão



- Acero Estañado
- Stainless Steel



ref.	L (cm)	W (cm)	📦	Bar Code
810400	20	20	6/60	8411922600087

Set 3 Protectores de Sartenes

Set 3 Frying Pan Protectors
Jeu 3 Protecteurs de Poêles
Set 3 Pfannenschützer
Jogo 3 Protetores de Frigideiras

- Fieltro
- Fieltro



ref.	∅ (cm)	📦	Bar Code
782650	35-40-45	6/48	8411922437683

Churrasquera

Gas-Grill
Grill-Gaz
Grill-Gas
Grill-Gas



- Acero Esmaltado
- Acero Inoxidable
- Mango Desmontable
- Enameled Steel
- Stainless Steel
- Detachable Handle



ref.	∅ (cm)	H (cm)	∅	Bar Code
980032	32	9	1/6	8411922447934

Soporte Inox para Plato de Hierro

Stainless Steel Iron Dish Holder
Support Inox pour Plaque de Fer
Edelstahlhalterung für Gusseisen Teller
Suporte para Prato de Ferro



- Acero Inoxidable 18/10
- Asas de Acero Inoxidable
- Stainless Steel 18/10
- Stainless Steel Handles



ref.	∅ (cm)	∅ (cm)	H (cm)	∅	Bar Code
700900	33	26	14	1/12	8411922453119
700950	37,50	30	14	1/6	8411922456448

Plato de Hierro Fundido + Base de Madera

Cast Iron Plate + Wooden Base
Plat en Fonte de Fer + Base en Bois
Gusseisenplatte + Holzuntersatz
Prato de Ferro Fundido + Base de Madeira



- Madera de Haya
- Con Pinza
- Beech Wood
- With Clamp



ref.	L (cm)	∅ (cm)	H (cm)	∅	Bar Code
627026	34	26	3,80	1/4	8411922456431
627030	40	30	4,20	1/4	8411922456684

Plato de Hierro Fundido

Cast Iron Plate
Plat en Fer Forgé
Gusseisenplatte
Prato de Ferro Fundido



- Con Pinza
- With Clamp



ref.	∅ (cm)	H (cm)	∅	Bar Code
625926	26	2	1/4	8411922452099
625930	30	2	1/4	8411922452105

NEW

Plato de Hierro Fundido Rectangular + Base de Madera

Rectangular Cast Iron Plate + Wooden Base

Plat Rectangulaire en Fonte + Base en Bois

Rechteckiger Gusseisenplatte + Holzuntersatz

Prato Retangular de Ferro Fundido + Base de Madeira

- Hierro Fundido
- Madera de Haya
- Cast Iron
- Beech Wood



induction



vitro



electric



gas



ref.	L (cm)	W (cm)		Bar Code
667734	34	20	1/4	8411922475463
667738	38	28	1/4	8411922475470



Paelleras.



Paella Pans Plats à Paëlla Paellapfannen Paelheiras



<u>Triply</u>	071
<u>Evolution</u>	071
<u>Premier</u>	071
<u>Bistrot</u>	072
<u>Inducta</u>	072
<u>Fusión</u>	072
<u>Nero</u>	073
<u>Gandía</u>	073
<u>Orange</u>	073
<u>Accesorios</u>	074

Triply Energy.

ACERO INOXIDABLE. ALUMINIO
STAINLESS STEEL. ALUMINIUM
ACIER INOXYDABLE. ALUMINIUM
ROSTFREIER STAHL. ALUMINIUM
AÇO INOXIDÁVEL. ALUMÍNIO



Paellera

Paella Pan
Plat à Paella
Paellapfanne
Paelheira



- **Material Tricapa (Inox-Alu-Inox)**
- **Asas de Acero Inoxidable**
- **Three-Ply Material (Inox-Alu-Inox)**
- **Stainless Steel Handles**

3 CAPAS



ref.	∅ (cm)	H (cm)	∅	∅	∅ (cm)	∅ (cm)	Bar Code
652130	30	4,10	4	2/6	23	±2	8411922457148
652134	34	4,40	6	2/6	25	±2	8411922457155
652138	38	4,50	8	2/6	30,50	±2	8411922457162
652142	42	5	10	2/6	31,50	±2	8411922457179

Evolution.

ALUMINIO FUNDIDO
CAST ALUMINUM
FONTE D'ALUMINIUM
ALUMINIUMGUSS
ALUMÍNIO FUNDIDO



Paellera

Paella Pan
Plat à Paella
Paellapfanne
Paelheira



- **Full Induction**
- **Asas Desmontables Silicona**
- **Full Induction**
- **Detachable Handles Silicone**

ref.	∅ (cm)	H (cm)	∅	∅ (cm)	∅ (cm)	∅	Bar Code
461436	36	4,70	6	29,50	±2	1/4	8411922437430

Premier.

ACERO INOXIDABLE
STAINLESS STEEL
ACIER INOXYDABLE
ROSTFREIER STAHL
AÇO INOXIDÁVEL

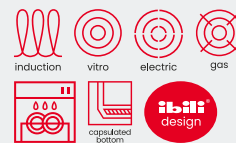

Paellera

Paella Pan
Plat à Paella
Paellapfanne
Paelheira



- **Asas de Acero Inoxidable**
- **Stainless Steel Handles**

ref.	∅ (cm)	H (cm)	∅	∅	∅ (cm)	∅ (cm)	Bar Code
652228	28	4	2	4/12	21,40	±2	8411922075274
652232	32	4	5	4/8	25,40	±2	8411922075281
652234	34	4,50	6	2/8	27,40	±2	8411922075298
652236	36	4,50	7	2/8	29,40	±2	8411922075304
652240	40	5	9	2/6	33,40	±2	8411922075311

Bistrot.

ACERO INOXIDABLE
STAINLESS STEEL
ACIER INOXYDABLE
ROSTFREIER STAHL
AÇO INOXIDÁVEL

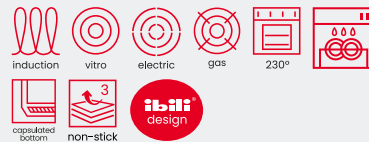

Paellera

Paella Pan
Plat à Paella
Paellapfanne
Paelheira



- Asas de Acero Inoxidable
- Stainless Steel Handles

ref.	∅ (cm)	H (cm)	∅	∅	∅ (cm)	∅ (cm)	Bar Code
652028	28	4	2	4/12	21,40	±2	8411922069518
652032	32	4	5	4/8	25,40	±2	8411922422146
652034	34	4,50	6	2/8	27,40	±2	8411922422153
652036	36	4,50	7	2/8	29,40	±2	8411922422160
652040	40	5	9	2/6	33,40	±2	8411922068849

Inducta.

ALUMINIO
ALUMINIUM
ALUMINIUM
ALUMINIUM
ALUMÍNIO



Paellera

Paella Pan
Plat à Paella
Paellapfanne
Paelheira



- Asas Metálicas
- Metallic Handles

ref.	∅ (cm)	H (cm)	∅	∅	∅ (cm)	∅ (cm)	Bar Code
410226	26	4,10	2	4/16	16,50	±2	8411922078466
410230	30	4,10	4	4/16	18	±2	8411922078473
410234	34	4,40	6	4/12	20,60	±2	8411922078480
410238	38	4,50	8	2/8	26	±2	8411922078497
410242	42	5	10	2/8	26	±2	8411922078893

Fusión.

ALUMINIO
ALUMINIUM
ALUMINIUM
ALUMINIUM
ALUMÍNIO

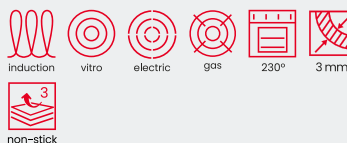

Paellera

Paella Pan
Plat à Paella
Paellapfanne
Paelheira



- Asas Metálicas
- Metallic Handles

ref.	∅ (cm)	H (cm)	∅	∅	∅ (cm)	∅ (cm)	Bar Code
451126	26	4,20	2	4	16,50	±2	8411922450026
451130	30	4,20	4	4	18	±2	8411922450033
451134	34	4,20	6	4	20,60	±2	8411922450040
451138	38	4,20	8	4	26	±2	8411922450057
451142	42	4,20	10	4	26	±2	8411922450064

Nero.

ALUMINIO
ALUMINIUM
ALUMINIUM
ALUMINIUM
ALUMÍNIO



Paellera

Paella Pan
Plat à Paella
Paellapfanne
Paelheira



- Asas Metálicas
- Metallic Handles

ref.	Ø (cm)	H (cm)	Personas	Capacidad (l)	Bar Code
380030	30	4,20	4	4/16	8411922070705
380034	34	4,40	6	4/12	8411922070712
380038	38	4,50	8	4/8	8411922070729
380042	42	5,10	10	4/8	8411922070736
380046	46	5,20	12	4/8	8411922070743
380050	50	5,20	14	4	8411922070750

Gandía.

ACERO CON ANTIADHERENTE
STEEL WITH NON-STICK COATING
ACIER AVEC REVÊTEMENT ANTIADHÉSIF
STAHL MIT ANTIHAFTBESCHICHTUNG
AÇO COM REVESTIMENTO ANTIADERENTE



Paellera

Paella Pan
Plat à Paella
Paellapfanne
Paelheira



- Asas Metálicas
- Metallic Handles

ref.	Ø (cm)	H (cm)	Personas	Capacidad (l)	Bar Code
501028	28	4	2	4/12	8411922434347
501032	32	4,50	5	4/12	8411922434354
501036	36	4,50	7	4/8	8411922434361
501040	40	5	9	4/8	8411922434378
501046	46	5	12	4	8411922434385

Orange.

ACERO ESMALTADO VITRIFICADO
VITRIFIED ENAMELED STEEL
ACIER ÉMAILLÉ VITRIFIÉ
KERAMISCH EMAILLIERTER STAHL
AÇO ESMALTADO VITRIFICADO



Paellera

Paella Pan
Plat à Paella
Paellapfanne
Paelheira



- Asas Metálicas
- Metallic Handles

ref.	Ø (cm)	H (cm)	Personas	Capacidad (l)	Bar Code
917130	30	5,30	4	6	8411922068665
917134	34	5,40	6	6	8411922068672
917138	38	6	8	6	8411922068689

Accesorios.

Asas Protectoras para Paellera

Paella Pan Handle Covers
Anses de Protection pour les Plats à Paella
Griffschutz für Paella Pfanne
Asas Protetoras para Paelheira



- **Silicona**
- **Universal**
- Silicone
- Universal



230°



ref.	∅ (cm)		Bar Code
627100	9,50	6	8411922456691

Expositor Paelleras

Paella Pan Stand
Présentoir Plat à Paella
Ständer für Paellapfanne
Expositor de Paelleras



- **Acero**
- **Regulable**
- Steel
- Adjustable

ref.		H (cm)	Bar Code
000906	1	175	8411922435023



Repostería.



Bakeware

Patisserie

Konditoreiwaren

Pastelaria

<u>Class</u>	077	<u>Helados</u>	121
<u>Golden Class</u>	077	<u>Moldes Varios</u>	123
<u>Blu</u>	079	<u>Sopletes</u>	128
<u>Venus</u>	080	<u>Aros para Emplatar</u>	130
<u>Strawberry</u>	082	<u>Sifones y Cargas</u>	133
<u>Blueberry</u>	084	<u>Churreras</u>	135
<u>Crous</u>	086	<u>Rosquilleras</u>	136
<u>Moka</u>	088	<u>Cortapastas</u>	136
<u>Mini Moka</u>	097	<u>Cortadores y Marcadores</u>	148
<u>Clásica</u>	098	<u>Mangas y Boquillas</u>	153
<u>Aluminio</u>	101	<u>Decoración</u>	160
<u>Acero Estañado</u>	101	<u>Soportes</u>	162
<u>Moldes Desechables</u>	102	<u>Básculas</u>	164
<u>Ceramic</u>	103	<u>Velas</u>	164
<u>Banneton</u>	104	<u>Utensilios</u>	166
<u>Kristall</u>	104	<u>Tamizadores</u>	173
<u>Freidora de Aire / Horno</u>	106	<u>Medidores</u>	174
<u>Rustideras</u>	107	<u>Cápsulas</u>	176
<u>Chocolate</u>	110	<u>Bandejas y Blondas</u>	180
<u>Turrón</u>	118	<u>Fondant</u>	182
		<u>Anodized Aluminium</u>	188
		<u>Antiadherentes</u>	189

Class.

ALUMINIO FUNDIDO

CAST ALUMINUM
FONTE D'ALUMINIUM
ALUMINIUMGUSS
ALUMÍNIO FUNDIDO

- Recubrimiento Antiadherente
- Non-Stick Coating



non-stick



Molde Corazón

Heart-Shaped Mould
Moule Cœur
Herzform
Molde Coração



ref.	L (cm)	W (cm)	H (cm)		Bar Code
889000	27,50	27	6,10	1/6	8411922470819

Molde 9 Cavidades Navidad

9 Cavity Christmas Mould
Moule 9 Cavités Noël
Form mit 9 Vertiefungen, Weihnachten,
Molde 9 cavidades Natal



ref.	L (cm)	W (cm)	H (cm)		Bar Code
889010	27,50	24,50	4,20	1/6	8411922470826

Golden Class.

ACERO CON ANTIADHERENTE
STEEL WITH NON-STICK COATING
ACIER AVEC REVÊTEMENT ANTIADHÉSIF
STAHL MIT ANTIHAFTBESCHICHTUNG
AÇO COM REVESTIMENTO ANTIADERENTE



Eclipse™

Hard reinforced non-stick coating



hanger

Molde Cake

Cake Mold
Moule Cake
Kastenform
Forma Bolo Inglês



ref.	L (cm)	W (cm)	H (cm)		Bar Code
840230	30	11	6,70	6/12	8411922435733

Molde Desmontable con Base Extra

Springform Mold with
Extra Base
Moule Démontable avec
Base Extra
Springform mit Extra Boden
Forma Desmontável com Base Extra



ref.	∅ (cm)	H (cm)		Bar Code
840026	26	7	6	8411922435719

Bandeja para Galletas

Biscuit Tray
Plaque à Biscuits
Tablett für Kekse
Tabuleiro para Bolachas



ref.	L (cm)	W (cm)	H (cm)		Bar Code
841041	41	32	1,60	6/12	8411922435801

Rustidera

Roast Pan
Plat à Rôtir
Bratreine
Tabuleiro



ref.	L (cm)	W (cm)	H (cm)		Bar Code
840935	35	25	6,40	6/12	8411922435795

Molde Cuadrado

Square Mold
Moule Carré
Quadratische Backform
Forma Quadrada



ref.	L (cm)	W (cm)	H (cm)		Bar Code
840324	24	24	5	6/12	8411922435740

Molde Savarín

Savarin Mold
Moule Savarin
Savarinform
Forma Savarin



ref.	∅ (cm)	H (cm)		Bar Code
840826	26	6	6/12	8411922435788

Molde Rizado

Fluted Mold
Moule Dentelé
Geriffelte Backform
Forma Canelada



ref.	∅ (cm)	H (cm)		Bar Code
840728	28	3	6/12	8411922435771

Molde Alto

High Mold
Moule Haut
Hohe Backform
Forma Alta



ref.	∅ (cm)	H (cm)		Bar Code
840126	26	5,50	6/12	8411922435726

Molde Pizza

Pizza Mold
Moule Pizza
Pizaform
Forma para Pizza



ref.	∅ (cm)	H (cm)		Bar Code
840634	34	2,50	6/12	8411922435764

Molde Muffin 12 Cavidades

Muffin Pan 12 Cups
Moule à Muffins 12 Cavités
Muffinform 12 Kavitäten
Forma Muffin 12 Cavidades



ref.	L (cm)	W (cm)	H (cm)	∅ (cm)		Bar Code
840500	38	29	3	6,50	6/12	8411922435757



Molde Cake

Cake Mold
Moule Cake
Kastenform
Forma de Bolo Inglês



ref.	L (cm)	W (cm)	H (cm)	Lts	☐	Bar Code
331025	25	11	7	1,50	6	8411922160383
331030	30	11	7	2,20	6	8411922160390

Molde Desmontable

Springform Mold
Moule Démontable
Springform
Forma desmontável



ref.	∅ (cm)	H (cm)	☐	Bar Code
331524	24	6,50	6	8411922160529
331526	26	6,50	6	8411922160536
331528	28	6,50	6	8411922160543

Molde Savarin

Savarin Mold
Moule Savarin
Backform Savarin
Forma Savarin



ref.	∅ (cm)	H (cm)	Lts	☐	Bar Code
330926	26	5,90	2	6	8411922160369

Molde Pizza Crispy

Crispy Pizza Mold
Moule Pizza Crispy
Pizzaform Crispy
Forma de Pizza Crispy



ref.	∅ (cm)	H (cm)	☐	Bar Code
331228	28	1,80	6	8411922160444
331232	32	2	6	8411922160451

Flanero Individual

Individual Creme Caramel Mold
Moule à Crème Caramel Individuel
Einzel Puddingform
Forma Individual para Pudim Flan



ref.	∅ (cm)	H (cm)	Lts	☐	Bar Code
330408	8	5,50	0,18	12	8411922160222

Flanero con Tapa Inox

Creme Caramel Mold with Lid
Moule Crème Caramel avec Couvercle
Puddingform mit Deckel
Forma Pudim Flan com Tampa



ref.	∅ (cm)	H (cm)	Lts	☐	Bar Code
331118	18	10,30	2	6	8411922160420

Molde Alto

Pie Mold
Moule Haut
Hohe Backform
Forma de Bolo Alta



ref.	Ø (cm)	H (cm)	Lts	📦	Bar Code
355422	22	4,80	1,20	6	8411922211221
355426	26	5,50	2,50	6	8411922211269
355430	30	5,50	3	6	8411922211306

Molde Savarín

Savarin Mold
Moule Savarin
Backform Savarin
Forma Savarin



ref.	Ø (cm)	H (cm)	Lts	📦	Bar Code
355824	24	5,50	1,70	6	8411922215243
355826	26	5,90	2	6	8411922215267
355828	28	6	2,50	6	8411922077933

Molde Bajo

Tart Mold
Moule Bas
Tarteform
Forma de Bolo Baixa



ref.	Ø (cm)	H (cm)	Lts	📦	Bar Code
355527	27	3,90	2	6	8411922212273

Molde Rizado

Fluted Tart Mold
Moule à Tarte Dentelé
Tarteform
Forma de Tarte
Canelada



ref.	Ø (cm)	H (cm)	Lts	📦	Bar Code
355728	28	3	2	6	8411922214284
355732	32	3,20	2,50	6	8411922214321

Molde Cake

Cake Mold
Moule Cake
Kastenform
Forma de Bolo Inglês



ref.	L (cm)	W (cm)	H (cm)	Lts	📦	Bar Code
355925	25	11	7	1,50	6	8411922216257
355930	30	11	7	2,20	6	8411922216301
355935	35	11	7	3	6	8411922077926

Flanero Rizado

Brioche Mold
Moule à Brioche
Briocheform
Forma de Pudim Flan
Canelada



ref.	Ø (cm)	H (cm)	Lts	📦	Bar Code
355210	10	4,20	0,15	12	8411922209105
355218	18	6	0,70	12	8411922209181
355222	22	6	1,50	6	8411922209228



Molde Desmontable 2 Usos

Springform Mold with Tube
Moule Démontable 2 usages
Springform mit Rohrboden
Forma Desmontável 2 Usos



ref.	Ø (cm)	H (cm)	📦	Bar Code
356626	26	6,50	5	8411922802030

Molde Desmontable

Springform Mold
Moule Démontable
Springform
Forma Desmontável



ref.	Ø (cm)	H (cm)	📦	Bar Code
356524	24	6,50	6	8411922802009
356526	26	6,50	6	8411922802016
356528	28	6,50	6	8411922802023

Molde Rizado Móvil

Loose Bottom Tart Mold
Moule à Tarte Dentelé Amovible
Tarteform mit Heheboden
Forma de Tarte Canelada Móvel



ref.	Ø (cm)	H (cm)	Lts	📦	Bar Code
356224	24	3	1,50	6	8411922236248
356228	28	3	2	6	8411922236286
356232	32	3,20	2,50	6	8411922236323

Molde Pizza

Pizza Mold
Moule Pizza
Pizzaform
Forma de Pizza



ref.	Ø (cm)	H (cm)	📦	Bar Code
356928	28	1,80	6	8411922207897
356932	32	2	6	8411922207903

Molde Pizza Crispy

Crispy Pizza Mold
Moule Pizza Crispy
Pizzaform Crispy
Forma de Pizza Crispy



ref.	Ø (cm)	H (cm)	📦	Bar Code
356124	24	1,80	6	8411922226249
356128	28	1,80	6	8411922226287
356132	32	2	6	8411922226324

Flanero Individual

Individual Creme Caramel Mold
Moule à Crème Caramel Individuel
Einzel Puddingform
Forma Individual para Pudim Flan



ref.	Ø (cm)	H (cm)	Lts	📦	Bar Code
355308	8	5,50	0,18	12	8411922210088

Flanero con Tapa Inox

Crème Caramel Mold with Lid
Moule Crème Caramel avec
Couvercle
Puddingform mit Deckel
Forma Pudim Flan com Tampa



ref.	Ø (cm)	H (cm)	Lts	📦	Bar Code
356016	16	9,40	1,20	6	8411922219166
356018	18	10,30	2	6	8411922219180
356020	20	11,40	2,80	6	8411922068603



Strawberry.

SILICONA
SILICONE
SILICONE
SILIKON
SILICONE



Molde Cake

Cake Mold
Moule Cake
Kastenform
Forma Bolo Inglês



ref.	L (cm)	W (cm)	H (cm)	📦	Bar Code
875125	25	10,50	6,50	6/24	8411922443080
875130	30	10,50	6,50	6/24	8411922443097

Molde Alto

High Mold
Moule Haut
Hohe Backform
Forma Alta



ref.	∅ (cm)	H (cm)	📦	Bar Code
875520	20	5,50	6/24	8411922444032
875526	26	5,50	6/24	8411922444049

Molde Rizado

Fluted Mold
Moule Dentelé
Geriffelte Backform
Forma Canelada



ref.	∅ (cm)	H (cm)	📦	Bar Code
875228	28	3	6/24	8411922444001

Molde Savarin

Savarin Mold
Moule Savarin
Savarinform
Forma Savarin



ref.	∅ (cm)	H (cm)	📦	Bar Code
875424	24	5,50	6/24	8411922444025

Flanero Rizado

Brioche Mold
Moule à Brioche
Briocheform
Forma de Pudim Flan Canelada



ref.	∅ (cm)	H (cm)	📦	Bar Code
875322	22	8	6/24	8411922444018

Flanero Individual (2 uds.)

Individual Creme Caramel Mold
Moule à Crème Caramel Individuel
Einzel Puddingform
Forma Individual para Pudim Flan



ref.	∅ (cm)	Lts	📦	Bar Code
875001	8	0,18	12/72	8411922443073

Molde Muffin 6 Cavidades

Muffin Pan 6 Cups
Moule à Muffins 6 Cavités
Muffinform 6 Kavitäten
Forma Muffin 6 Cavidades

ref.	∅ (cm)	H (cm)	📦	Bar Code
875600	7,90	3,70	6/24	8411922444056



Molde Doughnut 7 Cavidades

Doughnut Mold 7 Cavities
 Moule Doughnut 7 Cavités
 Doughnut Backform mit 7 Kavitäten
 Forma Doughnut 7 Cavidades



ref.	∅ (cm)	L (mm)	H (cm)		Bar Code
876050	7	26	4,50	1/6/24	8411922458657

Molde Doughnut 6 Cavidades

Doughnut Mold 6 Cavities
 Moule Doughnut 6 Cavités
 Doughnut Backform mit 6 Kavitäten
 Forma Doughnut 6 Cavidades



ref.	∅ (cm)	L (mm)	W (cm)	H (cm)		Bar Code
876000	8	32	22	5	3/6/24	8411922455984

Molde Desmontable Rectangular con Base de Cristal

Rectangular Springform with Glass Bottom
 Moule Amovible Rectangulaire avec Base en Verre
 Rechteckige Springform mit Glasboden
 Forma Retangular Desmontável com Base de Vidro



ref.	L (cm)	W (cm)	H (cm)		Bar Code
875900	25,50	10	7	1/6	8411922455267

Molde Desmontable Redondo con Base de Cristal

Round Springform with Glass Bottom
 Moule Amovible Rond avec Base en Verre
 Runde Springform mit Glasboden
 Forma Redonda Desmontável com Base de Vidro



ref.	∅ (cm)	H (cm)		Bar Code
875700	22,50	7	1/6	8411922455243
875712	12	4,50	1/6/24	8411922459029
875719	19	7	1/6	8411922458435

Molde Desmontable Cuadrado con Base de Cristal

Square Springform with Glass Bottom
 Moule Amovible Carré avec Base en Verre
 Quadratisch Springform mit Glasboden
 Forma Quadrada Desmontável com Base de Vidro



ref.	L (cm)	W (cm)	H (cm)		Bar Code
875800	21,50	21,50	7	1/6	8411922455250

Blueberry.

SILICONA

SILICONE
SILICONE
SILIKON
SILICONE

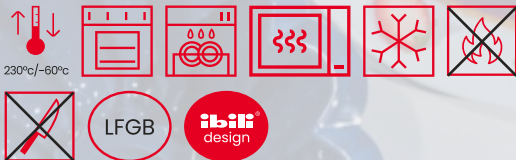

Molde Cake

Cake Mold
Moule Cake
Kastenform
Forma Bolo Inglês



ref.	L (cm)	W (cm)	H (cm)	Lts	📦	Bar Code
870004	25	10	6,50	1,40	6/24	8411922082562
870005	30	10	6,50	2,20	6/24	8411922082579

Flanero Rizado

Brioche Mold
Moule à Brioche
Briocheform
Forma de Pudim Flan
Canelada



ref.	∅ (cm)	H (cm)	Lts	📦	Bar Code
870008	22	8	1,60	6/24	8411922082609

Molde Alto

High Mold
Moule Haut
Hohe Backform
Forma Alta



ref.	∅ (cm)	H (cm)	Lts		Bar Code
870820	20	5,50	-	6/24	8411922086270
870010	26	5,50	2,50	6/24	8411922082623

Molde Rizado

Fluted Mold
Moule Dentelé
Geriffelte Backform
Forma Canelada



ref.	∅ (cm)	H (cm)	Lts		Bar Code
870006	24	3	1,40	6/24	8411922082586
870007	28	3	1,90	6/24	8411922082593

Molde Savarin

Savarin Mold
Moule Savarin
Savarinform
Forma Savarin



ref.	∅ (cm)	H (cm)	Lts		Bar Code
870009	24	5,50	1,70	6/24	8411922082616
870926	26	5,50	-	6/24	8411922086287

Molde Cake Mini (2 uds.)

Mini Cake Mold
Moule Mini Cake
Mini-Kastenform
Forma Bolo Inglês Mini



ref.	L (cm)	W (cm)	H (cm)	Lts		Bar Code
870024	15	6,50	4	0,25	6/24	8411922084122

Flanero Individual (2 uds.)

Individual Creme Caramel Mold
Moule à Crème Caramel
Puddingform
Forma para Pudim Flan



ref.	∅ (cm)	Lts		Bar Code
870001	8	0,18	1/12/72	8411922084139

Tapete para Horno

Oven Mat
Tapis de Four
Backmatte
Tapete para Forno



ref.	L (cm)	W (cm)	H (mm)	Lts		Bar Code
860021	40	30	1,25	6/36	8411922208900	

Molde Cake 12 Cavidades

Cake Mold 12 Cavities
Moule Cake 12 Cavités
Kastenform 12 Kavitäten
Forma Bolo Inglês 12 Cavidades



ref.	L (cm)	W (cm)	H (cm)	Lts		Bar Code
870039	7,90	2,90	3	0,025	6/24	8411922083408

Molde Muffin 6 Cavidades

Muffin Pan 6 Cups
Moule à Muffins 6 Cavités
Muffinform 6 Kavitäten
Forma Muffin 6 Cavidades



ref.	∅ (cm)	H (cm)	Lts		Bar Code
870012	6,50	3,70	6/24	8411922082807	

Molde Semiesfera 6 Cavidades (Ø6cm)

6 Half-Spheres Pan (Ø6cm)
 Moule Semi-Sphère 6 Cavités (Ø6cm)
 Halbkugel Form 6 Kavitäten (Ø6cm)
 Forma Semiesfera 6 Cavidades (Ø6cm)

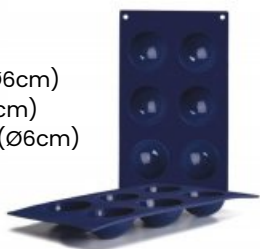

ref.	Ø (cm)	H (cm)		Bar Code
870040	6	3	6/24	8411922434491

Molde Semiesfera 6 Cavidades (Ø7cm)

6 Half-Spheres Pan
 Moule Semi-Sphère 6 Cavités
 Halbkugel Form 6 Kavitäten
 Forma Semiesfera 6 Cavidades



ref.	Ø (cm)	H (cm)		Bar Code
870033	7	3	6/24	8411922083354

Molde Semiesfera 8 Cavidades

8 Half-Spheres Pan
 Moule Semi-Sphère 8 Cavités
 Halbkugel Form 8 Kavitäten
 Forma Semiesfera 8 Cavidades



ref.	Ø (cm)	H (cm)		Bar Code
870041	5	2,50	6/24	8411922434507

Molde Semiesfera 15 Cavidades

15 Half-Spheres Pan
 Moule Semi-Sphère 15 Cavités
 Halbkugel Form 15 Kavitäten
 Forma Semiesfera 15 Cavidades



ref.	Ø (cm)	H (cm)		Bar Code
870042	4	2	6/24	8411922434514

Molde Semiesfera 24 Cavidades

24 Half-Spheres Pan
 Moule Semi-Sphère 24 Cavités
 Halbkugel Form 24 Kavitäten
 Forma Semiesfera 24 Cavidades

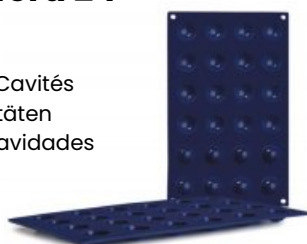

ref.	Ø (cm)	H (cm)		Bar Code
870043	3	1,50	6/24	8411922434521

Molde Bombón 24 Cavidades

Chocolate Pan 24 Cavities
 Moule Praliné 24 Cavités
 Bonbonform 24 Kavitäten
 Forma Bombom 24 Cavidades



ref.	Ø (cm)	H (cm)		Bar Code
870018	3,40	1,60	6/36	8411922083347

Crous.

CHAPA DE ACERO
 STEEL PLATE
 PLAQUE D'ACIER
 STAHLPLATTE
 PLACA DE AÇO



PPG Xylan®

Molde Alto

High Mold
 Moule Haut
 Hohe Backform
 Forma Alta



- **Perforado**
- **Recubrimiento Antiadherente**
- Perforated
- Non-Stick Coating

ref.	Ø (cm)	H (cm)		Bar Code
835424	24	4	6/12	8411922441130

Molde Rizado Móvil

Fluted Loose Bottom Mold
Moule Dentelé Amovible
Geriffelte Abnehmbar Backform
Forma Canelada Fundo Móvel



ref.	Ø (cm)	H (cm)	📦	Bar Code
------	--------	--------	---	----------

835320	20	2,50	6/36	8411922449136
835324	24	2,50	6/24	8411922449143
835328	28	2,60	6/24	8411922441123
835330	30	3	6/24	8411922449150

Molde Muffin 12 Cavidades

Muffin Pan 12 Cups
Moule 12 Muffin
Muffinform 12 Kavitäten
Forma Muffins 12 Cavidades



ref.	L (cm)	W (cm)	H (cm)	📦	Bar Code
------	--------	--------	--------	---	----------

835012	35	6	3	6/12	8411922441079
--------	----	---	---	------	---------------

Molde Cake

Cake Mold
Moule Cake
Kastenform
Forma Bolo Inglês



ref.	L (cm)	W (cm)	H (cm)	📦	Bar Code
------	--------	--------	--------	---	----------

835125	25	11	7	6/36	8411922441086
835130	30	11	7	6/24	8411922441093

Molde Rectangular Móvil

Rectangular Loose Bottom Mold
Moule Rectangulaire Amovible
Rechteckige Abnehmbar Backform
Forma Retangular Fundo Móvel



ref.	L (cm)	W (cm)	H (cm)	📦	Bar Code
------	--------	--------	--------	---	----------

835231	31	21	3	6/18	8411922441109
--------	----	----	---	------	---------------

Molde Rectangular Móvil Alargado

Long Rectangular Loose Bottom Mold
Moule Long Rectangulaire Amovible
Rechteckige Längliche Abnehmbar Backform
Forma Retangular Alongada Fundo Móvel



ref.	L (cm)	W (cm)	H (cm)	📦	Bar Code
------	--------	--------	--------	---	----------

835235	35	11	3	6/18	8411922441116
--------	----	----	---	------	---------------

Bandeja Rectangular

Rectangular Tray
Plateau Rectangulaire
Rechteckiges Tablett
Bandeja Retangular



ref.	L (cm)	W (cm)	H (cm)	📦	Bar Code
------	--------	--------	--------	---	----------

835539	39	7	2	6/12	8411922446999
--------	----	---	---	------	---------------

Moka.

CHAPA DE ACERO

STEEL PLATE
PLAQUE D'ACIER
STAHLPLATTE
PLACA DE AÇO



Xylan®



Molde Desmontable Corazón

Heart Springform Mold
Moule Démontable Coeur
Herz Springform
Forma Coração Desmontável



ref.	L (cm)	H (cm)	📦	Bar Code
826022	22	7,50	6/36	8411922086263

Molde Desmontable Cuadrado

Square Springform Mold
Moule Démontable Carré
Quadratische Springform
Forma Quadrada Desmontável



ref.	L (cm)	W (cm)	H (cm)	📦	Bar Code
825924	24	24	7	6	8411922086256

Molde Desmontable Cuadrado con Base Extra

Square Springform Mold with Extra Base
 Moule D montable Carr  avec Base Extra
 Quadratische Springform mit Extra Boden
 Forma Quadrada Desmont vel com Base Extra



ref.	L (cm)	W (cm)	H (cm)	�	Bar Code
826517	17	17	8	6	8411922090765
826524	24	24	8,30	6	8411922090956

Molde Cuadrado Alto

Square Deep Springform Mold
 Moule D montable Carr  Haut
 Quadratische Tiefe Springform
 Forma Quadrada Desmont vel Alta



ref.	L (cm)	H (cm)	�	Bar Code
821024	24	10	6	8411922453423

Molde Desmontable Cake con Base Extra

Cake Springform Mold with Extra Base
 Moule D montable Cake avec Base Extra
 Kastenform Springform mit Extra Boden
 Forma Bolo Ingl s Desmont vel com Base Extra



ref.	L (cm)	W (cm)	H (cm)	�	Bar Code
827130	30	11	8	6	8411922090963

Molde Desmontable Rectangular con Base Extra

Rectangular Springform Mold with Extra Base
 Moule D montable Rectangulaire Base Extra
 Rechteckige Springform mit Extra Boden
 Forma Retangular Desmont vel com Base Extra



ref.	L (cm)	W (cm)	H (cm)	�	Bar Code
826628	28	18	7	6/12	8411922090772

Molde Desmontable Redondo

Round Springform Mold
 Moule D montable Rond
 Springform
 Forma Redonda Desmont vel



ref.	� (cm)	H (cm)	�	Bar Code
820114	14	4,80	6/24	8411922458312
820116	16	4,50	6	8411922455915
820118	18	6	6	8411922451641
820120	20	6,80	6	8411922083712
820122	22	6,50	6	8411922091632
820124	24	6,50	6	8411922900248
820126	26	6,50	6	8411922900262
820128	28	6,50	6	8411922900286
820130	30	6,50	6	8411922453362

Molde Desmontable Alto

Deep Springform Mold
 Moule Démontable Haut
 Tiefe Springform
 Forma Desmontável Alta



ref.	∅ (cm)	H (cm)	📦	Bar Code
820920	20	10	6	8411922453409
820926	26	10	6	8411922453416

Molde Cake

Cake Mold
 Moule Cake
 Kastenform
 Forma Bolo Inglês



ref.	L (cm)	W (cm)	H (cm)	Lts	📦	Bar Code
820320	20	11	8	1,20	6	8411922457988
820325	25	11	8	1,70	6	8411922902259
820330	30	11	8	2	6	8411922902303
820335	35	11	8	2,30	6	8411922902358

Molde Desmontable Redondo con Base Extra

Round Springform Mold with Extra Base
 Moule Démontable Rond Avec Base Extra
 Runde Springform mit Extra Boden
 Forma Redonda Desmontável com Base Extra



ref.	∅ (cm)	H (cm)	📦	Bar Code
826420	20	7	6	8411922470789
826426	26	10	6	8411922090758

Set 4 Flaneros

Set 4 Creme Caramel Molds
 Jeu 4 Moules Crème Caramel
 Set 4 Puddingform
 Jogo 4 Formas para Pudim Flan



ref.	∅ (cm)	H (cm)	📦	Bar Code
827800	8	5	6/24	8411922091724

Molde Rizado

Fluted Mold
 Moule Dentelé
 Geriffelte Torten Förmchen
 Forma Canelada



ref.	∅ (cm)	H (cm)	Lts	📦	Bar Code
824328	28	3	1,15	6/24	8411922071672

Molde Muffin 12 Cavidades

Muffin Pan 12 Cups
 Moule à Muffins 12 Cavités
 Muffinform 12 Kavitäten
 Forma Muffin 12 Cavidades



ref.	L (cm)	W (cm)	H (cm)	∅ (cm)	📦	Bar Code
820501	35	27	3,20	7	6/24	8411922781014

Molde Mini Muffin 24 Cavidades

Mini Muffin Pan 24 Cups
 Moule 24 Mini Muffin
 Mini Muffinform 24 Kavitäten
 Forma Mini Muffin 24 Cavidades



ref.	L (cm)	W (cm)	H (cm)	Ø (cm)	📦	Bar Code
820510	38	26	2,30	5	6	8411922453379

Molde Muffin 6 Cavidades

Muffin Pan 6 Cups
 Moule à Muffins 6 Cavités
 Muffinform 6 Kavitäten
 Forma Muffin 6 Cavidades



ref.	L (cm)	W (cm)	H (cm)	Ø (cm)	📦	Bar Code
823200	26	18,10	3,20	7	6/36	8411922071283

Molde Muffin 12 Cavidades con Tapa + Soporte

Muffin Pan 12 Cups with Lid + Stand
 Moule 12 Muffin avec Couvercle + Support
 Muffinform 12 Kavitäten mit Deckel + Ständer
 Forma Muffins 12 Cavidades com Tampa + Suporte



ref.	L (cm)	W (cm)	📦	Bar Code
828000	37	29	1/6	8411922091762

Molde Mini Muffin 12 Cavidades

Mini Muffin Pan 12 Cups
 Moule 12 Mini Muffin
 Mini Muffinform 12 Kavitäten
 Forma Mini Muffin 12 Cavidades



ref.	L (cm)	W (cm)	H (cm)	📦	Bar Code
826900	25	19	2	6/36	8411922090819

Molde Muffin 12 Cavidades + 12 Cápsulas

Muffin Pan 12 Cups + 12 Cases
 Moule 12 Muffin + 12 Barquettes
 Muffinform 12 Kavitäten + 12 Kapseln
 Forma Muffins 12 Cavidades + 12 Cápsulas



ref.	L (cm)	W (cm)	H (cm)	📦	Bar Code
827000	39	27	3,50	6/12	8411922090826

Molde Halloween 12 Cavidades

Halloween Mold 12 Cavities
 Moule Halloween 12 Cavités
 Halloween Form mit 12 Kavitäten
 Forma Halloween 12 Cavidades



ref.	L (cm)	W (cm)	Bar Code
827700	44	28	8411922091717

Molde Navidad 12 Cavidades

Christmas Mold 12 Cavities
 Moule de Noël 12 Cavités
 Weihnachtsform 12 Kavitäten
 Forma de Natal 12 Cavidades



ref.	L (cm)	W (cm)		Bar Code
828400	36	30	6/12	8411922433647

Molde Doughnut 6 Cavidades

Doughnut Mold 6 Cavities
 Moule Doughnut 6 Cavités
 Doughnut Form 6 Kavitäten
 Forma Doughnut 6 Cavidades

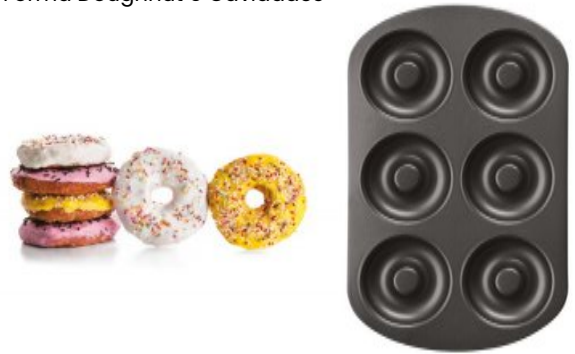

ref.	∅ (cm)		Bar Code
827300	8	6/24	8411922091670

Molde Redondo Inclinado

Topsy-Turvy Cake Pan
 Moule Rond Incliné
 Topsy Turvy Backform
 Forma Redonda Inclinada

- **Acero con Antiadherente**
- **Steel With Non-Stick Coating**



ref.	∅ (cm)	H (cm)		Bar Code
827920	20	10	6	8411922091731
827921	21,50	10	6	8411922091748
827926	26	10	6	8411922091755



Molde Pandoro

Pandoro Mold
 Moule Pandoro
 Pandoro-Förmchen
 Forma Pandoro



ref.	∅ (cm)	H (cm)		Bar Code
824910	23	17,50	1/6	8411922453751

Molde Mini Tarta 3 Pisos

Mini 3 Tier Cake Mold
 Moule Mini Tarte 3 Étages
 Mini-Kuchenform mit 3 Etagen
 Forma Mini Bolo 3 Camadas



ref.	∅ (cm)	H (cm)		Bar Code
827400	6+8,3+10	4,3+4,5+4,5	1/6/12	8411922091687

Molde 4 Baguettes / Tejas

4 Baguettes / Tiles Mold
 Moule 4 Baguettes / Tuiles
 Form 4 Baguettes / Ziegel
 Forma 4 Baguettes / Telhas



ref.	L (cm)	W (cm)		Bar Code
824804	38	33	6	8411922083644

Molde 3 Baguettes / Tejas

3 Baguettes / Tiles Mold
 Moule 3 Baguettes / Tuiles
 Form 3 Baguettes / Ziegel
 Forma 3 Baguettes / Telhas



ref.	L (cm)	W (cm)		Bar Code
824803	38	24	6	8411922447156

Molde 2 Baguettes / Tejas

2 Baguettes / Tiles Mold
 Moule 2 Baguettes / Tuiles
 Form 2 Baguettes / Ziegel
 Forma 2 Baguettes / Telhas



ref.	L (cm)	W (cm)		Bar Code
824802	38	16,50	6	8411922083637

Molde Rectangular con Fondo Móvil

Rectangular Loose Bottom Mold
 Moule Rectangulaire Amovible
 Rechteckige Abnehmbar Backform
 Forma Retangular Fundo Móvel



ref.	L (cm)	W (cm)	H (cm)		Bar Code
823036	36	13	2,50	6/24	8411922068931

Molde Rectangular Rizado con Fondo Móvil

Rectangular Fluted Loose Bottom Mold
 Moule Rectangulaire Dentelé Amovible
 Rechteckige Geriffelte Torten Abnehmbar Förmchen
 Forma Retangular Canelada Fundo Móvel



ref.	L (cm)	W (cm)		Bar Code
823528	28	20	6/24	8411922079609

Flanero Rizado

Brioche Mold
 Moule à Brioche
 Briocheform
 Forma de Pudim Flan Canelada



ref.	∅ (cm)	H (cm)	Lts		Bar Code
824121	21	7	1,45	6/36	8411922071634

Molde Savarín

Savarin Mold
Moule Savarin
Savarin Förmchen
Forma Savarin



ref.	∅ (cm)	H (cm)		Bar Code
821824	24	8	6/18	8411922076806

Molde Savarín Alto

Deep Savarin Mold
Moule Savarin Haut
Tiefe Savarin Förmchen
Forma Savarin Alta



ref.	∅ (cm)	H (cm)	Lts		Bar Code
822823	24	10	3	6/12	8411922068290

Molde Cuadrado

Square Mold
Moule Carré
Quadratische Backform
Forma Cuadrada



ref.	L (cm)	W (cm)	H (cm)		Bar Code
823624	24	24	4,50	6/36	8411922071337

Molde Kugelhof

Kugelhof Cake Mold
Moule Kugelhof
Kugelhof Form
Forma Kugelhof



ref.	∅ (cm)	H (cm)	Lts		Bar Code
820622	22	10	3	1/6/24	8411922782226

Molde Rizado Movil

Fluted Loose Bottom Mold
Moule Dentelé Amovible
Geriffelte Torten Abnehmbar Förmchen
Forma Canelada Fundo Móvel



ref.	∅ (cm)	H (cm)	Lts		Bar Code
824228	28	3	1,50	6/24	8411922071658

Molde Pudín con Tapa

Pudding Mold with Lid
Moule Pudding avec Couvercle
Puddingform mit Deckel
Forma de Pudim com Tampa



ref.	∅ (cm)		Bar Code
825016	16	4	8411922078909
825020	20	4	8411922078916

Molde Tronco

Tree Trunk Mold
Moule Tronc
Baumstammform
Forma de Tronco



ref.	L (cm)	H (cm)		Bar Code
827250	26	7	6	8411922457698

Molde Brazo Gitano

Swiss Roll Tray
Plaque à Biscuit Roulé
Backblech für Biskuitrolle
Forma para Torta



ref.	L (cm)	W (cm)	H (cm)		Bar Code
822141	41	28	2	6/24	8411922423815

Molde Huevo de Pascua

Easter Egg Mold
Moule à Oeufs de Pâques
Ostereierform
Forma Ovo de Páscoa



ref.	L (cm)	W (cm)	H (cm)	📦	Bar Code
823926	26	21	8,30	6/36	8411922071382

Molde Desmontable 2 Usos

Springform Mold 2 Uses
Moule Démontable 2 Usages
2-Purpose Springform
Forma Desmontável 2 Usos



ref.	∅ (cm)	H (cm)	📦	Bar Code
820224	24	6,50	4	8411922901245
820226	26	6,50	4	8411922901269
820228	28	6,50	4	8411922901283

Molde Alto

Pie Mold
Moule Haut
Hohe Backform
Forma de Bolo Alta



ref.	∅ (cm)	H (cm)	Lts	📦	Bar Code
824426	26	4,50	1,95	6/24	8411922071702

Molde para Pan

Bread Mold
Moule à Pain
Brotform
Forma para Pão



ref.	L (cm)	W (cm)	H (cm)	📦	Bar Code
822630	30	15	10	6	8411922208023

Molde Corazón

Heart Mold
Moule Coeur
Herzform
Forma Coração



ref.	L (cm)	H (cm)	📦	Bar Code
820724	24	4	6/36	8411922423785

Molde Semicircular

Semicircular Mold
Moule Semi-Circulaire
Halbrunde Form
Forma Semicircular



ref.	L (cm)	H (cm)	Lts	📦	Bar Code
822530	30	5,50	1,20	6/48	8411922206425

Molde Madalenas 12 Cavidades

Madeleines Pan 12 Cups
Moule Madeleines 12 Cavités
Muffinform 12 Kavitäten
Forma Muffin 12 Cavidades



ref.	L (cm)	W (cm)	📦	Bar Code
820502	24	21	6/36	8411922781021

Escalfador de Huevos

Egg Poacher
Pocheuse à Oeufs
Eier-Pochierer
Escalfador de Ovos



ref.	W (cm)	📦	Bar Code
825603	15	6/72	8411922082241

Molde Panettone

Panettone Mold
Moule Panettone
Panettone Springform
Forma Panettone



ref.	∅ (cm)	H (cm)	📦	Bar Code
826712	12	10	6/12	8411922090789
826716	16	13	6	8411922090796

Molde Canutillo

Cream Roll Mold
Moule à Cigarette
Sahnerollenform
Forma de Rolitos



ref.	L (cm)	∅ (cm)	📦	Bar Code
821600	14	2	6/72	8411922904086

Molde Cornete

Cream Horn Mold
Moule à Cornet
Sahnehornform
Forma Cornucopia



ref.	L (cm)	∅ (cm)	📦	Bar Code
821700	12	3,50	6/96	8411922904093

Molde para Huevo Redondo

Round Egg Mold
Moule Oeuf Rond
Runde Eierform
Molde para Ovo Redondo



ref.	∅ (cm)	📦	Bar Code
824701	10	6/72	8411922079722

Molde para Huevo Corazon

Heart Egg Mold
Moule Oeuf Coeur
Herz Eierform
Molde para Ovo Coração



ref.	L (cm)	📦	Bar Code
824700	10	6/72	8411922079715

Molde para Huevo Cuadrado

Egg Square Mold
Moule Oeuf Carré
Quadratische Eierform
Molde para Ovo Quadrado



ref.	L (cm)	📦	Bar Code
824703	10	6/72	8411922079739

Molde Osito

Teddy Bear Mold
Moule Petit Ours
Teddybär Backform
Forma Ursinho



ref.	L (cm)	W (cm)	H (cm)	📦	Bar Code
823410	10	9,50	2,70	6/144	8411922071313

Molde Aspíic

Aspic Mold
Moule Aspic
Aspic Form
Forma Aspic



ref.	L (cm)	H (cm)	📦	Bar Code	
824600	8	6	1/6/144	8411922081824	BLISTER 2 uds
824608	8	6	12/288	8411922079708	

Molde Pizza Crispy

Crispy Pizza Mold
Moule Pizza Crispy
Crispy Pizzaform
Forma para Pizza Crispy



ref.	∅ (cm)	H (cm)	📦	Bar Code
821928	28	1,80	6/48	8411922904123
821932	32	1,80	6/36	8411922904130

Set 6 Moldes para Baba / Dariole

Set 6 Molds for Baba / Dariole
Jeu 6 Moules à Baba / Dariole
6er-Set Formen für Baba/Dariole
Conjunto 6 Formas para Baba/Dariole



ref.	∅ (cm)	H (cm)	ml	📦	Bar Code
822310	6,50	6	100	1/10/20	8411922470833

Mini Moka.

CHAPA DE ACERO
STEEL PLATE
PLAQUE D'ACIER
STAHLPLATTE
PLACA DE AÇO



Molde Savarin

Savarin Mold
Moule Savarin
Savarin Förmchen
Forma Savarin



ref.	∅ (cm)	H (cm)	Lts	📦	Bar Code
821812	12	5	0,25	6/144	8411922904109

Molde Corazón Rizado

Fluted Heart Mold
Moule à Coeur Dentelé
Geriffelte Herzform
Forma Coração Canelada



ref.	L (cm)	📦	Bar Code
828110	10	12/48	8411922093841

Molde Rizado

Fluted Mold
Moule Dentelé
Geriffelte Torten Förmchen
Forma Canelada



ref.	∅ (cm)	H (cm)	📦	Bar Code
820410	10	1,80	12/72	8411922435207
820412	12	2	12/72	8411922903126

Molde Cake

Cake Mold
Moule Cake
Kastenform
Forma Bolo Inglês



ref.	L (cm)	H (cm)	Lts	📦	Bar Code
820314	14	4,80	0,40	12/144	8411922902143

Molde Rizado Movil

Fluted Loose Bottom Mold
Moule Dentelé Amovible
Geriffelte Torten Abnehmbar Förmchen
Forma Canelada Fundo Móvel



ref.	∅ (cm)	H (cm)	Lts	📦	Bar Code
822912	12	2	0,20	12/72	8411922209488

Molde Canele

Canele Mold
Moule Cannelé
Canele Form
Forma Canele



ref.	∅ (cm)	📦	Bar Code
828800	6	6/24	8411922434484

Molde Desmontable Redondo

Round Springform Mold
Moule Démontable Rond
Springform
Forma Redonda Desmontável



ref.	∅ (cm)	H (cm)	📦	Bar Code
820110	10	5	6/72	8411922091625
820112	12	4,50	6/24	8411922900125

Molde Corazón Desmontable

Heart Springform Mold
Moule Coeur Démontable
Herz Springform
Molde Coração Desmontável



ref.	L (cm)	H (cm)	📦	Bar Code
824511	11	5	6/24	8411922077384

Clásica.

ACERO INOXIDABLE
STAINLESS STEEL
ACIER INOXYDABLE
ROSTFREIER STAHL
AÇO INOXIDÁVEL

Molde Desmontable Inox

Stainless Steel Springform Mold
Moule Démontable Inoxydable
Springform aus Edelstahl
Forma Desmontável Inox



- Acero Inoxidable 18%
- Stainless Steel 18%

ref.	∅ (cm)	H (cm)	Lts	📦	Bar Code
650218	18	5,70	1,30	6/12	8411922083552
650223	23	6,50	2,30	6/12	8411922083569
650226	26	6,60	3,10	6/12	8411922083576

Set 6 Tapas para Flanero de 8cm

Set 6 Lids for 8cm Creme Caramel Cup
Set 6 Couverts pour Moule à Crème Caramel 8cm
Set 6 Deckel für 8cm Puddingform
Jogo de 6 Tampas para Pudim Flan de 8cm



- Para flaneros de 8cm
- For 8cm cups



ref.	∅ (cm)	📦	Bar Code
651000	8,70	6/60	8411922455557

Flanero con Tapa Inoxidable

Stainless Steel Creme Caramel Mold with Lid
Moule à Crème Caramel avec Couverture Inoxydable
Wasserbadform mit Edelstahl Deckel
Forma Pudim Flan com Tampa Inoxidavel



- Acero Inoxidable 18/10
- Stainless Steel 18/10

ref.	∅ (cm)	Lts	📦	Bar Code
651616	16	1,20	6/24	8411922207262
651618	18	2	6/12	8411922207279
651620	20	2,60	6/12	8411922207323

Flanero Individual

Single Creme Caramel Mold
Moules à Crème Caramel
Einzel Puddingform
Forma Individual para Pudim Flan



ref.	Ø (cm)	H (cm)	📦	Bar Code
721707	7	5,10	12/120	8411922079968
721708	8	5,80	12/120	8411922079975

Flanero Individual Inoxidable

Stainless Steel Individual Creme Caramel Mold
Moules à Crème Caramel Inoxydables
Einzel Puddingform Edelstahl
Forma Individual para Pudim Flan Inoxidavel



ref.	Ø (cm)	H (cm)	Lts	📦	Bar Code
651005	5	4	0,08	24/192	8411922423402
651006	6	5	0,10	24/192	8411922423228
651007	7	5	0,15	24/192	8411922423235
651008	8	5	0,20	24/192	8411922423242
651009	9	5,50	0,30	24/192	8411922115024

Molde 3 Baguettes / Tejas

3 Baguettes / Tiles Pan
Plaque 3 Baguettes / Tuiles
Form für 3 Baguettes / Ziegel
Placa 3 Baguettes / Telhas

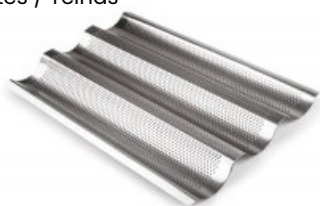

ref.	L (cm)	W (cm)	📦	Bar Code
682103	38	25	6/24	8411922455625

Molde Cake Inoxidable

Stainless Steel Cake Mold
Moule Cake Inoxydable
Kastenform aus Edelstahl
Forma de Bolo Inglês Inoxidavel



ref.	L (cm)	H (cm)	Lts	📦	Bar Code
650130	30	7,50	2	6	8411922759303

Molde Cornete (6 uds.)

Cream Horn Mold
Moule à Cornet
Sahnehornform
Forma Cornucopia



ref.	L (cm)	Ø (cm)	Bar Code
802000	11	3,50	8411922717136

Molde Canutillo (4 uds.)

Cream Roll Mold
Moule à Cigarette
Schaumrollen-Formen
Forma de rolitos



ref.	L (cm)	Ø (cm)	📦	Bar Code
730000	14	2	6/72	8411922439755

Molde Canutillo Mini (12 uds.)

Cream Roll Mini Mold
Moule Cigarette Mini
Mini Sahnerollenform
Forma de Rolitos Mini



ref.	L (cm)	Ø (cm)	📦	Bar Code
802300	6,50	1,60	6/72	8411922440263

Molde Canutillo (6 uds.)

Cream Roll Mold
Moule à Cigarette
Sahnerollenform
Forma de Rolitos



ref.	L (cm)	∅ (cm)	Bar Code
802200	14	2	8411922719109

Molde à Bûche Triangular

Triangular à Bûche Mold
Moule à Bûche Triangulaire
Dreieckige à Bûche-Form
Forma à BûcheTriangular



ref.	L (cm)	W (cm)	H (cm)	∅	Bar Code
717310	30	9,50	7,30	1/6/12	8411922447552

Molde à Bûche Semicircular

Semicircular à Bûche Mold
Moule à Bûche Semi-Circulaire
Halbrunde à Bûche-Form
Forma à Bûche Semicircular



ref.	L (cm)	W (cm)	H (cm)	∅	Bar Code
717300	30	9,50	7,30	1/6/12	8411922447545

Empanadera

Empanada Tray
Plat à Empanada
Tablett Empanadera
Tabuleiro Empanada



ref.	L (cm)	W (cm)	H (cm)	∅	Bar Code
652640	40	30	3,50	4/12	8411922078510
652645	45	35	3,50	4/12	8411922078527

Molde Extensible Rectangular

Extendable Rectangular Mold
Moule Extensible Rectangulaire
Ausziehbare Rechteckige Form
Forma Extensível Retangular



ref.	L (cm)	W (cm)	H (cm)	∅	Bar Code
790600	46+24	38+20	6	1/6/24	8411922090550

Molde Extensible Circular

Extendable Round Pastry Ring
Cercle Rond Extensible
Ausziehbarer Runder Gebäckring
Forma Extensível Circular



ref.	∅ (cm)	H (cm)	Lts	∅	Bar Code
717216	16-30	5,50	6	1/6/12	8411922077605

Molde Semiesfera

Semisphere Mold
Moule Semi-Sphère
Halbkugelform
Forma Semiesfera



ref.	∅ (cm)	H (cm)	∅	Bar Code
723008	8	4	12/240	8411922080605

Soporte para Molde Semiesférico-Piramide

Support for Semi-Spherical & Pyramid Mold
Support de Moule Semi-Sphérique-Pyramide
Halterung für Halbkugelförmige-Pyramide Form
Soporte para Molde Hemisférico-Piramide



ref.	L (cm)	W (cm)	H (cm)	∅	Bar Code
726500	40	10	5	1/6/36	8411922083620



Molde Angel Food

Angel Food Mold
Moule Angel Food
Angel Food Form
Forma Angel Food



ref.	∅ (cm)	H (cm)	📦	Bar Code
787800	25	14	1/4	8411922088083

Molde Savarín

Savarin Mold
Moule Savarin
Backform Savarin
Forma Savarin



ref.	∅ (cm)	H (cm)	Lts	📦	Bar Code
140626	26	7,50	2,70	6	8411922113266
140628	28	8,30	3	6	8411922113280

Molde Pastel de Nata (6 uds.)

Cream Cake Mold
Moule à Gâteaux à la Crème
Form für Puddingtörtchen
Forma Pastel de Nata



ref.	∅ (cm)	H (cm)	📦	Bar Code
142000	7	3	6	8411922439700

Flanero Individual

Individual Creme Caramel Mold
Moule à Crème Caramel Individuel
Einzel Puddingform
Forma Individual para Pudim Flan



ref.	∅ (cm)	H (cm)	Lts	📦	Bar Code
140807	7	5	0,13	24/144	8411922115079
140808	8	5	0,18	24/144	8411922115086
140809	9	5,40	0,25	24/144	8411922115093

Acero Estañado.

ACERO ESTAÑADO
STAINLESS STEEL
ACIER INOXYDABLE
ROSTFREIER STAHL
AÇO INOXIDÁVEL



Molde Desmontable

Springform Mold
Moule Démontable
Springform
Forma Desmontável



ref.	∅ (cm)	H (cm)	📦	Bar Code
800122	22	6,50	6	8411922700220
800124	24	6,50	6	8411922700244
800126	26	6,50	6	8411922700268

Molde Cake Promo

Promo Cake Mold
Moule Cake Promo
Kastenform Promo
Forma Bolo Inglês Promo



ref.	L (cm)	H (cm)	📦	Bar Code
810525	25	8	6	8411922708004
810530	30	8	6	8411922708011

Molde Pizza Crispy

Crispy Pizza Mold
Moule Pizza Crispy
Crispy Pizzaform
Forma para Pizza Crispy



ref.	∅ (cm)	Lts	📦	Bar Code
802428	28	1,80	6/48	8411922721287

Moldes Desechables.

PAPEL
PAPER
PAPIER
PAPIER
PAPEL



Molde Panettone Desechable (5 uds.)

Disposable Panettone Molds
Moules Panettone Jetables
Einweg-Panettone-Formen
Molde Descartável para Panettone



ref.	∅ (cm)	H (cm)	📦	Bar Code	
746500	7,50	5	6	8411922454482	90g (10 uds)
746505	14	10,50	6	8411922436877	500g
746509	18	11,50	6	8411922436884	900g

Molde Pan Desechable (4 uds.)

Disposable Bread Mold
Moule Jetable pour Pain
Einweg-Brotform
Forma descartável para Pao



ref.	L (cm)	W (cm)	H (cm)	📦	Bar Code
215000	18,50	10,50	6	6	8411922454963

Molde Individual Desechable (12 uds.)

Single Disposable Mold
Moule Jetable Individuel
Einzelne Einwegform
Forma descartável Individual



ref.	∅ (cm)	H (cm)	📦	Bar Code
215005	11	2,50	6	8411922455014

Molde Cake Individual Desechable (12 uds.)

Single Disposable Cake Mold
Moule Jetable Cake Individuel
Einzelne Einweg-Kastenform
Forma Bolo Inglês Descartável Individual



ref.	L (cm)	W (cm)	H (cm)	📦	Bar Code
215006	10	5,50	4	6	8411922455021

Molde Alto Desechable (4 uds.)

Tall Disposable Mold
Moule Jetable Haut
Hohe Einwegform
Forma descartável Alto



ref.	∅ (cm)	H (cm)	📦	Bar Code
215004	21	6,50	6	8411922455007

Molde Savarin Desechable (4 uds.)

Disposable Savarin Mold
Moule Jetable Savarin
Einweg-Gugelhupfform
Forma descartável Savarin



ref.	∅ (cm)	H (cm)	📦	Bar Code
215003	21	6,50	6	8411922454994

Molde Cake Desechable (4 uds.)

Disposable Cake Mold
Moule Jetable Cake
Einweg-Kastenform
Forma Bolo Inglês Descartável



ref.	L (cm)	W (cm)	H (cm)	📦	Bar Code
215001	21	8	5	6	8411922454970
215002	25	10	7	6	8411922454987



Ceramic.

CERÁMICA REFRACTARIA
REFRACTORY CERAMIC
CÉRAMIQUES RÉFRACTAIRES
FEUERFESTE KERAMIKEN
CERÂMICAS REFRACTÁRIAS



Molde para Pan con Tapa

Bread Pan with Lid
Moule avec Couvercle pour Pain
Brotbackform Mit Deckel
Forma de Pão com Tampa



ref.	L (cm)	W (cm)	H (cm)	📦	Bar Code
685900	24,50	10	10	1/4	8411922459036
685910	24,50	10	10	1/4	8411922459043

BURDEOS
AZUL / BLUE

Molde Ramequin (4 uds.)

Ramekin Mold
Ramequin
Auflaufförmchen
Forma Ramequim



ref.	∅ (cm)	H (cm)	Lts	📦	Bar Code
230010	9	5	0,17	3	8411922077377

Banneton.

RATÁN
RATTAN
ROTIN
RATTAN
VIME



Molde Pan Baguette

Baguette Bread Mold
Moule Pain Baguette
Brotform Baguette
Molde para Pão Baguette



ref.	L (cm)	W (cm)	H (cm)		Bar Code
680305	44	10	5,50	6/48	8411922449303

Molde Pan Rectangular

Rectangular Bread Mold
Moule Pain Rectangulaire
Brotform Rechteckig
Molde para Pão Rectangula



ref.	L (cm)	W (cm)	H (cm)		Bar Code
680303	29	15	8	6/36	8411922449280

Molde Pan Corona

Crown Bread Mold
Moule Pain Couronne
Brotform Kranz
Molde para Pão Coroa



ref.	∅ (cm)	H (cm)		Bar Code
680304	28	8	6/24	8411922449297

Molde Pan Oval

Oval Bread Mold
Moule Pain Ovale
Brotform Oval
Molde para Pão Oval



ref.	L (cm)	W (cm)	H (cm)		Bar Code
680302	27	13	6,50	6/36	8411922449273

Molde Pan Redondo

Round Bread Mold
Moule Pain Rond
Brotform Rund
Molde para Pão Redondo



ref.	∅ (cm)	H (cm)		Bar Code
680300	22	8,50	6/36	8411922449259
680301	25	8,50	6/36	8411922449266



Kristall.

BOROSILICATO
BOROSILICATE
BOROSILICATE
BOROSILIKAT
BOROSILICATE



Fuente para Horno Rectangular

Rectangular Roast Pan
Plat à Rôtir Rectangulaire
Bratreine Rechteckig
Tabuleiro Retangular



ref.	L (cm)	W (cm)	H (cm)	Lts		Bar Code
480723	23	15	5	0,70	6	8411922085464
480730	30	18	5	1,60	6	8411922085471
480734	34	21	5	2,20	6	8411922085488
480740	40	23	6,50	2,90	6	8411922085495

Fuente para Horno Rectangular Alta

High Rectangular Roast Pan
Plat à Rôtir Rectangulaire Haut
Hohe Bratreine Rechteckig
Tabuleiro Retangular Alto



ref.	L (cm)	W (cm)	H (cm)	Lts		Bar Code
480840	40	25	7	4,10	6	8411922085501

Fuente Horno Cuadrada

Square Roast Pan
Plat à Rôtir Carré
Quadratische Bratrine
Tabuleiro Quadrado



ref.	L (cm)	W (cm)	H (cm)	Lts	📦	Bar Code
480625	25	22	5	1,80	6	8411922085440

Molde Alto

Pie Mold
Moule Haut
Hohe Backform
Forma de Bolo Alta



ref.	∅ (cm)	H (cm)	Lts	📦	Bar Code
480226	26	6	1,20	6	8411922085372

Molde Rizado

Fluted Mold
Moule à Tarte Dentelé
Tarteform
Forma de Tarte Canelada



ref.	∅ (cm)	H (cm)	Lts	📦	Bar Code
480528	28	3,50	1,20	6	8411922085433

Fuente para Horno Rectangular con Tapa Kristall

Kristall Rectangular Roast Pan with Lid
Plat à Rôtir Rectangulaire avec Couvercle Kristall
Rechteckige Bratrine mit Deckel
Tabuleiro Rectangular com Tampa Kristall



ref.	L (cm)	W (cm)	H (cm)	Lts	📦	Bar Code
687730	30,50	18,60	5,30	1,60	4	8411922459852
687735	35,50	21,50	5,60	2,20	4	8411922459869

Set 3 Fuentes Rectangulares

Set 3 Rectangular Roast Pans
Jeu 3 Plats à Rôtir Rectangulaires
Set 3 Bratneinen Rechteckig
Jogo 3 Tabuleiros Retangulares

ref.	L (cm)	W (cm)	H (cm)	Lts	📦	Bar Code
480700	29,5+34,5+39,3	17+20,5+23	5+5+6,50	1,6+2,2+3	1/3	8411922085457

Fuente para Horno Oval

Oval Roast Pan
Plat à Rôtir Ovale
Bratrine Oval
Tabuleiro Oval



ref.	L (cm)	W (mm)	H (cm)	Lts	📦	Bar Code
480123	23	16	5	1	6	8411922085327
480126	26	18	6	1,50	6	8411922085334
480130	30	21	6	2,40	6	8411922085341
480135	35	25	6,50	3,20	6	8411922085358
480140	40	27	6,50	4	6	8411922085365

Flanero Rizado

Brioche Fluted Mold
Moule à Brioche
Briocheform
Forma de Pudim Flan Canelada



ref.	∅ (cm)	H (cm)	Lts	📦	Bar Code
480420	20	8	1,05	6	8411922085426

Molde Cake

Cake Mold
Moule Cake
Kastenform
Forma de Bolo Inglês



ref.	L (cm)	W (mm)	H (cm)	Lts	📦	Bar Code
480024	24	13	7	1	6	8411922085297
480027	27	14	7	1,50	6	8411922085303
480030	30	12	7	2,20	6	8411922090017

Bol

Bowl
Bol
Schüssel
Tigela



ref.	∅ (cm)	H (cm)	Lts	📦	Bar Code
480319	19	9	1,80	6	8411922085396
480321	21	10	2,50	6	8411922085402
480324	24	11	3,50	6	8411922085419



Freidora de Aire / Horno.

Freidora de Aire / Horno.

Recipientes Esmaltados.

ACERO ESMALTADO VITRIFICADO
VITRIFIED ENAMELED STEEL
ACIER ÉMAILLÉ VITRIFIÉ
KERAMISCH EMAILLIERTER STAHL
AÇO ESMALTADO VITRIFICADO

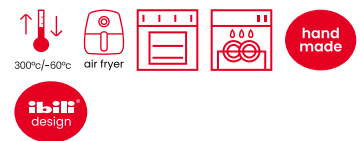

Recipiente para Freidora de Aire Redondo

Round Container for Air Fryer
Récipient pour Friteuse à Air Rond
Runde Behälter für Heißluftfritteuse
Recipiente Redondo para Fritadeira a Ar



ref.	∅ (cm)	∅ (cm)	H (cm)		Bar Code
919916	17,80	16	6,80	1/6	8411922470550
919918	20	18	6,80	1/6	8411922470567
919920	21,50	19,50	7	1/6	8411922470574



Freidora de Aire / Horno.

Bandejas Desechables.

PAPEL
PAPER
PAPIER
PAPIER
PAPEL



Bandeja Desechable para Freidora de Aire Redonda (50 uds.)

Disposable Paper Air Fryer Tray Round (50 pcs)
Jetable Feuilles pour Friteuse à Air Ronde (50 pcs)
Backpapier-Schalen für die Heißluftfritteuse Rund (50 stk.)
Bandeja de Papel Para Fritadeira de Ar Redonda (50 uds.)



ref.	∅ (cm)	H (cm)		Bar Code
688516	16	4,50	6/24	8411922470512

Bandeja Desechable para Freidora de Aire Cuadrada (50 uds.)

Disposable Paper Air Fryer Tray Square (50 pcs)
Jetable Feuilles pour Friteuse à Air Carré (50 pcs)
Backpapier-Schalen für die Heißluftfritteuse Viereckig (50 stk.)
Bandeja de Papel Para Fritadeira de Ar Quadrada (50 uds.)



ref.	L (cm)	W (cm)	H (cm)		Bar Code
688520	20	20	4,50	6/24	8411922470529

Rustideras.



Fuente para Horno-Plancha Induplus

Induplus Roast Pan-Grill
Plat à Rôtir-Grill Induplus
Bratreine-Grillpfanne Induplus
Tabuleiro-Grelhador Induplus



- **Aluminio Fundido**
- **Doble uso, como rustidera para horno y plancha, para todo tipo de fuegos**
- Cast Aluminum
- Double use as roaster for oven and grill for all kind of stoves



ref.	L (cm)	W (cm)	H (cm)	📦	Bar Code
401534	40	26	6,50	4	8411922083781

Fuente para Horno Blu

Blu Roast Pan
Plat à Rôtir Blu
Bratreine Blu
Tabuleiro Blu



- **Aluminio**
- Aluminium

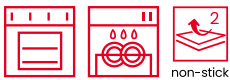

ref.	L (cm)	W (cm)	H (cm)	Lts	📦	Bar Code
330140	40	33	7	7,50	6	8411922160130

Rustidera Blu

Blu Roast Pan
Plat à Rôtir Blu
Bratreine Blu
Tabuleiro Blu



- **Aluminio**
- Aluminium

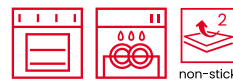

ref.	L (cm)	W (cm)	H (cm)	Lts	📦	Bar Code
330029	29	20	5	2,20	6	8411922160079
330040	40	27	6	5,50	6	8411922160093

Rustidera Venus

Venus Roast Pan
Plat à Rôtir Venus
Bratreine Venus
Tabuleiro Venus



- **Aluminio**
- Aluminium



ref.	L (cm)	W (cm)	H (cm)	Lts	☐	Bar Code
300929	29	20	5	2,20	6	8411922218299
300935	35	24	6	3,50	6	8411922218367
300940	40	27	6	5,50	6	8411922218404

Fuente para Horno Venus

Venus Roast Pan
Plat à Rôtir Venus
Bratreine Venus
Tabuleiro Venus



- **Aluminio**
- Aluminium



ref.	L (cm)	W (cm)	H (cm)	Lts	☐	Bar Code
301140	40	33	7	7,50	6	8411922262407

Rustidera con Asas Metálicas Clásica

Clásica Roast Pan with Metallic Handles
Plat à Rôtir avec Anses Métalliques Clásica
Bratreine mit Metallgriffen Clásica
Tabuleiro com Asas de Metal Clásica



- **Acero Inoxidable**
- **Asas Metálicas**
- **Asa Abatible**
- Stainless Steel
- Metallic Handles
- Folding Handle



ref.	L (cm)	W (cm)	H (cm)	Lts	☐	Bar Code
651425	25	19	5,50	2,30	4/12	8411922204070
651430	30	22	6	3,50	4/12	8411922204087
651435	35	26	6,50	5,40	4/12	8411922204094
651440	40	28	7	7,50	4/8	8411922204377

Rustidera Bistrot

Bistrot Roast Pan
Plat à Rôtir Bistrot
Bratreine Bistrot
Tabuleiro Bistrot



- **Acero Inoxidable**
- **Asas Metálicas**
- **Asa Abatible**
- Stainless Steel
- Metallic Handles
- Folding Handle



ref.	L (cm)	W (cm)	H (cm)	Lts	☐	Bar Code
651830	31	24	5,50	3,20	4/12	8411922209600
651835	38	27	6,50	5,10	6	8411922209617
651840	43	31	7	7,40	6	8411922209624
651845	48	34	7	9,30	4	8411922209631
651850	53	38	7,50	12,40	4	8411922209648
651860	63	45	7,50	18,40	4	8411922209662

Rustidera

Roast Pan
Plat à Rôtir
Bratreine
Tabuleiro



- **Acero Inoxidable 18%**
- Stainless Steel 18%



ref.	L (cm)	W (cm)	H (cm)	☐	Bar Code
652735	35	26	5,70	2/6	8411922451771
652738	38	29	6,20	2/6	8411922451788



Rustidera con Asas Metálicas Moka

Moka Roast Pan with Metallic Handles
 Plat à Rôtir avec Anses Métalliques Moka
 Bratreine mit Metallgriffen Moka
 Tabuleiro com Pegas Metálicas Moka



- Chapa de Acero
- Recubrimiento Antiadherente
- Extrafuerte
- Steel Plate
- Non-Stick Coating
- Extraheavy



ref.	L (cm)	W (cm)	H (cm)	📦	Bar Code
828340	40	28	6,80	6	8411922093865

Rustidera Moka

Moka Roast Pan
 Plat à Rôtir Moka
 Bratreine Moka
 Tabuleiro Moka



- Chapa de Acero
- Recubrimiento Antiadherente
- Steel Plate
- Non-Stick Coating



ref.	L (cm)	W (cm)	H (cm)	📦	Bar Code
822028	28	18	4	6/36	8411922071290
822033	32	22	5	6/24	8411922423792
822037	36	24	5	6/24	8411922423808
822040	40	27	5	6/24	8411922207316

Rustidera con Parrilla Moka

Moka Roast Pan with Grill
 Plat à Rôtir avec Grill Moka
 Bratreine mit Grill Moka
 Tabuleiro com Grelha Moka



- Chapa de Acero
- Recubrimiento Antiadherente
- Steel Plate
- Non-Stick Coating



ref.	L (cm)	W (cm)	H (cm)	📦	Bar Code
828637	37,50	27	4,50	6/12	8411922433661

Fuente para Horno Moka

Moka Roast Pan
 Plat à Rôtir Moka
 Bratreine Moka
 Tabuleiro Moka



- Chapa de Acero
- Recubrimiento Antiadherente
- Steel Plate
- Non-Stick Coating



ref.	L (cm)	W (cm)	H (cm)	Lts	📦	Bar Code
822236	36	25	6	4,80	10	8411922206852
822239	40	25	6	5	10	8411922202465

Chocolate.



Chocolate.

Moldes Rígidos 3D.



Molde Zapato 3D

3D Shoe Mold
Moule Chaussure 3D
3D-Schuhform
Molde Sapato 3D

- Ecozen
- Magnético
- Ecozen
- Magnetic



ref.	L (cm)	H (cm)		Bar Code
792600	16	13	1/6/24	8411922092141
792650	12	10	1/6/36	8411922434002

Molde Copa de Chocolate 3D

Chocolate Cup 3D Mold
 Moule Coupe à Chocolat 3D
 3D-Schokoladen-Tassenform
 Molde de Copo de Chocolate 3D

- Ecozen
- Magnético
- Ecozen
- Magnetic



ref.	∅ (cm)	H (cm)	📦	Bar Code
789750	10	6	6/72	8411922449945

Molde Chocobar

Chocobar Mold
 Moule Chocobar
 Chocobar Förmchen
 Molde Chocobar

- Tritán
- Tritan



ref.	L (cm)	W (cm)	📦	Bar Code
750900	27	9	1/6/72	8411922441574

Molde Bolso 3D

3D Handbag Mold
 Moule Sac 3D
 Handtasche Form 3D
 Molde Saco 3D

- Policarbonato
- Magnético
- Polycarbonate
- Magnetic



ref.	L (cm)	W (cm)	H (cm)	📦	Bar Code
740700	22	14	17	1/6/24	8411922435085

Molde Abeto 3D

3D Fir Mold
 Moule Sapin 3D
 3D-Tannenform
 Forma de Abeto 3D

- SAN
- SAN



ref.	∅ (cm)	H (cm)	📦	Bar Code
850000	11	14,50	1/6/24	8411922458589

Molde Ginger 3D

Ginger 3D Mold
 Moule à Ginger 3D
 3D-Ingwer-Förmchen
 Molde de Gengibre 3D

- Policarbonato
- Magnético
- Polycarbonate
- Magnetic



ref.	H (cm)	📦	Bar Code
746200	20	1/6	8411922436839

Molde Corazón 3D Mini

Mini 3D Heart Mold
 Moule à Coeur 3D Mini
 Mini 3D Herzform
 Forma Coração 3D Mini

- Policarbonato
- Magnético
- Polycarbonate
- Magnetic



ref.	W (cm)	H (cm)	📦	Bar Code
798800	9	8,50	1/6/36	8411922434019

Set 3 Moldes Huevo de Pascua 3D

Set 3 Easter Egg Mold 3D
Set 3 Moule Oeuf de Pâques 3D
Set 3 3D-Ostereier-Formen
Jogo 3 Moldes de Ovos de Páscoa 3D



- SAN
- SAN



ref.	L (cm)	W (cm)		Bar Code
776210	16+11+8	12+9+6	1/6/36	8411922447095

Molde para Caja Corazón de Chocolate

Chocolate Heart Box Mold
Moule pour Boîte en Chocolat
Schokoladen-Herz-Box-Form
Forma para Caixa de Coração de Chocolate



- SAN
- SAN



ref.	L (cm)	W (cm)	H (cm)		Bar Code
776310	11	11	7	1/6/48	8411922447125

Molde Esfera 3D

3D Sphere Mold
Moule Sphère 3D
3D Kugel Form
Forma Esfera 3D

- Ecozen
- Magnético
- Ecozen
- Magnetic



ref.	∅ (cm)		Bar Code
828914	14	1/6/12	8411922441390
828918	18	1/6	8411922438567

Moldes Tortuga 3D

3D Turtle Molds
Moules de Tortues 3D
3D-Schildkröten-Formen
Moldes Tartaruga 3D



- PET
- PET



ref.	L (cm)	W (cm)		Bar Code
796300	15	10	6/36	8411922093759

Molde à Bûche Tronco

Yule Log Cake Mold
Moule à Bûche
Bûcheform für Weihnachtskuchen
Forma para Bolo de Natal Tronco



- Polietileno
- Polyethylene



ref.	L (cm)	W (cm)	H (cm)		Bar Code
850200	30	9,50	6,50	1/6	8411922458602

Set 3 Moldes Huevos de Pascua

Set 3 Easter Egg Molds
Jeu 3 Moules à Oeufs de Pâques
Set 3 Ostereier-Formen
Jogo 3 Formas Ovos de Páscoa



- PET
- PET



ref.	L (cm)		Bar Code
791800	6+7+8	6/48	8411922090871



Cónico Rizado

Conical Fluted
Conique Cannelé
Konisch Gewölbt
Cónico Curvo



ref.	L (cm)	W (cm)	H (cm)		Bar Code
799400	27	14	2,50	1/6/36	8411922434224

Rectangular

Rectangular
Rectangulaire
Rechteckige
Retangular



ref.	L (cm)	W (cm)	H (cm)		Bar Code
799404	27	14	2,50	1/6/36	8411922434262

Cuadrado

Square
Carré
Quadratische
Quadrado



ref.	L (cm)	W (cm)	H (cm)		Bar Code
799401	27	14	2,50	1/6/36	8411922434231

Cucharillas

Teaspoon
Cuillère
Löffel
Colheres



ref.	L (cm)	W (cm)	H (cm)		Bar Code
799402	27	14	2,50	1/6/36	8411922434248

Semicircular

Semicircular
Semi-Circulaire
Halbrunde
Semicircular



ref.	L (cm)	W (cm)	H (cm)		Bar Code
799403	27	14	2,50	1/6/36	8411922434255



Chocolate.

Moldes Bombón Magnéticos Profesionales.

POLICARBONATO. ACERO INOXIDABLE
POLYCARBONATE. STAINLESS STEEL
POLYCARBONATE. ACIER INOXYDABLE
POLYCARBONATE. ROSTFREIER STAHL
POLICARBONATO. AÇO INOXIDÁVEL



Magnético Rectangular

Magnetic Rectangular
Magnétique Rectangulaire
Magnetisch Rechteckig
Retangular magnético



ref.	L (cm)	W (cm)	H (cm)		Bar Code
799304	27	14	2,50	1/6/36	8411922434200

Magnético Redondo Rizado

Magnetic Round Curly
Boucles rondes magnétiques
Magnetisch Rund Lockig
Cacheado redondo magnético



ref.	L (cm)	W (cm)	H (cm)		Bar Code
799305	27	14	2,50	1/6/36	8411922434217

Magnético Lágrima

Magnetic Teardrop
Perle magnétique
Magnetische Teardrop
Teardrop magnético



ref.	L (cm)	W (cm)	H (cm)		Bar Code
799300	27	14	2,50	1/6/36	8411922434163

Magnético Corazón

Magnetic Heart
Magnétique Coeur
Magnetische Herz
Magnético Coração



ref.	L (cm)	W (cm)	H (cm)		Bar Code
799302	27	14	2,50	1/6/36	8411922434187

Chocolate.

Moldes Flexibles.

SILICONA
SILICONE
SILICONE
SILIKON
SILICONE



Molde Bombón Marihuana

Cannabis Chocolate Pan
Moule Praliné Cannabis
Marihuana-Bonbonform
Forma Bombom Marijuana



ref.	L (cm)	W (cm)	H (cm)		Bar Code
860314	21	10	2,50	6/144	8411922455991



Molde Bombón Christmas

Christmas Chocolate Pan
Moule Praliné Noël
Weihnachten-Bonbonform
Forma Bombom Natal



ref.	L (cm)	W (cm)	H (cm)		Bar Code
860312	21	10,50	2,50	6/24	8411922088281

Molde Bombón San Valentín

Valentine's Day Chocolate Pan
Moule Praliné Saint-Valentin
Valentinstag-Bonbonform
Forma Bombom São Valentim



ref.	L (cm)	W (cm)	H (cm)		Bar Code
860311	21	10,50	2,50	6/24	8411922088274

Molde Bombón Corazón

Heart Chocolate Pan
Moule Praliné Coeur
Herz-Bonbonform
Forma Bombom Coração



ref.	L (cm)	W (cm)	H (cm)	ml		Bar Code
860301	21	10	2,50	10	6/48	8411922076592

Molde Bombón Mar

Sea Chocolate Pan
Moule Praliné Mer
Meer-Bonbonform
Forma Bombom Mar



ref.	L (cm)	W (cm)	H (cm)	ml		Bar Code
860307	21	10	2,50	10	6/48	8411922083422

Molde Bombón Diam

Diam Chocolate Pan
Moule Praliné Diam
Diam-Bonbonform
Forma Bombom Diam



ref.	L (cm)	W (cm)	H (cm)	ml		Bar Code
860303	21	10	2,50	10	6/48	8411922076615

Molde Bombón Hojas

Leaves Chocolate Pan
Moule Praliné Feuilles
Blätter-Bonbonform
Forma Bombom Folhas



ref.	L (cm)	W (cm)	H (cm)	ml		Bar Code
860305	21	10	2,50	10	6/48	8411922078169

Molde 4 Minitabletas

4 Mini Chocolate Bars Mold
Moule 4 Mini-Tablettes
Form 4 Schokotäfelchen
Forma 4 Mini Tabletes



ref.	L (cm)	W (cm)	H (cm)		Bar Code
850300	18,50	9,50	1	6/72	8411922458619

Molde Tableta de Chocolate 15 Onzas

Chocolate Bat Mold 15 Ounces
Moule à Chocolat 15 onces
Schokoladentafelform 15 Unzen
Forma Tablete de Chocolate 15 Onças



ref.	L (cm)	W (cm)	H (cm)		Bar Code
850310	18,50	9,50	1	6/72	8411922458626

Molde Tableta de Chocolate

Chocolate Bar Mold
Moule Tablette de Chocolat
Schokoladentafelform
Forma Tablete de Chocolate



ref.	L (cm)	W (cm)	H (cm)		Bar Code
860500	18,50	9,50	1	6/24	8411922087253

Molde Bombón Sardinas

Sardines Chocolate Pan
Moule Praliné Sardines
Sardinen-Bonbonform
Forma Bombome Sardinhas



ref.	L (cm)	W (cm)	H (cm)		Bar Code
860315	22,50	10,50	1	6/72	8411922458640

Molde Tableta de Chocolate Piramide

Pyramid Chocolate Bar Mold
Moule à Chocolat Pyramide
Pyramide Schokoladentafelform
Forma Tablete de Chocolate Pirâmide



- **Silicona**
- **Incluye Receta**
- Silicone
- Includes Recipe



ref.	L (cm)	W (cm)	H (cm)		Bar Code
850320	18,20	9	1	6/72	8411922458633

Chocolate.

Accesorios.

Set de Utensilios para Chokolatinas

Chocolate Utensils Set
Jeu Ustensiles pour Pralinés
Utensilienset für Schokoladenkuchen
Conjunto de Utensílios para Chokolatinas



ref.	L (cm)		Bar Code
788000	20	6/72	8411922088106

Cortador en Virutas con Tapa para Queso y Chocolate "La Girolle"

"La Girolle" Cheese and Chocolate Scraper
Découpeur de Fromage et Chocolat "La Girolle"
"La Girolle" Käse- und Schokoladenchipausstecher
Cortador de Queijo e Chocolate "La Girolle"



ref.	Ø (cm)		Bar Code
788100	22	1/6	8411922088137

Cazo Baño María

Double-Wall Boiler
Casserole Bain Marie
Stielkasserolle für Wasserbad
Cazo Banho Maria

- **Acero Inoxidable**
- **Mango de Baquelita**
- Stainless Steel
- Bakelite Handle

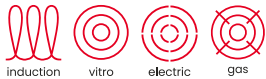

ref.	∅ (cm)	H (cm)	∅	Bar Code
774016	16	1/6	1/6	8411922079364

Cazo Baño María con Tapa

Double-Wall Boiler with Lid
Casserole Bain Marie avec Couvercle
Stielkasserolle für Wasserbad mit Deckel
Cazo Banho Maria com Tampa

- **Acero Inoxidable**
- **Mango de Baquelita**
- **Soft Touch**
- **Tapa de Cristal**
- Stainless Steel
- Bakelite Handle
- Soft Touch
- Glass Lid



ref.	∅ (cm)	H (cm)	∅	Bar Code
741316	16	9	1/6	8411922457957

Bol Semiesférico

Semispherical Bowl
Bol Semi-Sphérique
Halbkugelige Schale
Tigela Semi-Esférica

- **Acero Inoxidable**
- Stainless Steel



ref.	∅ (cm)	H (cm)	Lts	∅	Bar Code
730420	20	10	2	6/12	8411922448191

Termómetro Espátula para Chocolate

Spatula Thermometer for Chocolate
Thermomètre Spatule pour Chocolat
Spachtelthermometer für Schokolade
Termómetro Espátula para Chocolate

- **Silicona**
- **Graduación 0,1°C**
- Silicone
- Graduation 0.1°C



ref.	L (cm)	∅	Bar Code
790920	32	6/72	8411922439670

Termómetro para Azúcar

Sugar Thermometer
Thermomètre à Sucre
Zucker-Thermometer
Termómetro para Açúcar

- **Vidrio**
- **Acero Inoxidable**
- **Pantalla sin mercurio**
- Glass
- Stainless Steel
- Mercury free screen



ref.	L (cm)	∅	Bar Code
776700	30	6/24	8411922087932

Termómetro Digital

Digital Thermometer
Thermomètre Numérique
Digitales Thermometer
Termómetro Digital

- **Plástico**
- Plastic

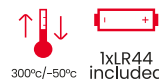

ref.	L (cm)	∅	Bar Code
790910	20	6/48	8411922090598

Termómetro Espátula Digital

Digital Spatula Thermometer
 Thermomètre Spatule Numérique
 Digitales Spachtelthermometer
 Termómetro Espátula Digital



- **Silicona**
- Silicone

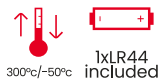

300°C/-50°C 1xLR44 included

ref.	L (cm)		Bar Code
790900	25	6/48	8411922090581

Turrón.

Molde Turrón de Chocolate

Chocolate Nougat Mold
 Moule Touron au Chocolat
 Schokoladennougat-Form
 Forma de Torrao de Chocolate



- **Silicona**
- Silicone



ref.	L (cm)	W (cm)	H (cm)	Lts		Bar Code
860400	20	10	2,50	0,30	6/36	8411922084252

Set 2 Cajas para Turrón Casero

2 Boxes for Homemade Nougat (Turrón)
 2 Boîtes pour Nougat
 2 Kisten für Hausgemachtes Turrón als Set
 Jogo de 2 Caixas para Torrao Caseiro



- **Madera**
- **Para proteger y transportar**
- Wood
- To protect and to take away

ref.	L (cm)	W (cm)	H (cm)		Bar Code
686500	23	10	4	4/16	8411922459234



Estuche para Turrón

Nougat Box
Étui pour Tournon
Nougatbox
Estojo para Torrão



- **Cartón**
- **Desechable**
- Cardboard
- Disposable

ref.	L (cm)	W (cm)	H (cm)		Bar Code
799100	22	10	2,50	12/72	8411922434132



Molde Turrón de Almendras

Almond Nougat Mold
Moule Nougat d'Amande
Mandel-Nougat-Förmchen
Forma de Torrão de Amêndoas

- **Acero Inoxidable**
- Stainless Steel
- Includes Recipe



ref.	L (cm)	W (cm)	H (cm)		Bar Code
753100	22	9	3	1/6/36	8411922084269





Set 2 Moldes Turrón Porciones

Set 2 Nougat Molds Portions
Jeu 2 Moules Tournon Portions
Set 2 Nougatformen Portionen
Jogo 2 Formas de Torrão Porções



ref.	L (cm)	W (cm)	📦	Bar Code
793502	23	10,50	6/72	8411922453645

Set 2 Moldes Turrón Estrecho-Doble

Set 2 Nougat Mold Narrow-Double
Jeu 2 Moules Tournon Étroit-Double
Set 2 Nougatformen Schmal-Doppelt
Jogo 2 Formas de Torrão Estreito-Duplo



ref.	L (cm)	W (cm)	📦	Bar Code
793503	23	13,50	6/72	8411922453652

Set 2 Moldes Turrón (Tronco + Onzas)

Set 2 Nougat Molds (Trunk + Ounces)
Jeu 2 Moules Tournon (Tronc + Carrés)
Set 2 Nougatformen (Stamm + Unzen)
Jogo 2 Formas de Torrão (Tronco + Onças)



ref.	L (cm)	W (cm)	H (cm)	📦	Bar Code
793501	23	10	2	6/72	8411922092592

Set 2 Moldes Turrón (Liso + Rombos)

Set 2 Nougat Molds (Plain + Diamonds)
Jeu 2 Moules Tournon (Lisse + Losanges)
Set 2 Nougatformen (Glatt + Rhombus)
Jogo 2 Formas de Torrão (Liso + Losangos)



ref.	L (cm)	W (cm)	H (cm)	📦	Bar Code
793500	23	10	2	6/72	8411922092585

Helados.



Molde 2 Helados 3D Été

3D Été 2 Ice Cream Mold

Moule Glaces 3D Été

2 Eiscreme-Förmchen 3D Été

Forma para 2 Gelados 3D Été

- **Silicona**
- **Incluye 12 palitos reutilizables**
- Silicone
- Includes 12 reusable sticks



ref.	L (cm)	ml		Bar Code
783950	10,50	2x35	1/6/72	8411922454758

Set 6 Vasos de Helado + 6 Cucharitas

Set 6 Ice Cream Glasses + 6 Spoons
 Jeu 6 Verres à Glace + 6 Petites Cuillères
 Set 6 Eisbechern + 6 Löffeln
 Jogo 6 Taças de Gelado + 6 Colheres

- **Cartón**
- **Plástico**
- **Desechable**
- Cardboard
- Plastic
- Disposable



ref.	Lts		Bar Code
795400	0,16	6/72	8411922093636

Molde para Helados

Ice Cream Molds
 Moule pour Glaces
 Eiscreme-Förmchen
 Forma para Gelados

- **Plástico**
- **Incluye Receta**
- Plastic
- Includes Recipe



ref.	L (cm)	H (cm)		Bar Code
783400	15	10	6/48	8411922083521

Molde para 8 Helados Cónicos

8 Conical Ice Cream Mold
 Moule pour 8 Glaces Coniques
 Form für 8 Konische Eiscremen
 Forma para 8 Gelados Cónicos

- **Plástico**
- **Incluye Receta**
- Plastic
- Includes Recipe



ref.	L (cm)	H (cm)	ml		Bar Code
783450	20	10	50	6/36	8411922090536

Moldes Sorbete (2 uds.)

Sorbet Molds
 Moule Sorbet
 Sorbet-Formen
 Forma Sorvete

- **Silicona**
- **Incluye Receta**
- Silicone
- Includes Recipe



ref.	L (cm)		Bar Code
754000	20	6/36	8411922086317

Dispensador para Helado Confort

Confort Ice Cream Scoop
 Cuillère à Glace Confort
 Eiscreme-Spender Confort
 Dispensador de Gelados Confort

- **Aluminio**
- Aluminium



ref.	L (cm)		Bar Code
795700	17	6/60	8411922093681

Dispensador para Helado Function

Function Ice Cream Scoop
 Cuillère à Glace Function
 Eiscreme-Spender Function
 Dispensador de Gelados Function

- **Aluminio**
- Aluminium



ref.	L (cm)		Bar Code
795800	20	6/36	8411922093698

Dispensador para Helado Ergonomic

Ergonomic Ice Cream Scoop
Cuillère de Glace Ergonomic
Eiscreme-Spender Ergonomic
Dispensador de Gelado Ergonomic



- Acero Inoxidable
- Plástico
- Soft Touch
- Stainless Steel
- Plastic
- Soft Touch

ref.	Ø (cm)	L (cm)	📦	Bar Code
763740	4	22	6/48	8411922449167
763760	6	24	6/48	8411922449181

Racionador para Helado

Ice Cream Scoop
Cuillère à Glace
Eiscreme Spender
Dispensador de Gelados



- Acero Inoxidable 18/10
- Stainless Steel 18/10

ref.	Ø (cm)	📦	Bar Code
764140	4	6/72	8411922434095
764145	4,50	6/72	8411922434101
764150	2,20	6/72	8411922203790
764155	5,50	6/72	8411922434118
764160	6	6/72	8411922434125

Moldes Varios.

Set 3 Moldes para Pancakes

Set 3 Pancake Molds
Jeu 3 Moules pour Pancakes
Set 3 Pfannkuchenformen
Jogo 3 Formas para Panquecas

- Silicona
- Silicone



ref.	L (cm)	W (cm)	H (cm)	📦	Bar Code
756950	14+12+13	10+11+8	3	6/72	8411922456561



Set 2 Moldes Gominolas Animales y Frutas

Set 2 Gummy Molds Animals and Fruits
Jeu 2 Moules pour Bonbons Gelifies Animaux et Fruits
Set 2 Gummiformen Tiere und Früchte
Jogo 2 Formas para Gomas Animais e Frutas

- Silicona
- 8 figuras diferentes
- Silicone
- 8 different shapes



ref.	L (cm)	W (cm)	📦	Bar Code
850100	23	18	6/48	8411922458596

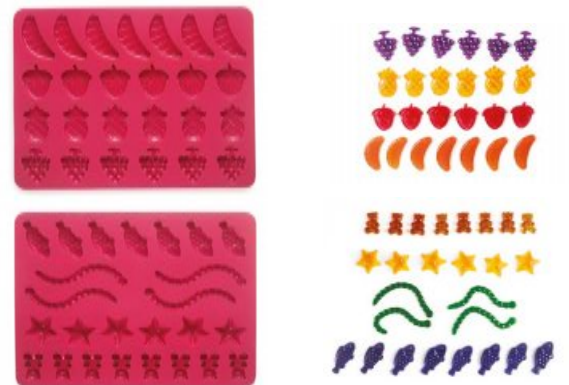

Molde Osito

Teddy Bear Mold
Moule à Ourson
Teddybär-Förmchen
Forma Ursinho



- **Silicona**
- Silicone



ref.	L (cm)	W (cm)	H (cm)		Bar Code
871600	26	24	5,50	1/6/24	8411922089714

Molde para Cake Pops

Cake Pops Mold
Moule pour Cake Pops
Cake Pop Förmchen
Forma para Cake Pops



- **Silicona**
- Silicone



ref.	L (cm)	W (cm)		Bar Code
872000	30	14	6/24	8411922089752

Palos para Cakepops

Sticks for Cakepops
Bâtons pour Cakepops
Cakepops Stäbchen
Palitos para Cakepops



- **Papel**
- Paper

ref.	L (cm)	W (mm)		Bar Code	
786510	10	3,50	6/108	8411922092318	100 uds
786511	11,50	4	6/144	8411922092325	50 uds
786515	15	3,50	6/144	8411922092332	35 uds

Molde Pushup Cake

Push Up Cake Mold
Moule Push Up Cake
Push Up Cake Formen
Forma Push Up Cake



- **Plástico**
- Plastic



ref.	L (cm)	Ø (cm)		Bar Code
792900	9,50	5	6/24	8411922092448

Set 6 Moldes para Gelatina

Set 6 Jelly Molds
Jeu 6 Moules à Gélatine
Set 6 Gelee-Förmchen
Jogo 6 Formas para Gelatina



- **Plástico**
- Plastic



ref.	Ø (cm)	H (cm)		Bar Code
756500	7,30	6,10	6/24	8411922209242

Set 4 Flaneros con Tapa Apilables

Set 4 Stackable Creme Caramel Molds with Lid
Jeu 4 Moules Crème Caramel avec Couvercle Empilables
Set 4 Puddingform mit Deckel Stapelbar
Jogo 4 Formas para Pudim Flan com Tampa Empilháveis



- **Silicona**
- **Plástico**
- Silicone
- Plastic



ref.	Ø (cm)	H (cm)		Bar Code
871800	8	5,50	6/36	8411922089738

Molde Mini Panna Cotta

Mini Panna Cotta Mould
Moule à Panna Cotta Mini
Mini Panna Cotta Form
Forma para Mini Panna Cotta

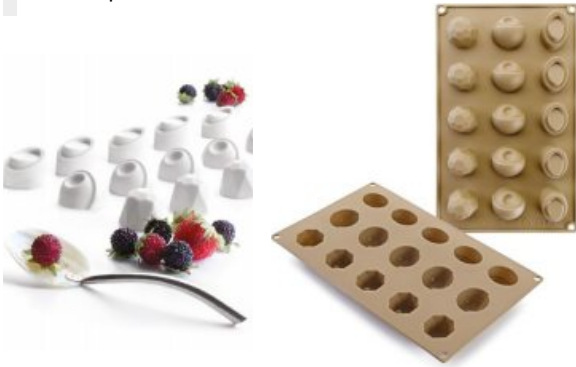

- **Silicona**
- Silicone



ref.	L (cm)	W (cm)	H (cm)	📦	Bar Code
871900	30	17	6/36	6/36	8411922089745

Buñolera Doble Inox

Double Stainless Steel Fritter Ladle
Louche à Beignets Double Inox
Doppel-Schöpfkelle für Krapfen aus Edelstahl
Colher para Sonhos Dupla Inox



- **Acero Inoxidable**
- Stainless Steel



ref.	∅ (cm)	H (cm)	📦	Bar Code
712150	7,50	2	6/24	8411922087901

Buñolera Simple Inox

Single Stainless Steel Fritter Ladle
Louche à Beignets Simple Inox
Schöpfkelle für Krapfen aus Edelstahl
Colher para Sonhos Individual Inox



- **Acero Inoxidable**
- Stainless Steel

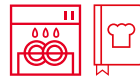

ref.	∅ (cm)	H (cm)	📦	Bar Code
712100	7,50	2	6/72	8411922072556

Molde Florón Pequeño

Small Rossete Mold
Moule à Rosace Petit
Kleine Blumen Backform
Forma para Rosácea Pequena



- **Acero Inoxidable**
- Stainless Steel



ref.	∅ (cm)	H (cm)	📦	Bar Code
774356	6,20	4	6/12	8411922084894

Molde Florón Grande

Large Rossete Mold
Moule à Rosace Grand
Große Blumen Backform
Forma para Rosácea Grande



- **Acero Inoxidable**
- Stainless Steel



ref.	L (cm)	∅ (cm)	H (cm)	📦	Bar Code
774300	38	9	3	6/12	8411922079487
774350	37	9	3	6/12	8411922082685

Set Moldes Rosetón

Set Rose Molds
Jeu Moules Rosaces
Blumenförmchen Set
Jogo Formas Rosácea

- Aluminio
- Madera
- Aluminium
- Wood



ref.	L (cm)	Ø (cm)	📦	Bar Code
787600	25	7	12/48	8411922088052

Molde Florón Corazón

Rosete Heart Mold
Moule à Rosace Coeur
Herzförmige Blumen Backform
Forma para Rosácea Coração

- Acero Inoxidable
- Stainless Steel



ref.	L (cm)	Ø (cm)	📦	Bar Code
774610	39,50	10	6/12	8411922445060

Molde para Gofres

Waffle Mold
Moule à Gaufres
Waffelform
Molde para Waffles

- Aluminio Antiadherente
- Aluminum Non-Stick Coating



ref.	L (cm)	W (cm)	📦	Bar Code
771100	22	13	1/12	8411922078060

Set 6 Moldes con Expulsor para Mantequilla y Pastas

Set 6 Molds with Ejector for Butter and Biscuits
Set 6 Moules avec Pousoir pour Beurre et Pâtes
Set 6 Formen mit Auswerfer für Butter und Kekse
Jogo 6 Formas com Expulsor para Manteiga e Biscoitos



- Acero Inoxidable
- Stainless Steel

ref.	📦	Bar Code
719800	6/48	8411922079890

Molde Huevo Cuadrado

Square Egg Mold
Moule Oeuf Carré
Quadratische Eierform
Molde de Ovo Quadrado

- Plástico
- Plastic



ref.	L (cm)	W (cm)	📦	Bar Code
776500	9	7	12/144	8411922087857

Molde Empanadillas Inox

Stainless Steel Dumpling Maker
Moule Chaussons Inox
Edelstahl-Knödelmacher
Forma de Bolinhos Inox

- Acero Inoxidable
- Asas de Acero Inoxidable
- Stainless Steel
- Stainless Steel Handles



ref.	Ø (cm)	📦	Bar Code
773510	10	1/6/48	8411922078176
773512	12	1/6/36	8411922078183
773515	15	2/6/24	8411922475210

NEW

Molde Empanadillas Corazón

Heart Shaped Dumpling Maker
Moule Chaussons Coeur
Herzförmige Knödelmacher
Forma para Salgados Coração



- Plástico
- Plastic

ref.	W (cm)		Bar Code
787500	10	1/12/36	8411922088045

Set 4 Moldes Empanadillas

Set 4 Dumpling Molds
Jeu 4 Moules Chaussons
Set 4 Knödelformen
Jogo 4 Formas para Salgados



- Plástico
- Plastic

ref.	L (cm)		Bar Code
707700	6+8+10+13	1/12/24	8411922074895

Kit para Croquetas Eco

Eco Croquettes Kit
Kit pour Croquettes Eco
Set für Kroketten Eco
Kit para Croquetas Eco



- Plástico
- Incluye Receta
- Plastic
- Includes Recipe

ref.	L (cm)	W (cm)	
781810	55	24	

Kit para Croquetas

Croquettes Kit
Kit pour Croquettes
Set für Kroketten
Kit para Croquetas



- Acero Inoxidable
- Incluye Receta
- Stainless Steel
- Includes Recipe

ref.	L (cm)	W (mm)		Bar Code
777000	55	24	6/24	8411922072518
777000E	55	24	12	8411922072518

Máquina para Croquetas

Croquette Machine
Machine à Croquettes
Krokettenmacher
Maquina para Elaborar Croquetas



- Plástico
- Fabricado en EU
- Gran cantidad de croquetas de forma rápida
- Plastic
- Manufactured in EU
- Lots of croquettes quickly



ref.	L (cm)	W (cm)	H (cm)		Bar Code
706250	28	15	11,50	1	8411922456394

Sopletes.



Soplete Elegance

Elegance Torch
Chalumeau Elegance
Küchenbrenner Elegance
Maçarico Elegance

- Metálico
- Plástico
- Temperatura máxima 1300°C
- Metallic
- Plastic
- Max. Temperature 1300°C



70-100 min

ref.	Lts		Bar Code
738900	0,028	1/6/24	8411922093469

Soplete Gourmet Clásica

Clasica Gourmet Torch
Chalumeau Gourmet Clasica
Gourmet Schweißbrenner Clasica
Maçarico Gourmet Clásica

- Metálico
- Plástico
- Temperatura máxima 1300°C
- Metallic
- Plastic
- Max. Temperature 1300°C



70-100 min

ref.	Lts		Bar Code
704400	0,028	1/6/18	8411922072341

Soplete Gourmet Profesional

Professional Gourmet Torch
Chalumeau Gourmet Professionnel
Gourmet Schweißbrenner Professionell
Maçarico Gourmet Profissional

- **Metálico**
- **Plástico**
- **Profesional**
- **Temperatura máxima 1300°C**
- Metallic
- Plastic
- Professional
- Max. Temperature 1300°C



50-120 min

ref.	Lts		Bar Code
704500	0,063	1/6/18	8411922072358

Soplete Gourmet Luxe

Luxe Gourmet Torch
Chalumeau Gourmet Luxe
Gourmet Schweißbrenner Luxe
Maçarico Gourmet Luxe

- **Metálico**
- **Plástico**
- **Temperatura máxima 1300°C**
- Metallic
- Plastic
- Max. Temperature 1300°C



70-100 min

ref.	Lts		Bar Code
704450	0,028	1/6/18	8411922079371

Soplete Mini Handy

Handy Mini Torch
Chalumeau Mini Handy
Mini-Küchenbrenner Handy
Maçarico Mini Handy

- **Plástico**
- **Metálico**
- **Temperatura máxima 1300°C**
- Plastic
- Metallic
- Max. Temperature 1300°C



25-40 min

ref.	L (cm)	Lts		Bar Code
793400	12	0,01	6/24	8411922092493

Cabezal Soplete Profesional

Professional Torch Head
Tête Chalumeau Professionnel
Profi Kopfteil Küchenbrenner
Boquilha de Maçarico de Cozinha Profissional

- **Profesional**
- **Sistema a rosca · Temperatura máxima 1450°C**
- Professional
- Screw system · Max. Temperature 1450°C



180-240 min

ref.	L (cm)		Bar Code
786600	16,50	1/6/24	8411922087550

Recambio de Gas para Cabezal Soplete

Gas Refill for Torch Head
Recharge de Gaz pour Tête Chalumeau
Gasnachfüllung für Lötlampe Kopf
Recarga de Gás para Cabeça de Maçarico



- **Sistema a rosca · Butano + propano**
- Screw system · Butane + propane



ref.	Lts		Bar Code
727060	0,60	6/24	8411922087420

Adaptador Cabezal Soplete

Torch Head Adapter
Adaptateur pour Tête de Chalumeau
Adapter Kopfteil Küchenbrenner
Adaptador para Boquilha de Maçarico



- **Apto para cabezales con válvula EN417**
- **Adapta soplete rosca a botella sistema clip**
- Adaptor for torches with EN417 valve
- From screw system torch to clip system bottle

ref.	∅ (cm)		Bar Code
684300	4	6/36	8411922457414

Gas Butano Azul Universal

Universal Blue Butane Gas
Gaz Butane Bleu Universel
Universal-Butangas Blau
Gás Butano Azul Universal



ref.	Lts		Bar Code
727020	0,20	6	8411922083767

Queimador Graduable

Adjustable Burner
Brûleur Régable
Einstellbarer Brenner
Queimador Graduável



- Acero Inoxidable
- Temperatura máxima 1300°C
- Stainless Steel
- Max. Temperature 1300°C



60-80 min

ref.	∅ (cm)	H (cm)	Lts		Bar Code
704700	8,50	8	0,027	1/6/24	8411922072372

Soporte para Quemador

Support for Burner
Support pour Brûleur
Unterstützung für Brenner
Suporte de Queimador



- Acero Inoxidable
- Stainless Steel



ref.	∅ (cm)	H (cm)		Bar Code
704800	16	11	1/6	8411922072389

Aros para Emplatar.

ACERO INOXIDABLE
STAINLESS STEEL
ACIER INOXYDABLE
ROSTFREIER STAHL
AÇO INOXIDÁVEL



Aro Redondo H 4,5cm

Round Pastry Ring H 4,5cm
Cercle Rond H 4,5cm
Runder Gebäckring H 4,5cm
Aro Redondo H 4,5cm



ref.	∅ (cm)	H (cm)		Bar Code
716004	4	4,50	6/72	8411922078732
716005	5	4,50	6/72	8411922078749
716006	6	4,50	6/72	8411922069969
716007	7	4,50	6/72	8411922069976
716008	8	4,50	6/72	8411922069983
716009	9	4,50	6/72	8411922069990
716010	10	4,50	6/72	8411922070002
716012	12	4,50	6/72	8411922070019
716020	20	4,50	6/48	8411922070033
716024	24	4,50	6/36	8411922070040
716050	7+8+10	4,50	6/36	8411922073119

Aro Redondo H 6cm

Round Pastry Ring H 6cm
Cercle Rond H 6cm
Runder Gebäckring H 6cm
Aro Redondo H 6cm



ref.	∅ (cm)	H (cm)	📦	Bar Code
716106	6	6	6/72	8411922070057
716107	7	6	6/72	8411922070064
716108	8	6	6/72	8411922070071
716109	9	6	6/72	8411922070088
716110	10	6	6/72	8411922070095
716112	12	6	6/60	8411922070101

Aro Cuadrado

Square Pastry Ring
Cercle Carré
Quadratischer Gebäckring
Aro Quadrado



ref.	L (cm)	W (cm)	H (cm)	📦	Bar Code
716906	6	6	4,50	6/72	8411922076141
716908	8	8	4,50	6/72	8411922076165
716910	10	10	4,50	6/72	8411922076189

Aro Rectangular

Rectangular Pastry Ring
Cercle Rectangulaire
Rechteckiger Gebäckring
Aro Rectangular



ref.	L (cm)	W (cm)	H (cm)	📦	Bar Code
722708	8	5	4,50	6/72	8411922084825
722712	12	6	4,50	6/72	8411922080520

Aro Triángulo

Triangle Pastry Ring
Cercle Triangle
Dreieckiger Gebäckring
Aro Triangulo



ref.	∅ (cm)	H (cm)	📦	Bar Code
718508	8	4,50	6/72	8411922078800
718510	10	4,50	6/72	8411922078817

Aro Pez

Fish Pastry Ring
Cercle Poisson
Fisch Gebäckring
Aro de Peixe



ref.	L (cm)	W (cm)	H (cm)	📦	Bar Code
725712	12	7	4,50	6/72	8411922082722

Aro Estrella

Star Pastry Ring
Cercle Étoile
Stern Gebäckring
Aro Estrela



ref.	∅ (cm)	H (cm)	📦	Bar Code
718710	10	4,50	6/72	8411922078848

Aro Cuadrado Bombado

Bulging Square Pastry Ring
Cercle Carré Bombé
Gewölbtes Quadrat Gebäckring
Aro Quadrado Abaulado



ref.	L (cm)	W (cm)	H (cm)	📦	Bar Code
727908	8	8	4,50	6/72	8411922084856
727910	10	10	4,50	6/72	8411922084863

Aro Lauburu

Lauburu Pastry Ring
Cercle Lauburu
Lauburu Gebäckring
Aro Lauburu



ref.	∅ (cm)	H (cm)	📦	Bar Code
722310	10	4,50	6/72	8411922080131

Aro Champiñon

Mushroom Pastry Ring
Cercle Champignon
Pilz Gebäckring
Aro de Cogumelo



ref.	L (cm)	W (cm)	H (cm)	📦	Bar Code
727708	8	7	4,50	6/72	8411922084818

Set 3 Aros Redondos con Pisador

Round Pastry Rings with Pusher
Cercles Ronds avec Poussoir
Runde Gebäckringe mit Stößel
Aros Redondos com Pisador



ref.	∅ (cm)	📦	Bar Code
716090	7+8+10	1/6/24	8411922081831

Pisador para Aros Redondos

Round Pastry Ring Pusher
Poussoir Cercle Rond
Stampfer für Runder Gebäckring
Pisador para Aros Redondos



ref.	∅ (cm)	📦	Bar Code
718007	7	6/72	8411922078244

Set 3 Aros de Emplatar Nylon

Pastry Rings
Cercles à Servir
Gebäckringe
Aros de Servir



- Nylon
- Nylon



ref.	∅ (cm)	H (cm)	📦	Bar Code
752850	7+8+10	4,50	6/72	8411922084214

Rollo PVC Pastelería

PVC Pastry Roll
Rouleau à Pâtisserie PVC
PVC Gebäckrolle
Rolo PVC Pastelaria



ref.	L (cm)	H (cm)	📦	Bar Code
773602	200	4,50	1/6/24	8411922078534
773606	200	6	1/6/24	8411922436136
773608	200	10	1/6/24	8411922453386



Sifones y Cargas.

ALUMINIO

ALUMINIUM
ALUMINIUM
ALUMINIUM
ALUMÍNIO



LFGB



Sifón de Nata Blanco

White Cream Whipper
Siphon à Crème Blanche
Sahne-Siphon Weiß
Sifão de Natas Branco

- 2 boquillas
- 2 nozzles

ref.	Lts		Bar Code
750805	0,50	1/2/12	8411922070866



Sifón de Nata

Cream Whipper
Siphon à Crème
Sahne-Siphon
Sifão de Natas



- 2 boquillas
- 2 nozzles

ref.	Lts		Bar Code
750902	0,25	1/2/12	8411922070880
750905	0,50	1/2/12	8411922070897
750910	1	1/2/12	8411922070903

Cargas de Sifón de Nata N2O

N2O Cream Siphon Charges
Charges de Siphon à Crème N2O
Sahne-Siphon N2O-Ladungen
Cargas de Sifão de Natas N2O



ref.		Bar Code	
751000	1/5/30	8411922070910	10 uds
751050	1/16	8411922449938	24 uds

Sifones y
Cargas.

Recambios.

Set 2 Boquillas

Set of 2 Nozzles
Jeu 2 Douilles
Set mit 2 Düsen
Jogo 2 Boquilhas

ref.		Bar Code	
CNW0102	1	8411922073133	A

Adaptador para Boquilla

Nozzle Adapter
Adaptateur Douille
Düsenadapter
Adaptador para Boquilha

ref.		Bar Code	
CC02	1	8411922073140	B

Pistón

Piston
Piston
Kolben
Pistao

ref.		Bar Code	
CPA01	1	8411922073188	C

Protector entrada Gas Repuestos

Gas Inlet Protector
Protecteur Entrée Gaz
Gaseinlass Schutz
Protetor Entrada de Gas

ref.		Bar Code	
CCA01	1	8411922073157	D

Soporte de Cargas

Whipper Support
Support De Charges
Whipper-Unterstützung
Suporte de Cargas

ref.		Bar Code	
CH01	1	8411922073164	E

Junta de Goma

Rubber Gasket
Joint en Caoutchouc
Gummidichtung
Junta de Borracha

ref.		Bar Code	
CG02	1	8411922073171	F



Churreras.

Churrera-Máquina de Pastas (Estuche)

Churros Maker-Cookie Machine (Case)
Machine à Churros-Machine à Pâtes (Trousse)
Churrosmaschine-Keksmaschine (Koffer)
Churrera-Máquina de Massas (Caixa)



- **Aluminio**
- **8 boquillas · 13 Discos · Disco para churros rellenos**
- Aluminium
- 8 nozzles · 13 discs · Disc for filled churros



ref.	Lts	H (cm)		Bar Code
792300	0,20	22	1/6	8411922091830

Churrera a Rosca

Threaded Churro Maker
Machine à Churros Vissable
Churro-Schnecken Machine
Máquina de Fazer Churros



- **Plástico**
- **12 discos · 3 grosores de churros · Disco para churros rellenos · Gran capacidad**
- Plastic
- 12 discs · 3 thicknesses of churros · Disc for filled churros · Large capacity



ref.	∅ (cm)	H (cm)		Bar Code
687400	8,50	24	1/6/24	8411922459777



Churrera-Máquina de Pastas

Churros Maker-Cookie Machine
Machine à Churros-Machine à Pâtes
Churrosmaschine-Keksmaschine
Churrera-Máquina de Massas



- **Acero Inoxidable**
- **Plástico**
- Stainless Steel
- Plastic



ref.	L (cm)	W (cm)	☐	Bar Code
769500	25	12	1/6/24	8411922209730

Rosquilleras.



Rosquillera Inox

Stainless Steel Doughnut Maker
Machine à Beignets Inox
Krepfen-Maker Edelstahl
Aparelho da Fazer Rosquinhas
Inox



ref.	H (cm)	☉ (cm)	☐	Bar Code
734200	18	8,50	1/6/24	8411922087895

Rosquillera de Plástico

Plastic Doughnut Maker
Machine à Beignets Plastique
Plastik-Krepfen-Maker
Aparelho de Fazer Rosquinhas de
Plástico



ref.	☐	Bar Code
765100	1/12/36	8411922206357

Cortapastas.

Cortapastas.

Cortapastas Linzer.



Cortapastas Linzer Rizado

Fluted Linzer Dough Cutter
Emporte-Pièce Linzer Dentelé
Gekräuselter Linzer Ausstecher
Corta Massas Linzer Canelado



- **Acero Inoxidable**
- Stainless Steel



ref.	☉ (cm)	☐	Bar Code
774503	5	6/144	8411922079531

Set Cortapastas Linzer Navidad

Set Linzer Dough Cutters Christmas
Jeu Emporte-Pièces Linzer Noël
Set Linzer Ausstecher Weihnachten
Jogo Corta Massas Linzer Natal



ref.	∅ (cm)	📦	Bar Code
794200	5	12/72	8411922093407

Set Cortapastas Linzer Números

Set Linzer Dough Cutters Numbers
Jeu Emporte-Pièces Linzer Numéros
Set Linzer Ausstecher Zahlen
Jogo Corta Massas Linzer Números



ref.	∅ (cm)	📦	Bar Code
794201	5	12/72	8411922093414

Set Cortapastas Linzer Clásico

Set Linzer Dough Cutters Classic
Jeu Emporte-Pièces Linzer Clasic
Set Linzer Ausstecher Klassisch
Jogo Corta Massas Linzer clássico



ref.	∅ (cm)	📦	Bar Code
794202	5	12/72	8411922093421

Set 10 Cortapastas Linzer Navidad

Set 10 Christmas Linzer Dough Cutter
Jeu 10 Emporte-Pièce Linzer Noël
Set 10 Linzer Ausstecher Weihnacht
Jogo 10 Corta Massas Linzer Natal



ref.	📦	Bar Code
742500	1/6/48	8411922435481

Set 10 Cortapastas Linzer Baby

Set 10 Baby Linzer Dough Cutter
Jeu 10 Emporte-Pièce Linzer Baby
Set 10 Linzer Ausstecher Baby
Jogo 10 Corta Massas Linzer Baby



ref.	📦	Bar Code
742501	1/6/48	8411922435498



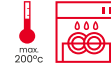

Cortamasas Redondo Liso (9 uds.)

Round Plain Dough Cutter
Emporte-Pièce Rond Lisse
Rund Flach Ausstecher
Corta Massas Redondo Liso



ref.	∅ (cm)		Bar Code
784201	2-10	1/6/36	8411922084580

Cortamasas Redondo Rizado (9 uds.)

Round Fluted Dough Cutter
Emporte-Pièce Rond Dentelé
Gelockter Runder Ausstecher
Corta Massas Redondo Canelado



ref.	∅ (cm)		Bar Code
784200	2-10	1/6/36	8411922084573

Cortamasas Cuadrado Rizado (9 uds.)

Square Fluted Dough Cutter
Emporte-Pièce Carré Dentelé
Gelockter Quadratisch Ausstecher
Corta Massas Quadrado Canelado



ref.	L (cm)		Bar Code
784202	2-10	1/6/36	8411922084597

Cortamasas Cuadrado Liso (9 uds.)

Square Plain Dough Cutter
Emporte-Pièce Carré Lisse
Quadratisch Flach Ausstecher
Corta Massas Quadrado Liso



ref.	L (cm)		Bar Code
784203	2-10	1/6/36	8411922084603

Cortamasas Estrella Liso (6 uds.)

Star Plain Dough Cutter
Emporte-Pièce Étoile Lisse
Stern Flach Ausstecher
Corta Massas Estrela Liso



ref.	L (cm)		Bar Code
784206	3-12	1/6/36	8411922084634

Cortamasas Corazón Liso (7 uds.)

Heart Plain Dough Cutter
Emporte-Pièce Coeur Lisse
Herz Flach Ausstecher
Corta Massas Coração Liso



ref.	L (cm)		Bar Code
784208	2-11	1/6/36	8411922084658

Cortamasas Hexágono Liso (9 uds.)

Hexagon Plain Dough Cutter
Emporte-Pièce Hexagone Lisse
Sechseck Flach Ausstecher
Corta Massas Hexagonal Liso

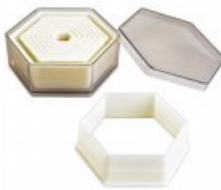

ref.	L (cm)		Bar Code
784204	1,5-9	1/6/36	8411922084610





Rodillo Cortapastas Circular

Circular Pasta Cutter Roller
Rouleau Coupe-Pâtes Circulaire
Teigrad Für Kreisform
Rolo Corta Massas Circular



ref.	Ø (cm)		Bar Code
683700	4-6-8-10	1/6/24	8411922457186

Cortador Marcador Copo de Nieve

Snowflake Cutter Mold
Emporte-Pièce Tampon à Biscuit Flocon de Neige
Ausstecher Stempel Schneeflocke
Cortador Relevo Floco de Neve



ref.	L (cm)		Bar Code
723400	10	6/48	8411922454543

Cortador Marcador GINGERMAN

Ginger Cutter Mold
Emporte-Pièce Tampon à Biscuit Ginger
Ausstecher Stempel Lebkuchenfigur
Cortador Relevo Homem de Gengibre



ref.	L (cm)		Bar Code
723401	10	6/48	8411922454536

Cortador Marcador Abeto

Pine Tree Cutter Mold
Emporte-Pièce Tampon à Biscuit Sapin De Noël
Ausstecher Stempel Tanne
Cortador Relevo Abeto



ref.	L (cm)		Bar Code
723402	11	6/48	8411922454550

Cortapastas Chico Chica

Girl Boy Dough Cutter
Emporte-Pièce Fille Garçon
Junge Mädchen Ausstecher
Corta Massas Menino Menina



ref.	L (cm)		Bar Code
789007	10	6/72	8411922090666

Cortapastas Doughnut Corazón

Doughnut Heart Dough Cutter
Emporte-Pièce Doughnut Coeur
Doughnut Herz Ausstecher
Corta Massas Doughnut Coração



ref.	Ø (cm)		Bar Code
794550	5,5+8	6/72	8411922093582

Cortapastas Calabaza

Pumpkin Dough Cutter
Emporte-Pièce Citrouille
Kürbis Ausstecher
Corta Massas Abóbora



ref.	∅ (cm)	H (cm)	📦	Bar Code
789000	12	2	6/72	8411922089912

Cortapastas Futbol

Football Dough Cutter
Emporte-Pièce Football
Fußball Ausstecher
Corta Massas Futebol



ref.	∅ (cm)	📦	Bar Code
789006	6,5+5,5	6/144	8411922090062

Cortapastas Bandera

Flag Dough Cutter
Emporte-Pièces Drapeau
Flagge Ausstecher
Corta Massas Bandeira



- 24 palitos
- 24 sticks

ref.	L (cm)	W (cm)	📦	Bar Code
792100	6	4	6/96	8411922091908

Cortapastas Plástico (8 uds.)

Plastic Dough Cutter
Emporte-Pièces Plastique
Plastik Ausstecher
Corta Massa Plastico



ref.	📦	Bar Code
701500	12/96	8411922613001

Cortapastas Couple

Couple Dough Cutter
Emporte-Pièce Couple
Ausstecher Couple
Corta Massas Couple



ref.	L (cm)	W (cm)	📦	Bar Code
794600	13	7	6/108	8411922093322

Cortapastas Ciudades

Cities Dough Cutter
Emporte-Pièces Villes
Stadt Ausstecher
Corta Massas Cidade



ref.	L (cm)	📦	Bar Code
789010	10	6/36	8411922434606

Cortador para Chebakia 2 Medidas

Chebakia Cutter 2 Sizes
Coupeur de Chebakia 2 Tailles
Chebakia Ausstecher 2 Größen
Cortador de Chebakia 2 Tamanhos



- Plástico
- Plastic

ref.	L (cm)	W (cm)	H (cm)	📦	Bar Code
756450	9,20	7,60	2	6/144	8411922456547

Set 10 Cortapastas Abeto

Fir Tree Dough Cutter
Emporte-Pièce Sapin
Fichte Ausstecher
Corta Massas Abeto



ref.	L (cm)		Bar Code
798900	20	6/72	8411922434040

Cortapastas Números

Numbers Dough Cutter
Emporte-Pièce Numéros
Ausstecher Zahlen
Corta Massas Números



ref.	H (cm)		Bar Code
794900	6	6/36	8411922093568

Cortapastas Abecedario

Alphabet Dough Cutter
Emporte-Pièce Alphabet
Ausstecher Alphabet
Corta Massas Alfabeto



ref.	H (cm)		Bar Code
794800	4,50	6/24	8411922093551

Set 5 Cortapastas Ginger

Ginger Dough Cutters
Emporte-Pièces Ginger
Lebkuchen Ausstechformen
Corta Massas Gengibre



ref.	L (cm)		Bar Code
794400	4-9	12/72	8411922093346

Moldes Petit Choc Lamour

Petit Choc Lamour Molds
Moules Petit Choc Lamour
Petit Choc Lamour Förmchen
Formas Petit Choc Lamour



- **Silicona**
- **1 cortador / 2 moldes**
- Silicone
- 1 cutter / 2 molds

ref.	∅ (cm)		Bar Code
793800	7	1/6/24	8411922092646

Moldes Petit Choc Kids

Petit Choc Kids Molds
Moules Petit Choc Kids
Petit Choc Kids Förmchen
Formas Petit Choc Kids



- **Silicona**
- **1 cortador / 2 moldes**
- Silicone
- 1 cutter / 2 molds

ref.	L (cm)	W (cm)		Bar Code
793700	6,50	5	1/6/24	8411922092639



Cortapastas con Expulsor Just Married

Just Married Dough Cutter with Ejector
Emporte-Pièce avec Poussoir Just Married
Ausstecher mit Ausformhilfe Just Married
Corta Massas com Expulsor Just Married



ref.	L (cm)	W (cm)		Bar Code
794700	11	10	6/48	8411922093537

Cortapastas con Expulsor Novios

Bride and Groom Dough Cutter with Ejector
Emporte-Pièce avec Poussoir Les Mariés
Ausstecher mit Ausformhilfe Brautpaar
Corta Massas com Expulsor Noivos



ref.	L (cm)	W (cm)		Bar Code
795000	13	11	6/48	8411922093599

Cortapastas con Expulsor Payaso

Clown Dough Cutter with Ejector
Emporte-Pièce avec Poussoir Clown
Ausstecher mit Ausformhilfe Clown
Corta Massas com Expulsor Palhaço



ref.	L (cm)	W (cm)		Bar Code
795001	14	12	6/36	8411922435115

Set 3 Cortadores Marcadores con Expulsor Copo de Nieve

Set 3 Snowflake Cutters-Markers
Jeu de 3 Emporte-Pièce Tampon Flocons de Neige
Set 3 Ausstecher und Stempel Schneeflocke
3 Cortadores Marcadores Floco de Neve



ref.	∅ (cm)		Bar Code
682250	5,5-7,0	6/48	8411922455861

Set 4 Cortapastas con Expulsor Fiesta

Party Dough Cutters with Ejector
Emporte-Pièces avec Poussoir Fête
Ausstecher mit Ausformhilfe Party
Corta Massas com Expulsor Festa



ref.	L (cm)		Bar Code
789009	8	6/36	8411922090680

Cortapastas con Expulsor Halloween (4 uds.)

Halloween Dough Cutter with Ejector
 Emporte-Pièce avec Pousoir Halloween
 Ausstecher mit Ausformhilfe Halloween
 Corta Massas com Expulsor Halloween



ref.	L (cm)		Bar Code
733000	5	6/96	8411922086614

Cortapastas con Expulsor San Valentín (4 uds.)

Valentine's Day Dough Cutter with Ejector
 Emporte-Pièce avec Pousoir Saint-Valentin
 Ausstecher mit Ausformhilfe Valentinstag
 Corta Massas com Expulsor São Valentim



ref.	L (cm)		Bar Code
732900	5	6/96	8411922086607

Cortapastas con Expulsor Navidad (4 uds.)

Christmas Dough Cutter with Ejector
 Emporte-Pièce avec Pousoir Noël
 Ausstecher mit Ausformhilfe Weihnachten
 Corta Massas com Expulsor Natal



ref.	L (cm)		Bar Code
733100	5	6/96	8411922086621

Cortapastas con Expulsor Safari (4 uds.)

Safari Dough Cutter with Ejector
 Emporte-Pièce avec Pousoir Safari
 Ausstecher mit Ausformhilfe Safari
 Corta Massas com Expulsor Safari



ref.	L (cm)		Bar Code
734700	4,5-5,5	6/96	8411922088953

Cortapastas con Expulsor Baby (4 uds.)

Baby Dough Cutter with Ejector
 Emporte-Pièce avec Pousoir Baby
 Ausstecher mit Ausformhilfe Baby
 Corta Massas com Expulsor Baby



ref.	L (cm)		Bar Code
734900	4,5-5,5	6/96	8411922088977

Cortapastas con Expulsor Alfabeto

Alphabet Dough Cutter with Ejector
 Emporte-Pièce avec Pousoir Alphabet
 Ausstecher mit Ausformhilfe Alphabet
 Corta Massas com Expulsor Alfabeto



ref.	H (cm)		Bar Code
793050	4	1/6/24	8411922435443

Cortapastas con Expulsor Números

Numbers Dough Cutter with Ejector
 Emporte-Pièce avec Poussoir Numéros
 Ausstecher mit Ausformhilfe Zahlen
 Corta Massas com Expulsor Números



ref.	H (cm)		Bar Code
793000	4	1/6/24	8411922092455

Cortapastas con Expulsor Petit beurre

Petit Beurre Dough Cutter with Ejector
 Emporte-Pièce avec Poussoir Petit Beurre
 Ausstecher mit Ausformhilfe für Petit Beurre
 Corta Massas com Expulsor Petit Beurre

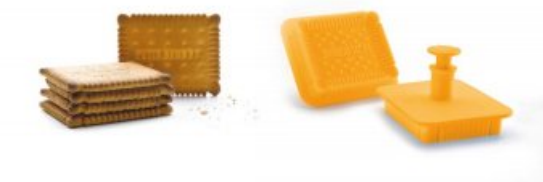

ref.	L (cm)	W (cm)		Bar Code
776800	7	5,50	6/72	8411922088007

Set Cortapastas con Expulsor Niño Comunión + Biblia

Set Dough Cutter with Ejector Boy Communion + Bible
 Set Emporte-Pièce avec Poussoir Garçon Communion + Bible
 Set Ausstecher mit Ausformhilfe Junge Kommunion + Bibel
 Jogo Corta Massas com Expulsor Menino Comunhão + Bíblia



ref.	L (cm)	W (cm)		Bar Code
788903	10+8	4,8+5,5	6/24	8411922092608

Set Cortapastas con Expulsor Niña Comunión + Cáliz

Set Dough Cutter with Ejector Girl Communion + Chalice
 Set Emporte-Pièce avec Poussoir Fille Communion + Calice
 Set Ausstecher mit Ausformhilfe Mädchen Kommunion + Kelch
 Jogo Corta Massas com Expulsor Menina Comunhão + Cálice



ref.	L (cm)		Bar Code
788902	10+10	6/72	8411922089905

Cortapastas con Expulsor Galleta María

Maria Biscuit Cutter with Ejector
 Emporte-Pièce avec Poussoir Biscuit Maria
 Ausstecher mit Ausformhilfe für Maria Kekse
 Corta Massas com Expulsor para Bolachas Maria



- Plástico
- Plastic



ref.	Ø (cm)	H (cm)		Bar Code
681800	7,50	5	6/72	8411922455595

Cortapastas con Expulsor Brezel

Brezel Dough Cutter with Ejector
Emporte-Pièce avec Pousoir Bretzel
Brezel Ausstecher mit Ausformhilfe
Corta Massas com Expulsor Brezel



- Acero Estañado
- Tin Plated Steel

ref.	L (cm)	W (cm)		Bar Code
774505	6,50	4,50	6/144	8411922083491

Cortapastas con Expulsor Rectangular

Rectangular Dough Cutter with Ejector
Emporte-Pièce avec Pousoir Rectangulaire
Rechteckige Ausstecher mit Ausformhilfe
Corta Massas com Expulsor Rectangular



- Acero Estañado
- Tin Plated Steel

ref.	L (cm)	W (cm)		Bar Code
774504	6	4,50	6/144	8411922083484

Cortapastas.

Cortapastas Metálico.



Set 3 Cortapastas Lisos

Plain Dough Cutters
Emporte-Pièces étamés Lisses
Glatte Ausstecher
Corta Massas Lisas



- Acero Estañado
- Tin Plated Steel

ref.	∅ (cm)		Bar Code
724100	5+6+7	6/144	8411922082067

Set 3 Cortapastas Rizados

Fluted Dough Cutters
Emporte-Pièces Dentelés
Welliges Ausstecher
Corta Massas Canelados



- Acero Estañado
- Tin Plated Steel

ref.	∅ (cm)		Bar Code
724000	5+6+7	6/144	8411922082050

Cortador de Doughnuts

Doughnut Cutter
Coupeur de Doughnut
Doughnut Ausstecher
Cortador de Doughnut



- Acero Inoxidable
- Mango de Acero Inoxidable
- Stainless Steel
- Stainless Steel Handle

ref.	∅ (cm)	∅ (cm)		Bar Code
709200	7,50	3,50	6/144	8411922076912
709209	9	4	6/96	8411922081954

Cortador Rizado con Asa

Fluted Dough Cutter with Handle
Coupeur Dentelé avec Anse
Welliges Ausstecher mit Griff
Cortador Rizado com Pega



- Acero Inoxidable
- Mango de Acero Inoxidable
- Stainless Steel
- Stainless Steel Handle

ref.	∅ (cm)		Bar Code
722808	7,50	6	8411922080537

Cortapastas Inox Redondos Lisos

Round Plain Stainless Steel Dough Cutter
 Emporte-Pièces Inox Ronds Lisses
 Edelstahl Ausstecher Rund Glatt
 Corta Massas Inox Redondo Liso



11 uds: 2-3-4-4,5-5-6-6,5-7-8-8,5-9 cm

ref.		Bar Code
703500	6/60	8411922068443

Cortapastas Estañados Lisos

Tin-Plated Plain Dough Cutters
 Emporte-Pièces Étamés Lisses
 Verzinnte Ausstecher Glatt
 Corta Massas Estanhados Lisos



11 uds: 2-3-4-4,5-5-6-6,5-7-8-8,5-9 cm

ref.		Bar Code
702700	6/60	8411922207958

Cortapastas Estañados Números (9 uds.)

Tin-Plated Numbers Dough Cutters
 Emporte-Pièces Étamés Numéros
 Verzinnte Ausstecher Zahlen
 Corta Massas Estanhados Numeros



ref.	W (cm)		Bar Code
702400	2,50	6/72	8411922207927

Cortapastas Estañados Letras (26 uds.)

Tin-Plated Letters Dough Cutters
 Emporte-Pièces Étamés Lettres
 Verzinnte Ausstecher Buchstaben
 Corta Massas Estanhados Letras



ref.	W (cm)		Bar Code
702500	2,50	6/60	8411922207934

Cotapastas Octogono (6 uds.)

Octagon Dough Cutter
 Emporte-Pièces Octogone
 Octogon Ausstecher
 Corta Massa Octogono



ref.	L (cm)		Bar Code
729600	4-9	6/144	8411922086041

Cotapastas Triangular (6 uds.)

Triangular Dough cutter
 Emporte-Pièces Triangulaire
 Dreieckiger Ausstecher
 Corta Massas Triangular



ref.	L (cm)		Bar Code
723900	2,5+3,5+4,5+5+6+7	6/144	8411922082043

Cortapastas Variados (6 uds.)

Various Dough Cutters
 Emporte-Pièces Variés
 Assortierte Ausstechformen
 Corta Massas Sortidos



- Acero Inoxidable
- Stainless Steel

ref.		Bar Code
801000	6/144	8411922707007

Cortapastas Cupcake

Cupcake Dough Cutter
Emporte-Pièce Cupcake
Ausstecher Cupcake
Corta Massas Cupcake



ref.	L (cm)	W (cm)	H (cm)	📦	Bar Code
735700	10,80	10,30	2,50	6/72	8411922089110

Set Cortapastas Huevo de Pascua

Set Easter Egg Dough Cutters
Jeu Emporte-Pièces Oeuf de Pâques
Set Ostereier Ausstecher
Jogo Corta Massas Ovo de Páscoa



ref.	L (cm)	W (cm)	H (cm)	📦	Bar Code
794304	12	10		6/12/72	8411922093391

Set Cortapastas Ginger Chico

Set Ginger Dough Cutters Boy
Jeu Emporte-Pièces Ginger Garçon
Set Lebkuchen Ausstecher Junge
Jogo Corta Massas Gengibre Menino



ref.	L (cm)	W (cm)	H (cm)	📦	Bar Code
794303	15	10		6/12/72	8411922093384

Set Cortapastas Ginger Chica

Set Ginger Dough Cutters Girl
Jeu Emporte-Pièces Ginger Fille
Set Lebkuchen Ausstecher Mädchen
Jogo Corta Massas Gengibre Menina



ref.	L (cm)	W (cm)	H (cm)	📦	Bar Code
794302	14	11		6/12/72	8411922093377

Set 7 Cortapastas Estañados Navidad

Christmas Tin-Plated Dough Cutters
Emporte-Pièces Étamés Noël
Verzinnnte Ausstecher Weihnachten
Corta Massas Estanhados Natal



ref.	L (cm)	H (cm)	📦	Bar Code
723800	7-11		6/72	8411922082036

Set 7 Cortapastas San Valentín

Valentine's Day Dough Cutters
Emporte-Pièce Saint-Valentin
Ausstecher Valentinstag
Corta Massas São Valentim



ref.	L (cm)	H (cm)	📦	Bar Code
736600	4-9		6/72	8411922091786

Set 7 Cortapastas Animales Marinos

Sea Animal Dough Cutters
Emporte-Pièces Animaux Marins
Ausstecher Meerestiere
Corta Massas Animais Marinhos

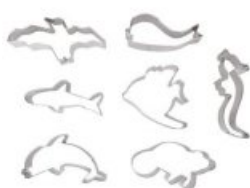

ref.	L (cm)	H (cm)	📦	Bar Code
723500	8-12		6/72	8411922082005

Set 7 Cortapastas Estañados Halloween

Halloween Tin-Plated Dough Cutters
Emporte-Pièces Étamés Halloween
Verzinnnte Ausstecher Halloween
Corta Massas Estanhados Halloween



ref.	L (cm)	H (cm)	📦	Bar Code
723700	7-10		6/72	8411922082029

Cortadores y Marcadores.

Lira para Tartas

Cake Lyre
Lyre pour Gâteaux
Tortenbodenschneider mit Schneidedraht
Lira para Bolos



- Acero Inoxidable
- Stainless Steel

ref.	L (cm)		Bar Code
708933	32	6/48	8411922076820

Hilo de Repuesto Lira para Tartas (10 uds.)

Cake Lyre Thread Replacement
Fil Rechange Lyre Gâteaux
Ersatz Draht für Kuchenschneider
Fio para Cortador de Bolos



- Acero Inoxidable
- Stainless Steel

ref.	L (cm)		Bar Code
725033	32	1/500	8411922082906

Marcadores de Tartas y Tortillas

Cake and Omelette Markers
Marqueurs pour Gâteaux et Tortillas
Marker-Set-Für Torten und Tortillas
Marcadores de Tartes e Tortilhas



- Plástico
- Para las divisiones de porciones más difíciles
- Plastic
- For making the most difficult portion divisions





ref.	∅ (cm)		Bar Code
684600	5	6/96	8411922457964

Marcador de Tartas en Porciones

Portion Cake Marker
Marqueur de Gâteaux à Portions
Kuchen Marker in Portionen
Marcador de Bolo em Porções



- Plástico
- Plastic

ref.	∅ (cm)			Bar Code
732700	26	10+12	6	8411922086584
732800	26	14+16	6	8411922086591

Sellos para Galletas

Cookie Stamps
Timbres pour Biscuits
Keks-Stempel
Selos para Biscoitos



- Silicona
- Plástico
- Silicone
- Plastic



ref.	∅ (cm)	H (cm)		Bar Code
681700	6,60	9	6/48	8411922455588

Pisador para Tartaletas

Tart Dough Pusher
Poussoir pour Tartelettes
Törtchenstamper
Prensa para Tarteletes



- Madera
- Wood

ref.	L (cm)	Ø (cm)		Bar Code
784400	21	6,8+4	6/36	8411922085068

Set Espátula + Decorador

Set Spatula + Decorator
Jeu Spatule + Décorateur
Set Spatel + Dekorateur
Jogo Espátula + Decorador



- Plástico
- Plastic

ref.		Bar Code
761100	12/288	8411922621839

Cortador para Masas / Medidor de Spaguetti

Dough cutter / Pasta Measurer
Coupe-Pâtes / Doseur à Spaghetti
Teigschneider / Spaghetti-Messgerät
Cortador de Massa / Medidor de Esparguete



ref.	L (cm)	W (cm)		Bar Code
796500	15	12	12/144	8411922093803

Rasqueta Cortamasas Profesional Recta

Professional Straight Dough Cutter
Racloir a patisserie Droit
Gewerblicher Teigschneider
Gerade
Raspador/Corta-Massas
Profissional Reto



ref.	L (cm)	W (cm)		Bar Code
686000	11,50	10,50	6	8411922459067

Rasqueta Cortamasas Profesional Curva

Professional Curved Dough Cutter
Racloir a patisserie Courbé
Gewerblicher Teigschneider
Gewölbt
Raspador/Corta-Massas
Profissional Curvo



ref.	L (cm)	W (cm)		Bar Code
686010	11,50	10,50	6	8411922459074

Pinza para Masas

Crimper
Pinze à Chiqueter la Pâte
Teigzange
Pinças para Massas



- Acero Inoxidable
- Stainless Steel

ref.	L (cm)		Bar Code
770500	14	6/108	8411922454765

Molde Tarta Mini "PIE" Enrejado

Lattice Mini Pie Mold
Moule à Gâteau en Treillis pour Mini "Pie"
Mini "Pie" Kuchenform Gitter
Molde Tarta Mini "Pie" Grelha



- Plástico
- Plastic

ref.	Ø (cm)	H (cm)		Bar Code
682200	11,50	4,50	6/48	8411922455847

Molde Tarta Mini "PIE" Manzana

Apple Mini Pie Mold
Mini Moule à Gâteau "Pie" aux Pommes
Mini "Pie" Kuchenform Apfel
Molde Tarta Mini "Pie" Maçã



- Plástico
- Plastic

ref.	L (cm)	H (cm)		Bar Code
682210	10	10,80	6/48	8411922455854

Cortador Crostata Rombo

Diamond Crostata Cutter
 Découpeur de Crostata Rombo
 Crostata-Schneider Raute
 Cortador para Tartes Losangos



- Plástico
- Plastic

ref.	∅ (cm)		Bar Code
686100	30	6/12	8411922459104

Cortador Crostata Arabesque

Arabesque Crostata Cutter
 Découpeur de Crostata Arabesque
 Crostata-Schneider Arabische Art
 Cortador para Tartes Árabe



- Plástico
- Plastic

ref.	∅ (cm)		Bar Code
686110	30	6/12	8411922459111

Rodillo Cortador de Croissant Mini

Mini Croissant Roller
 Rouleau Croissant Mini
 Mini-Croissant-Ausstecher-Rolle
 Rolo de Corte para Croissant Mini



- Acero Inoxidable
- Madera
- Incluye Receta
- Stainless Steel
- Wood
- Includes Recipe



ref.	L (cm)	W (cm)		Bar Code
787701	9	9	6/48	8411922453911

Rodillo Cortador de Croissant

Croissant Cutting Roller
 Rouleau Coupe-Croissant
 Croissantschneider-Rolle
 Rolo de Corte para Croissants



- Plástico
- Incluye Receta
- Plastic
- Includes Recipe



ref.	L (cm)	W (cm)		Bar Code
798100	18	10	6/24	8411922433630

Rodillo Punteador

Roller Docker
 Rouleau Pique Vite
 Stitch Roller
 Rolo Furador



- Plástico
- Plastic



ref.	L (cm)		Bar Code
771700	12	6/120	8411922077964

Rodillo Rombos

Rhombus Roller
 Rouleau Losanges
 Rhombus-Nudelholz
 Rolo de Massa Losangos



- Plástico
- Plastic



ref.	L (cm)		Bar Code
771800	12	6/120	8411922077971

Rodillo Decorador Noël

Embossed Rolling Pin Noël
Rouleau à Pâtisserie Gravé Noël
Nudelholz mit Prägung Noël
Rolo de Decoração Noël



• Madera de Haya

• Beech Wood



ref.	L (cm)	Ø (cm)		Bar Code
747950	39,50	5	6/12	8411922454789

Rodillo Decorador Seed

Embossed Rolling Pin Seed
Rouleau à Pâtisserie Gravé Seed
Nudelholz mit Prägung Seed
Rolo de Decoração Seed



ref.	L (cm)	Ø (cm)		Bar Code
747951	39,50	5	6/12	8411922454796

Rodillo Decorador Vinter

Embossed Rolling Pin Vinter
Rouleau à Pâtisserie Gravé Vinter
Nudelholz mit Prägung Vinter
Rolo de Decoração Vinter



ref.	L (cm)	Ø (cm)		Bar Code
747952	39,50	5	6/12	8411922454802

Rodillo Decorador Hex

Embossed Rolling Pin Hex
Rouleau à Pâtisserie Gravé Hex
Nudelholz mit Prägung Hex
Rolo de Decoração Hex



ref.	L (cm)	Ø (cm)		Bar Code
747953	39,50	5	6/12	8411922454819

Guía Cortabizcochos Plegable

Folding Cake Leveler
Guide Coupe-Gâteau Pliant
Tortenboden Schneidhilfe
Guia Corta Pão de Ló Dobrável



- **ABS**
- **Regulable**
- **Para bizcochos redondos, cuadrados y otras formas**
- ABS
- Adjustable
- For round and square cakes, and cakes with other shapes



ref.	L (cm)	H (cm)		Bar Code	
748700V	20-35	10	1/6/24	8411922438338	GREEN
748700R	20-35	10	1/6/24	8411922438345	SWEET

Guía Cortabizcochos en Capas

Cake Leveler
Guide Coupe-Gâteau
Tortenboden Schneidhilfe
Guia Corta Pão de Ló em Camadas



- **Acero Inoxidable**
- **Regulable**
- ***No disponible en todos los paises**
- Stainless Steel
- Adjustable
- *Not available in all countries

ref.	∅ (cm)	H (cm)		Bar Code	
731200	24-30	8,50	1/12	8411922086096	XL
731210	16-20	8	1/6/12	8411922459432	L



Mangas y Boquillas.

ACERO INOXIDABLE 18/10

STAINLESS STEEL 18/10

ACIER INOXYDABLE 18/10

ROSTFREIER STAHL 18/10

AÇO INOXIDÁVEL 18/10



Boquilla Redonda

Round Nozzle

Douille Ronde

Runde Spritztülle

Boquilha Redonda



ref.	mark	Ø (mm)	h (mm)	l (mm)	adap	📦	Bar Code
250000	(1)	0,50	35	17	1	6/12/504	8411922090970
250001	(2)	1	35	17	1	6/12/504	8411922090987
25001A	(3)	1,50	32	17	1	6/12/504	8411922090994
250002	(4)	2	32	17	1	6/12/504	8411922091007
250003	(6)	3	32	17	1	6/12/504	8411922091014
250004	(8)	4	30	18	1	6/12/504	8411922091021
250006	(10)	6	45	25	2	6/12/504	8411922091038
250007	(11)	7	30	18	1	6/12/504	8411922091045
250008	(12)	8	45	25	2	6/12/504	8411922091052
250010	(2A)	10	50	30	2	6/12/504	8411922091069
250012	(1A)	12	50	30	2	6/12/504	8411922091076

Boquilla Estrella Abierta

Open Star Nozzle
Douille Étoile Ouverte
Offener Stern Spritztülle
Boquilha Estrela Aberta

ref.	mark	Ø (mm)	h (mm)	h ₁ (mm)	adap	📦	Bar Code
250104	820	4	50	22	2	6/12/504	8411922091083
250106	821	6	50	24	2	6/12/504	8411922091090
250108	822	8	45	23	2	6/12/504	8411922091106
250109	1M	9	50	30	2	6/12/504	8411922091113
250111	827	11	50	30	2	6/12/504	8411922091120



Boquilla Estrella Multipunta

Multiwave Star Nozzle
Douille Étoile Multibranche
Mehrzackiger Stern Spritztülle
Boquilha Estrela Multiponta

ref.	mark	Ø (mm)	h (mm)	h ₁ (mm)	adap	📦	Bar Code
250208	199	8	28	21	1	6/12/504	8411922091137
250210	4B	10	45	23	2	6/12/504	8411922091144
250212	6B	12	50	30	2	6/12/504	8411922091151



Boquilla Estrella Cerrada

Closed Star Nozzle
Douille Étoile Fermée
Geschlossen Stern Spritztülle
Boquilha Estrela Fechada

ref.	mark	Ø (mm)	h (mm)	h ₁ (mm)	adap	📦	Bar Code
250303	30	3	33	17	1	6/12/504	8411922091168
250304	2D	4	45	25	2	6/12/504	8411922091175
250306	2F	9	50	30	2	6/12/504	8411922091182
250310	1B	10	53	35	-	6/12/504	8411922091199
250312	1F	12	50	35	-	6/12/504	8411922091205



Boquilla Pétalos

Petals Nozzle
Douille Pétales
Blütenblätter Spritztülle
Boquilha Petalas

ref.	mark	Ø (mm)	h (mm)	h ₁ (mm)	adap	📦	Bar Code
250606	59	6	28	17	1	6/12/504	8411922091274
250610	61	10	30	17	1	6/12/504	8411922091281
250611	104	11	27	16	1	6/12/504	8411922091298
250616	126	16	40	23	2	6/12/504	8411922091304



Boquilla Hojas

Leaves Nozzle
Douille Feuilles
Blätter Spritztülle
Boquilha Folhas

ref.	mark	Ø (mm)	h (mm)	h ₁ (mm)	adap	📦	Bar Code
250708	68	8	30	17	1	6/12/504	8411922091328
250711	70	11	32	20	1	6/12/504	8411922091335



Boquilla Cesta

Basket Nozzle
Douille Tressage
Korb Spritztülle
Boquilha Serra

ref.	mark	Ø (mm)	h (mm)	l (mm)	adap		Bar Code
250416	2B	16	40	23	2	6/12/504	8411922091229
250420	1D	20	45	27	2	6/12/504	8411922091236



Boquilla Relleno

Filler Nozzle
Douille Petits Choux
Einfüllstutzen
Boquilha Recheado

ref.	mark	Ø (mm)	h (mm)	l (mm)	adap		Bar Code
250504	264	4	90	22	2	6/12/504	8411922091243
250508	232	8	90	22	2	6/12/504	8411922091250



Boquilla Flor

Flower Nozzle
Douille Fleur
Blume Spritztülle
Boquilha Flor

ref.	mark	Ø (mm)	h (mm)	l (mm)	adap		Bar Code
251009	108	9	20	30	1	6/12/504	8411922091366



Boquilla Hierba

Grass Nozzle
Douille Pelouse
Gras Spritztülle
Boquilha Ervas

ref.	mark	Ø (mm)	h (mm)	l (mm)	adap		Bar Code
250909	233	10	25	17	1	6/12/504	8411922091342



Boquilla Conchas / Cuerda

Shell / Rope Nozzle
Douille Coquilles / Corde
Muschel / Seil Spritztülle
Boquilha comcha/Corda

ref.	mark	Ø (mm)	h (mm)	l (mm)	adap		Bar Code
250908	105	9	30	17	1	6/12/504	8411922091359



Boquilla Saint Honoré

Saint Honoré Nozzle
Douille Saint-Honoré
Saint Honoré Spritztülle
Boquilha Saint Honore

ref.	mark	Ø (mm)	h (mm)	l (mm)	adap		Bar Code
252300	580	13	40	25	2	6/12/504	8411922439663



Set 12 Boquillas Rusas Standard

Set 12 Standard Russian Nozzles
 Jeu 12 Douilles Russes Standard
 Set 12 Russische Spritztüllen Standard
 Jogo 12 Boquilhas Russas Standard



ref.	Ø (cm)	H (cm)	📦	Bar Code
252000	1,60	4	1/6/24	8411922437614

Set 12 Boquillas Rusas XL

Set 12 Russian Nozzles XL
 Jeu 12 Douilles Russes XL
 Set 12 Russische Spritztüllen XL
 Jogo 12 Boquilhas Russas XL



ref.	Ø (cm)	H (cm)	📦	Bar Code
252001	2,30	4	1/6/24	8411922437621

Set 8 Boquillas Rusas Navidad

Set 8 Christmas Russian Nozzles
 Jeu 8 Douilles Russes Noël
 Set 8 Russische Spritztüllen für Weihnachten
 Jogo 8 Boquilhas Russas Natal



ref.	Ø (cm)	H (cm)	📦	Bar Code
252400	2,40	3,70	6/72	8411922441796

Set 6 Cornetes

Set 6 Plastic Nozzles
 Jeu de 6 Douilles
 Set 6 Düsen
 Jogo 6 Boquilhas



ref.	📦	Bar Code
000934	1/6/72	8411922009347



Set 6 Boquillas Rusas Esféricas

Set 6 Spherical Russian Nozzles
 Jeu 6 Douilles Russes Sphériques
 Set 6 Russische Kugelförmig Spritztüllen
 Jogo 6 Boquilhas Russas Esfericas



ref.	H (cm)	📦	Bar Code
252100	6,50	6/72	8411922438536

Cepillo Limpiador para Cornetes (2 uds.)

Nozzle Cleaning Brush
 Brosse de Nettoyage pour Düsen
 Reinigungsbürste für Düsen
 Escova Limpa Boquilhas



ref.	L (cm)	📦	Bar Code
760400B	10,50	1/10/400	8411922797008



Adaptador para Boquillas N° 2

Nozzle Adapter N°2
Adaptateur Douilles N° 2
Düsen Adapter Nr. 2
Adaptador de Boquillas N° 2



ref.		Bar Code
760604	6/144	8411922091847

Adaptador para Boquillas N° 1 (2 uds.)

Nozzle Adapter N°1
Adaptateur Douilles N° 1
Düsen Adapter Nr. 1
Adaptador de Boquillas N° 1



ref.	∅ (cm)	H (cm)		Bar Code
760603	2,50	3	6/144	8411922090024

Adaptador Triple para Boquillas Grandes/Rusas

Triple Adapter for Russian Nozzles
Triple Adaptateur pour Douilles Russes
Dreifach-Adapter für Russische Spritztüllen
Adaptador para Boquillas Grandes/Russas



ref.	∅ (cm)		Bar Code
252200	2,30	6/216	8411922439656



Mangas Desechables (10 uds.)

Disposable Pastry Bags
Poches à Pâtisserie Jetables
Einweg Spritzbeutel
Sacos de Pasteleiro Descartáveis

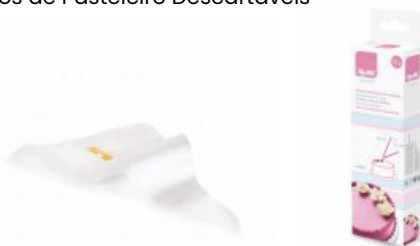

ref.	L (cm)		Bar Code
760030	30	1/12	8411922620306
760045	40	1/12	8411922620450
760055	55	1/12	8411922208962

Mangas Desechables en Rollo (100 uds.)

Roll of Disposable Pastry Bags
Rouleau de Poches à Pâtisserie Jetables
Einweg Spritzbeutel auf der Rolle
Sacos de Pasteleiro Descartáveis em Rolo



ref.	L (cm)		Bar Code
760030E	30	1/10	8411922435863
760040E	40	1/10	8411922435870
760055E	55	1/10	8411922435887

Manga Antideslizante Desechable (100 uds.)

Non-slip Disposable Pastry Bag (100 pcs)
Poche à Pâtisserie Antiglissante Jetable (100 pcs)
Einweg-Anti-Rutsch-Spritzbeutel (100 stk.)
Saco de Pasteleiro Antiderrapante Descartável (100 uds.)



ref.	L (cm)	📦	Bar Code
773740	40	1/4	8411922078930
773755	55	1/10	8411922078947

Manga de Repostería Flexible

Flexible Pastry Bag
Poche à Pâtisserie Flexible
Flexibler Spritzbeutel
Saco de Pasteleiro Flexível



- Innovative Composite Polymer
- Innovative Composite Polymer



ref.	L (cm)	📦	Bar Code
752734	34	1/12/72	8411922084061
752740	40	1/12/72	8411922084078
752745	45	1/12/72	8411922084085
752750	50	1/12/72	8411922084092
752755	55	1/12/72	8411922084108
752760	60	1/12/72	8411922084115

Manga Flexible Triple

Triple Flexible Pastry Bag
Poche à Pâtisserie Flexible Triple
Dreifache Flexible Spritzbeutel
Saco de Pasteleiro Triplo Flexível



- Innovative Composite Polymer
- Innovative Composite Polymer



ref.	L (cm)	📦	Bar Code
798640	40	1/6/72	8411922433975

Manga Desechable Doble

Double Disposable Pastry Bag
Poche à Pâtisserie Jetable Double
Einweg Spritzbeutel Doppelt
Saco de Pasteleiro Descartável Duplo



ref.	L (cm)	📦	Bar Code
760245	45	6/72	8411922448870

Manga Flexible Doble

Double Flexible Pastry Bag
Poche à Pâtisserie Flexible Double
Doppelter Flexibler Spritzbeutel
Saco de Pasteleiro Flexível Duplo



- Innovative Composite Polymer
- Innovative Composite Polymer



ref.	L (cm)	📦	Bar Code
789440	40	6/72	8411922090031

Soporte para Mangas

Pastry Bag Holder
Support pour Poches à Pâtisserie
Spritzbeutel-Halter
Suporte para Sacos de Pasteleiro



- Plástico
- Plastic

ref.	L (cm)	W (cm)	📦	Bar Code
771400	24	10	4	8411922077919

Mangas Repostería Nylon

Nylon Pastry Bags
Poche à Pâtisserie Nylon
Nylon Spritzbeutel
Saco de Pasteleiro de Nylon



- Nylon
- Nylon

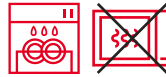

ref.	L (cm)	📦	Bar Code
756830	30	6/498	8411922774306
756835	35	6/498	8411922774351
756840	40	6/498	8411922774405
756845	45	6/498	8411922774450
756850	50	6/330	8411922774504
756860	60	6/330	8411922068610

Mangas y Boquillas.

Sets Mangas y Boquillas.

Juego Decoración Noveles (6 Cornetes + Adaptador + Manga 25cm)

Decorating Set (6 Nozzles + Adapter + Pastry Bag 25cm)
Ensemble de Décoration (6 Douilles + Adaptateur + Poche 25cm)
Dekorationsset (6 Düsen + Adapter + Spritzbeutel 25cm)
Jogo Decoração (6 Boquilhas + Adaptador + Saco Pasteleiro 25cm)



ref.	📦	Bar Code
760700	1/50/200	8411922619003

Manga Pastelera Flexible + 6 Boquillas

Flexible Pastry Bag + 6 Nozzles
Poche à Pâtisserie Flexible + 6 Douilles
Flexibler Spritzbeutel + 6 Düsen
Saco de Pasteleiro Flexível + 6 Boquilhas



ref.	L (cm)	📦	Bar Code
790100	40	12/96	8411922090437

Decorador Manga Plástico 5 Boquillas

Plastic Icing Bag 5 Nozzles
Poche à Décorer Plastique 5 Douilles
Plastik Spritzbeutel 5 Düsen
Saco Pasteleiro Plástico 5 Boquilhas



ref.	📦	Bar Code
756300	12/144	8411922600193

Set 24 Cornetes

Set of 24 Nozzles
Jeu de 24 Douilles
Set 24 Düsen
Jogo 24 Boquilhas



ref.		Bar Code
771900	1/6/24	8411922077995

Kit 10 Mangas + 6 Boquillas

Kit 10 Bags + 6 Nozzles
Kit 10 Poches + 6 Douilles
Kit 10 Spritzbeutel + 6 Düsen
Kit 10 Mangas + 6 Boquilhas



ref.		Bar Code
000946	1/6/24	8411922009460

Set 6 Cornetes de Plástico

Set 6 Plastic Nozzles
Jeu 6 Douilles en Plastique
Set 6 Plastik-Düsen
Jogo 6 Boquilhas de Plástico



ref.		Bar Code
768300	1/6/48	8411922208955

Kit para Cronuts

Cronuts Kit
Kit pour Cronuts
Bausatz für Cronuts
Jogo para Cronuts



ref.	∅ (cm)		Bar Code
793100	5,5+8	1/6/48	8411922092462

Decoración.

Set de Decoración para Cookies y Cupcakes

Cookies and Cupcakes Decoration Set
Jeu Décoration Cookies et Cupcakes
Keks- und Cupcake-Dekorationsset
Jogo de Decoração de Bolachas e Cupcakes

- Plástico
- Acero Inoxidable
- Plastic
- Stainless Steel



ref.		Bar Code
782800	1/4/16	8411922083194

Set para Cupcakes Luxe

Luxe Cupcake Set
Set de Cupcakes Luxe
Set für Cupcakes Luxe
Jogo para Cupcakes Luxe

- Plástico
- Silicona
- Acero Inoxidable
- Plastic
- Silicone
- Stainless Steel



ref.	∅ (cm)		Bar Code
735500	6	1/6/24	8411922089035

Lápiz Decorador

Decorating Pencil
Crayon de Décoration
Dekorier-Stift
Lápis de Decoração



- Plástico
- Plastic



ref.	L (cm)		Bar Code
744700	12	6/144	8411922436488

Jeringa de Repostería + 8 Boquillas

Piping Syringe + 8 Nozzles
Seringue Pâtisserie + 8 Douilles
Spritze für Gebäck + 8 Düsen
Seringa para Pastelería + 8 Bicos



- Plástico
- Plastic



ref.	L (cm)		Bar Code
744500	18	6/72	8411922436464

Vaciador de Cupcakes

Cupcake Corer
Évideur de Cupcakes
Cupcake-Ausstecher
Esvaziador de Cupcakes



- Plástico
- Plastic

ref.	∅ (cm)	H (cm)		Bar Code
735000	2,50	3,50	6/144	8411922088984

Biberón para Bañar Bizcochos

Soaker Bottle for Sponge Cake
Flacon Souple Verseur pour Imbiber les Biscuits
Einweichflasche für Kuchen Ueberzug
Biberão para Banhar Bolos



- Plástico
- Con marcas de capacidad
- Plastic
- With capacity marking

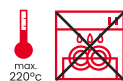

ref.	Lts	H (cm)		Bar Code
681405	0,50	22	6/96	8411922455519
681410	1	28	6/96	8411922455526

Biberón

Squeeze Bottle
Flacon Verseur Souple
Squeeze-Flasche
Biberão



- Plástico
- Con graduación
- Plastic
- With graduation



ref.	Lts		Bar Code
773901	0,125	12	8411922084566
773902	0,25	12	8411922079333
773904	0,40	12	8411922079340
773907	0,70	12	8411922079357

Hilador de Huevo

Egg Thread Funnel
Entonnoir pour Fil d'Oeuf
Eierfadentrichter
Fabricador de Fios de Ovo



- Plástico
- Plastic



ref.	∅ (cm)	H (cm)		Bar Code
749200	9	11,50	6/36	8411922438505

Set 2 Decoradores de Tarta Cruz Santiago

Set 2 St James Cross Cake Decoration
 Jeu 2 Décorateur Croix Saint-Jacques
 Set 2 Santiago Cross Tortendekorierer
 Jogo 2 Decoradores de Bolos Cruz de Santiago

- **Acero Inoxidable**
- Stainless Steel



ref.	L (cm)	W (cm)		Bar Code
781200	20+14	10+7	6/36	8411922082463

Soportes.

Rejilla Enfriartartas Redonda

Round Cake Cooler
 Grille de Refroidissement pour Gâteaux Ronde
 Runder Kuchengitter
 Grelha de Arrefecimento Redonda



- **Acero Cromado**
- Chrome Steel



ref.	∅ (cm)		Bar Code
780730	30	6/48	8411922082418

Rejilla Enfriartartas Rectangular

Rectangular Cake Cooler
 Grille de Refroidissement pour Gâteaux Rectangulaire
 Rechteckiger Kuchengitter
 Grelha de Arrefecimento Retangular

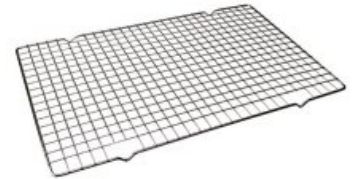

- **Acero Cromado**
- Chrome Steel



ref.	L (cm)	W (cm)		Bar Code
780825	40	25	6/30	8411922082425

Base Giratoria Alta

High Rotating Base
 Plateau Tournante Haute
 Hoher Drehsockel
 Base Giratória Alta



- **Plástico**
- Plastic



ref.	∅ (cm)	H (cm)		Bar Code
789301	31	12,50	1/6	8411922090000
789310	35	13	1/6	8411922458572

Base Giratoria Baja

Low Rotating Base
 Plateau Tournante Basse
 Niedriger Drehsockel
 Base Giratória Baixa



- **Plástico**
- Plastic

ref.	∅ (cm)	H (cm)		Bar Code
789300	31	5	6	8411922089998

Sorporte Giratorio

Rotating Stand
Support Tournant
Rotierender Ständer
Prato Giratorio

- **Acero Inoxidable**
- **Vidrio**
- Stainless Steel
- Glass



ref.	∅ (cm)	H (cm)		Bar Code
717130	30	7	1/6	8411922077599

Soporte para Cupcakes (10-12)

Cupcake Stand (10-12)
Présentoir à Cupcakes (10-12)
Stand für Cupcakes (10-12)
Suporte para Cupcakes (10-12)



- **Cartón**
- **Desechable**
- Cardboard
- Disposable

ref.	∅ (cm)	H (cm)		Bar Code
736100	25	26	12/48	8411922090284

Soporte para Cake Pops y Cupcakes

Cake Pops and Cupcakes Stand
Support pour Cake Pops et Cupcakes
Cake Pops und Cupcake-Ständer
Suporte para Cake Pops e Cupcakes



NEW

Soporte Giratorio Prof

Prof Rotating Stand
Plateau tournant Prof
Drehbarer Ständer Prof
Suporte Giratório Prof

- **Aluminio**
- **Plástico**
- Aluminium
- Plastic



ref.	∅ (cm)	H (cm)		Bar Code
665730	29	12,50	1/6	8411922475104

Soporte para Cupcakes (16-20)

Cupcake Stand (16-20)
Présentoir à Cupcakes (16-20)
Stand für Cupcakes (16-20)
Suporte para Cupcakes (16-20)



- **Cartón**
- **Desechable**
- Cardboard
- Disposable

ref.	∅ (cm)	H (cm)		Bar Code
736101	34,50	44	12/36	8411922090291

- **Plástico**
- **48 palitos**
- Plastic
- 48 sticks

ref.	∅ (cm)	H (cm)		Bar Code
827600	30	24	1/6	8411922091700

Portatartas Redondo

Cake Carrier Round
Porte-Gâteaux Ronde
Kuchenträger Rund
Porta-Bolos Redondo

- **Plástico**
- Plastic



ref.	∅ (cm)	H (cm)		Bar Code
689100	30	15	2	8411922470765

Portatartas Cuadrado

Cake Carrier Square
Porte-Gâteaux Carré
Kuchenträger Quadratisch
Porta-Bolos Quadrado

- **Plástico**
- Plastic



ref.	L (cm)	W (cm)	H (cm)		Bar Code
689110	32,50	32	16,50	2	8411922470772

Básculas.

Báscula Digital 15kg

Electronic Kitchen Scale 15 Kg
Balances de Cuisine
Électroniques 15 Kg
Elektrische Küchenwaage 15 Kg
Balança Electronica de Cozinha 15 Kg



- Vidrio
- Glass



3xAAA
NOT
included

ref.	L (cm)	W (cm)		Bar Code
708450	24	20	1/6/12	8411922457230

Báscula Digital Superfina

Super Slim Digital Scale
Balance Numérique Super Fine
Superfine Digitalwaage
Balança Digital superfina



- Acero Inoxidable
- Stainless Steel



1xCR2032
included

ref.	L (cm)	W (cm)		Bar Code
790800	21,50	17	1/6/12	8411922090574

Báscula Digital Mini

Mini Digital Scale
Balance Numérique Mini
Digitale Mini-Waage
Balança Digital Mini



- Acero Inoxidable
- Stainless Steel



2xAAA
included

ref.	L (cm)	W (cm)		Bar Code
734600	18	14	1/6/36	8411922441826

Báscula Digital

Digital Scale
Balance Numérique
Digitale Waage
Balança Digital



- Vidrio
- Glass



1xCR2032
included

ref.	L (cm)	W (cm)		Bar Code
734810	23	15	1/5/20	8411922441819

Velas.

Set 5 Velas Corazón

Set 5 Happy Birthday Candles
Jeu 5 Bougie Happy Birthday
Set 5 Herz-Kerzen
Jogo 5 Velas Coração



ref.	L (cm)		Bar Code
786203	7	12/360	8411922086362

Set 5 Velas Sonrisa

Set 5 Smile Candles
Jeu 2 Bougies Sourire
Set 5 Lächel-Kerzen
Jogo 5 Velas Sorriso



ref.	L (cm)		Bar Code
786201	7	12/360	8411922086355

Vela Coche

Car Candle
Bougie Voiture
Auto-Kerze
Vela Carro



ref.	L (cm)		Bar Code
786214	7,50	12/360	8411922088694

Vela Monstruos

Monsters Candle
Bougie Monstre
Monster Kerze
Vela Monstros



ref.	L (cm)		Bar Code
786215	8	12/360	8411922088700

Vela Balón

Ball Candle
Bougie Ballon
Kugel-Kerze
Vela Bola



ref.	L (cm)		Bar Code
786206	8	12/360	8411922086393

Vela Happy Birthday

Happy Birthday Candle
Bougie Happy Birthday
Happy Birthday Kerze
Vela Happy Birthday



ref.	L (cm)		Bar Code
786209	7	12/360	8411922086423

Velas Aniversario + Números

Birthday Candles + Numbers
Bougies Anniversaire + Numéros
Geburtstagskerzen + Zahlen
Velas de Aniversario + Números



ref.		Bar Code
706400	12/48/288	8411922072822

Velas Aniversario (24 uds.) + Soporte (12 uds.)

Birthday Candle (24 pcs) + Holder (12pcs)
Bougies Anniversaire (24 pcs) + Soutien (12pcs)
Jubiläumskerzen (24 Stk.) + Halter (12 Stk.)
Velas de Aniversário (24 uds.) + Suporte (12 uds.)



ref.		Bar Code
756200	12/48/288	8411922600186

Velas Números

Number Candles
Bougie Numéros
Zahlenkerzen
Velas Números



ref.	L (cm)		Bar Code	
786300N	9,50	12/288	8411922455670	Nº 0
786301N	9,50	12/288	8411922455687	Nº 1
786302N	9,50	12/288	8411922455694	Nº 2
786303N	9,50	12/288	8411922455700	Nº 3
786304N	9,50	12/288	8411922455717	Nº 4
786305N	9,50	12/288	8411922455724	Nº 5
786306N	9,50	12/288	8411922455731	Nº 6
786307N	9,50	12/288	8411922455748	Nº 7
786308N	9,50	12/288	8411922455755	Nº 8
786309N	9,50	12/288	8411922455762	Nº 9



Utensilios.

Professional.

ACERO INOXIDABLE 18/10. PLÁSTICO
STAINLESS STEEL 18/10. PLASTIC
ACIER INOXYDABLE 18/10. PLASTIQUE
ROSTFREIER STAHL 18/10. KUNSTSTOFF
AÇO INOXIDÁVEL 18/10. PLÁSTICO

Espátula Recta

Straight Spatula
Spatule Droite
Gerader Spatel
Espátula Reta



ref.	L (cm)	H (cm)	📦	Bar Code
737810	10	2	6/144	8411922440560
737815	15	3	6/144	8411922092158
737820	20	3	6/120	8411922092165
737825	25	3,50	6/96	8411922092172
737830	30	4	6/72	8411922092189

Espátula Acodada

Angled Spatula
Spatule Coudée
Eckspatel
Espátula Curva



ref.	L (cm)	H (cm)	📦	Bar Code
737910	10	2	6/144	8411922440577
737915	15	3	6/144	8411922092196
737920	20	3	6/120	8411922092202
737925	25	3,50	6/96	8411922092219
737930	30	4	6/72	8411922092226

Set 3 Espátulas Mini

Set 3 Mini Spatulas
Jeu 3 Spatules Mini
Set 3 Mini Spatel
Jogo 3 Espátulas Mini



ref.	L (cm)	H (cm)	📦	Bar Code
738000	10	2	6/48	8411922092233

Paleta Rectangular

Rectangular Palette
Palette Rectangulaire
Rechteckige Schaufel
Paleta Retangular



ref.	L (cm)	W (cm)	📦	Bar Code
738400	25	7	6/72	8411922093056

Paleta Triangular

Triangular Palette
Palette Triangulaire
Dreieckige Schaufel
Paleta Triangular



ref.	L (cm)	W (cm)	📦	Bar Code
738500	25	6	6/120	8411922093155

Paleta Rectangular XL

Rectangular Palette XL
Palette Rectangulaire XL
Rechteckige Schaufel XL
Paleta Retangular XL



ref.	L (cm)	W (cm)	📦	Bar Code
738450	32	12	6/36	8411922439922

Rasqueta

Scraper
Racloir
Schaber
Raspador



ref.	L (cm)	H (cm)	📦	Bar Code
738100	15	7,50	6/60	8411922092240

Rasqueta Triangular

Triangular Scraper
Racloir Triangulaire
Dreieckige Schaber
Raspador Triangular



ref.	L (cm)	W (cm)	📦	Bar Code
738300	25	10	6/96	8411922092950



Espátula Acodada Ecoprof

Ecoprof Angled Spatula
Spatule Coudée Ecoprof
Eckspatel Ecoprof
Espátula Curva Ecoprof



ref.	L (cm)		Bar Code
737910E	10	6/48	8411922448689
737915E	15	6/72	8411922448696
737920E	20	6/72	8411922448702
737925E	25	6/48	8411922448719
737930E	30	6/48	8411922448726

Espátula Recta Ecoprof

Ecoprof Straight Spatula
Spatule Droite Ecoprof
Gerader Spatel Ecoprof
Espátula Reta Ecoprof



ref.	L (cm)		Bar Code
737810E	10	6/48	8411922448634
737815E	15	6/72	8411922448641
737820E	20	6/72	8411922448658
737825E	25	6/48	8411922448665
737830E	30	6/72	8411922448672

Set 3 Espátulas Mini Ecoprof

Set 3 Ecoprof Mini Spatulas
Jeu 3 Spatules Mini Ecoprof
Set 3 Mini Spatel Ecoprof
Jogo 3 Espátulas Mini Ecoprof



ref.	L (cm)		Bar Code
738000E	10	6/36	8411922448733

Rasqueta Ecoprof

Ecoprof Scraper
Racloir Ecoprof
Schaber Ecoprof
Raspador Ecoprof



ref.	L (cm)		Bar Code
738100E	15	6/36	8411922448740

Paleta Rectangular Ecoprof

Ecoprof Rectangular Palette
Palette Rectangulaire Ecoprof
Rechteckige Schaufel Ecoprof
Paleta Retangular Ecoprof



ref.	L (cm)	W (cm)		Bar Code
738400E	25	7	6/36	8411922448764

Paleta Rectangular XL Ecoprof

Ecoprof Rectangular Palette XL
Palette Rectangulaire XL Ecoprof
Rechteckige Schaufel XL Ecoprof
Paleta Retangular Ecoprof XL



ref.	L (cm)	W (cm)		Bar Code
738450E	32	12	6/36	8411922448771

Rasqueta Triangular Estreha Ecoprof

Ecoprof Narrow Triangular Scraper
Racloir Triangulaire Étroit Ecoprof
Schmaler Dreieckliger Schaber Ecoprof
Raspador Triangular Estreito Ecoprof



ref.	L (cm)	W (cm)		Bar Code
738300E	25	10	6/48	8411922448757

Rasqueta Triangular Ancha Ecoprof

Wide Triangular Scraper
Grattoir triangulaire large
Breiter dreieckiger Schaber
Raspador triangular largo



ref.	L (cm)	W (cm)		Bar Code
687215E	23,50	15	6/36	8411922459616

Paleta Triangular Ecoprof

Ecoprof Triangular Pallete
 Palette Triangulaire Ecoprof
 Dreieckige Schaufel Ecoprof
 Paleta Triangular Ecoprof



ref.	L (cm)	W (cm)		Bar Code
738500E	25	6	6/48	8411922448788

Rasqueta Triangular Ancha Mango de Madera

Triangular Ancha Mango Wood Scraper
 Grattoir triangulaire en bois de manguier Ancha
 Dreieckiger Ancha Mango-Holzschaber
 Rascador Triangular de Madera de Mango Ancha



ref.	L (cm)	W (cm)		Bar Code
687215M	21	15	6/36	8411922459630

Utensilios.

Utensilios de Silicona.

SILICONA
 SILICONE
 SILICONE
 SILIKON
 SILICONE



Espátula-Cuchara Blueberry

Blueberry Spatula-Spoon
 Spatule-Cuillère Blueberry
 Spatel-Löffel Blueberry
 Espátula-Colher Blueberry



ref.	L (cm)		Bar Code
799230	27	6/72	8411922453478

Pincel Blueberry

Blueberry Brush
 Pinceau Blueberry
 Bürste Blueberry
 Pincel Blueberry



ref.	L (cm)		Bar Code
799240	26	6/72	8411922453485

Cuchara Blueberry

Spoon Blueberry
 Cuillère Blueberry
 Löffel Blueberry
 Colher Blueberry



ref.	L (cm)		Bar Code
799220	27,50	6/72	8411922453461

Espátula Blueberry

Blueberry Spatula
 Spatule Blueberry
 Spatel Blueberry
 Espátula Blueberry



ref.	L (cm)		Bar Code
799210	27	6/72	8411922453454

Pincel / Espátula (Bote 12+12 uds.)

Brush / Spatula (Container 12+12 pcs)
 Pinceau / Spatule (Pot 12+12 pcs)
 Bürste / Spatel (Dose 12+12 stk.)
 Escova / Espátula (Pote 12+12 uds.)



- Silicona
- Acero Inoxidable
- Silicone
- Stainless Steel

ref.	L (cm)		Bar Code
742700	32	24/96	8411922435566

Cuchara / Espátula (Bote 12+8 uds.)

Spoon / Spatula (Container 12+8 pcs)
Cuillère / Spatule (Pot 12+8 pcs)
Löffel / Spatel (Dose 12+8 stk.)
Colher / Espátula (Pote 12+8 uds.)



- Silicona
- Acero Inoxidable
- Silicone
- Stainless Steel



ref.	L (cm)		Bar Code
742601	26-28	20/80	8411922435559

Pincel / Pinza (Bote 10+10 uds.)

Brush / Tong (Container 10+10 pcs)
Pinceau / Pince (Pot 10+10 pcs)
Bürste / Zange (Dose 10+10 stk.)
Escova / Pinça (Pote 10+10 uds.)



- Silicona
- Acero Inoxidable
- Silicone
- Stainless Steel



ref.	L (cm)		Bar Code
742600	25-29	20/80	8411922435542

Espátula de Silicona

Silicone Spatula
Spatule Silicone
Silikonspatel
Espátula de Silicone



ref.	L (cm)		Bar Code
732500	30	12/72	8411922086560

Cuchara de Silicona

Silicone Spoon
Cuillère Silicone
Silikonlöffel
Colher de Silicone



ref.	L (cm)		Bar Code
732400	30	12/48/96	8411922086553

Espátula Repostería Silicona

Silicone Pastry Spatula
Spatule Pâtisserie Silicone
Silikongebäckspatel
Espátula de Pastelaria em Silicone



ref.	L (cm)	W (cm)		Bar Code
735300	30	5	12/48/96	8411922089011

Pincel de Silicona

Silicone Brush
Pinceau Silicone
Silikonbürste
Escova de Silicone



ref.	L (cm)		Bar Code
732600	30	12/48/96	8411922086577

Batidor de Silicona con Mango Inox

Silicone Whisk with Stainless Steel Handle
Fouet en Silicone avec Manche Inox
Silikon Schneebesen mit Edelstahlgriff
Batedor de Silicone com Cabo Inox



ref.	L (cm)		Bar Code
786800	25	12/96	8411922087574

Pinza Silicona

Silicone Tongs
Pince Silicone
Silikon-Zange
Pinça de Silicone



ref.	L (cm)		Bar Code
736300	30	12/72	8411922090369

Espátula Silicona Profesional Mango Inox

Professional Silicone Spatula Stainless Steel Handle
Spatule Professionnelle en Silicone Manche Inox
Professionell Silikon-Spatel Edelstahlgriff
Espátula Silicone Profissional com Cabo Inox



ref.	L (cm)		Bar Code
702026	26	12/120	8411922618266
702032	32	12/72	8411922618327
702036	36	6/36	8411922448917

Espátula Silicona Profesional

Professional Silicone Spatula
Spatule Professionnelle en Silicone
Professionell Silikon-Spatel
Espátula Silicone Profissional



ref.	L (cm)		Bar Code
702225	25	12/72	8411922451030
702236	36	12/72	8411922451047
702241	41	12/72	8411922451054

Espátula Silicona Grande con Mango Plástico

Large Silicone Spatula with Plastic Handle
Grande Spatule en Silicone avec Manche en Plastique
Großer Silikonspatel mit Kunststoffgriff
Espátula Grande de Silicone com Cabo de Plástico



ref.	L (cm)		Bar Code
752550	25,30	6/144	8411922071153

Pinzel Silicona Mango Plástico

Silicone Brush Plastic Handle
Pinceau Silicone Manche en Plastique
Silikonbürste Kunststoffgriff
Escova de Silicone Cabo de Plástico



ref.	L (cm)		Bar Code
751800	24	6/144	8411922071139

Espátula Plástico

Plastic Spatula
Spatule Plastique
Plastikspatel
Espátula de Plástico



ref.	L (cm)		Bar Code
756000	25	12/360	8411922600179

Espátula Silicona con Mango Inox

Silicone Spatula with Stainless Steel Handle
Spatule Silicone avec Manche Inox
Silikonspatel mit Edelstahlgriff
Espátula de Silicone com Cabo Inox



ref.	L (cm)		Bar Code
763900	30	6/96	8411922203110

Set 2 Espátulas Mini / Rebañabotes (Espátula + Cuchara)

Set 2 Mini Spatulas / Jar Scraper (Spatula + Spoon)
Jeu 2 Spatules Mini/ Racloir à Bocaux (Spatule + Cuillère)
Set 2 Mini-Spatel / Topfschaber (Spatel + Löffel)
Jogo 2 Mini Espátulas / Raspador de Frascos (Espátula + Colher)



ref.	L (cm)		Bar Code
748800	23	6/72	8411922438604

Utensilios.

Batidores.

ACERO INOXIDABLE
STAINLESS STEEL
ACIER INOXYDABLE
ROSTFREIER STAHL
AÇO INOXIDÁVEL



Batidor Mecánico

Hand Push Whisk
Fouet Mécanique
Handrührgerät
Batedor Mecânico



ref.	L (cm)		Bar Code
786725	25	6/72	8411922457896
786730	30	6/72	8411922457902

Batidor Mini Class

Class Mini Whisk
Fouet Mini Class
Mini-Schneebeesen Class
Batedor Mini Class



ref.	L (cm)		Bar Code
750515	15	6/72	8411922068887

Batidor Mini

Mini Whisk
Fouet Mini
Mini-Schneebeesen
Batedor Mini



ref.	L (cm)		Bar Code
750415	15	6/72/288	8411922068870

Batidor Inox 12 Varillas

Stainless Steel 12-Rod Whisk
Fouet Inox 12 Tiges
Edelstahl-Schneebeesen 12 Stäbe
Batedor Inox 12 Varetas



ref.	L (cm)		Bar Code
750225	25	6/60	8411922083217
750230	30	6/60	8411922083224
750235	35	6/60	8411922083231
750240	40	6/60	8411922083248

Batidor Mango Termosellado

Heat Sealed Whisk
Fouet Thermoscellé
Schneebeesen Heissversiegelter Griff
Batedor com Pega Termoselada



ref.	L (cm)		Bar Code
680125	25	6/24	8411922448832
680130	30	6/24	8411922448849
680135	35	6/24	8411922448856
680140	40	6/24	8411922448863

A > 6 VARILLAS / WIRES
B > 6 VARILLAS / WIRES
C > 9 VARILLAS / WIRES
D > 9 VARILLAS / WIRES

Utensilios.

Varios.

Rodillo de Amasar (Chapa de Acero Antiadherente)

Rolling Pin (Non-stick Steel Plate)
Rouleau de Pâtisserie (Tôle d'Acier Antiadhésive)
Nudelholz (Antihaft-Stahlplatte)
Rolo de Massa (Placa de Aço Antiaderente)



ref.	L (cm)		Bar Code
756700	45	6	8411922600223

Espátula para Crepes

Crepe Spatula
Spatule à Crêpes
Crêpe Spatel
Espátula para Crepes



ref.	L (cm)		Bar Code
798700	18	6/96	8411922433999
798714	14	6/96	8411922436129

Pala para Servir Tartas Inox

Cake Server
Pelle pour Servir Gâteaux
Schaufel zum Servieren von Torten
Pá para Servir Bolos



ref.		Bar Code
761500	6/120	8411922621877

Comprobador de Tartas

Cake Tester
Testeur de Cuisson pour Gâteaux
Kuchentester
Provador de Bolos



ref.	L (cm)		Bar Code
778000	16	6/48/576	8411922080551

Espátula Repostería Nylon

Pastry Spatula
Spatule Pâtisserie
Bäckspatel
Espátula Pastelaria



ref.	L (cm)		Bar Code
758000	31	12/144	8411922600353

Pincel Profesional

Professional Pastry Brush
Pinceau Professionnel
Professioneller Backpinsel
Pincel Pasteleiro Profissional



ref.	W (cm)	L (cm)		Bar Code
685602	2,50	23	6/480	8411922458541
685605	5	23	6/384	8411922458558
685607	7,50	23	6/288	8411922458565

Pincel para Repostería Plástico

Plastic Pastry Brush
Pinceau à Pâtisserie en Plastique
Plastik-Backpinsel
Pincel de Pastelaria de Plástico



ref.		Bar Code
757100	6/144	8411922600261

Bolas para Repostería

Pie weights
Boules pour Pâtisserie
Kuchengewichte
Bolas para Pastelaria



ref.	Kg		Bar Code
728502	0,25	6/24	8411922085037

Tamizadores.

ACERO INOXIDABLE 18/10
STAINLESS STEEL 18/10
ACIER INOXYDABLE 18/10
ROSTFREIER STAHL 18/10
AÇO INOXIDÁVEL 18/10

Tamizador de Malla Inox

Stainless Steel Mesh Sieve
Tamis à Maille Inox
Maschensieb aus Edelstahl
Peneira de Rede Inox



ref.	Ø (cm)		Bar Code
704216	16	4/48	8411922069891
704220	20	4/48	8411922069907
704225	25	4/48	8411922069914

Tamizador

Sieve
Tamis
Sieb
Peneira



ref.	Ø (cm)		Bar Code
761000	8,50	6/96	8411922621822

Tamizador Bistrot

Bistrot Sieve
Tamis Bistrot
Sieb Bistrot
Peneira Bistrot



ref.	Ø (cm)		Bar Code
761003	10	6/60	8411922080117

Espolvoreador de Malla

Mesh Shaker
Boîte à Saupoudrer en Maille
Mesh-Streuer
Polvilhador Malha



ref.	Ø (cm)	H (cm)		Bar Code
742200	7	10	6/96	8411922435405

Espolvoreador

Duster
Boîte à Saupoudrer
Sprinkler
Polvilhador



ref.	Lts		Bar Code
757400	0,25	6/96	8411922600285

Medidores.

Vaso de Medidas

Measuring Cup
Verre Mesureur
Messbecher
Copo Medidor



- **Borosilicato**
- Borosilicate



ref.	∅ (cm)	H (cm)	Lts	∅	Bar Code
481208	10	15	0,80	6/36	8411922449396
481210	11	15	1	6/24	8411922449402

Jarra de Medidas Kristall

Kristall Measuring Jug
Jar droit Mesureur Kristall
Kristall Straight Messbecher
Copo Medidor Kristall



- **Vidrio**
- Glass



ref.	Lts	∅	Bar Code
481105	0,50	6	8411922087024
481110	1	6	8411922087031

NEW

Jarra Medidas con Asa

Straight Measuring Jug with Handle
Pichet Gradu  avec Anse
Gerade Messbecher mit Henkel
Jarro de Medi o com Asa



- **Borosilicato**
- Borosilicate



ref.	∅ (cm)	H (cm)	Lts	∅	Bar Code
481305	8	14	0,50	3/6/24	8411922475036
481310	10	16,50	1	3/6/12	8411922475043

Jarra de Medidas

Measuring Jug
Pichet Mesureur
Messbecher
Jarro de Medi o



- **Pl stico**
- Plastic



ref.	Lts	∅	Bar Code
765200	0,60	12/48	8411922206364

Medidor-Racionador Multiple

Multiple Measurer / Portioner
Mesureur - Doseur Multiple
Messbecher, Mehrfach Skaliert - Skalierbar
Medidor - Porcionador M ltiplo



- **Ecozen**
- **Pl stico**
- **Personalizable**
- Ecozen
- Plastic
- Customizable



ref.	Lts	∅ (cm)	H (cm)	∅	Bar Code
787410	0,50	10	14,50	1/6/24	8411922449228

Medidor Inox

Stainless Steel Measurer
 Measure Inox
 Messgerät Inox
 Medidor Inox



ref.	ml		Bar Code
681601	100	12/120	8411922455564

Set 4 Cucharas de Medidas

Set 4 Measuring Spoons
 Jeu 4 Cuillères de Mesure
 Set 4 Messlöffel
 Jogo 4 Colheres Medidoras



- Nylon
- Acero Inoxidable
- Nylon
- Stainless Steel

1, 1/2 TSP

1, 1/2 TBSP

ref.	L (cm)	W (cm)		Bar Code
736800	14	4,50	6/144	8411922091809

Set 4 Cazos de Medidas

Set 4 Measuring Spoons
 Jeu 4 Récipients de Mesure
 Set 4 Messlöffel
 Jogo 4 Caçarolas Medidoras



- Nylon
- Acero Inoxidable
- Nylon
- Stainless Steel

1, 1/2, 1/3, 1/4 CUP

ref.	L (cm)	W (cm)		Bar Code
736900	19	8,50	6/60	8411922091816

Set 4 Cucharas de Medidas Inox

Set 4 Stainless Steel Measuring Spoons
 Jeu 4 Cuillères de Mesure Inox
 Set 4 Messlöffel aus Edelstahl
 Conjunto 4 Colheres de Medidas Inox

1, 1/2 TSP

1, 1/2 TBSP



ref.		Bar Code
701400	6/12/144	8411922612004

Set 4 Cazos de Medidas Inox

Set 4 Stainless Steel Measuring Cups
 Jeu 4 Récipients de Mesure Inox
 Set 4 Edelstahl Messbecher
 Set 4 Caçarolas Medidoras Inox



59 - 79 - 118 - 236 ML

1/4 - 1/3 - 1/2 - 1 CUP

ref.	Ø (cm)		Bar Code
701910	5-6-7-8,50	6/36	8411922449556



Cápsulas Repostería (100 uds.)

Baking Cups
Capsules à Pâtisserie
Gebäck-Kapseln
Cápsulas Pastelaria



ref.	Ø (cm)	H (cm)	📦	Bar Code
735900	7,50	4	12/72	8411922090147

Cápsulas Repostería Lunares (50 + 50 uds.)

Polka Dots Baking Cups
Capsules à Pâtisserie Pois
Gebäck-Kapseln Tupfen
Cápsulas Pastelaria Bolinhas



ref.	Ø (cm)	H (cm)	📦	Bar Code
735903	7,50	4	12/72	8411922090178

Cápsulas Repostería (50 + 50 uds.)

Baking Cups
Capsules à Pâtisserie
Gebäck-Kapseln
Cápsulas Pastelaria



ref.	Ø (cm)	H (cm)	📦	Bar Code
735901	7,50	4	12/72	8411922090154

Cápsulas Repostería Lunares (50 + 50 uds.)

Polka Dots Baking Cups
Capsules à Pâtisserie Pois
Gebäck-Kapseln Tupfen
Cápsulas Pastelaria Bolinhas



ref.	Ø (cm)	H (cm)	📦	Bar Code
735904	7,50	4	12/72	8411922090185

Cápsulas Repostería Primavera (50 + 50 uds.)

Spring Baking Cups
Capsules à Pâtisserie Printemps
Gebäck-Kapseln Frühjahr
Cápsulas Pastelaria Primavera



ref.	Ø (cm)	H (cm)	📦	Bar Code
735907	7,50	4	12/72	8411922090215

Cápsulas Repostería Cuadros (50 + 50 uds.)

Squares Baking Cups
Capsules à Pâtisserie Carreaux
Gebäck-Kapseln Quadrate
Cápsulas Pastelaria Quadrados



ref.	Ø (cm)	H (cm)	📦	Bar Code
735909	7,50	4	12/72	8411922090239

Cápsulas Repostería Fiesta (50 + 50 uds.)

Party Baking Cups
Capsules à Pâtisserie Fête
Gebäck-Kapseln Partei
Cápsulas Pastelaria Festa



ref.	Ø (cm)	H (cm)	📦	Bar Code
735908	7,50	4	12/72	8411922090222

Cápsulas Repostería Rayas (50 + 50 uds.)

Striped Baking Cups
Capsules à Pâtisserie Rayures
Gebäck-Kapseln Streifen
Cápsulas Pastelaria Listras



ref.	Ø (cm)	H (cm)	📦	Bar Code
735905	7,50	4	12/72	8411922090192

Cápsulas Repostería Princesa (50 + 50 uds.)

Baking Cups Princess
Capsules à Pâtisserie Princesse
Gebäck-Kapseln Prinzessin
Cápsulas Pastelaria Princesa



ref.	Ø (cm)	H (cm)	📦	Bar Code
735913	7,50	4	12/72	8411922433593

Cápsulas Repostería Baby (50 + 50 uds.)

Baking Cups Baby
Capsules à Pâtisserie Baby
Gebäck-Kapseln Baby
Cápsulas Pastelaria Baby



ref.	Ø (cm)	H (cm)	📦	Bar Code
735914	7,50	4	12/72	8411922433609

Set Cápsulas Navidad (100 uds.)

Set Christmas Baking Cups
Jeu Capsules à Pâtisserie Noël
Set Gebäck-Kapseln Weihnachten
Jogo Cápsulas Pastelaria Natal



ref.	Ø (cm)	📦	Bar Code
735911	7,50	12/72	8411922091991

Set Cápsulas Pascua (100 uds.)

Set Easter Baking Cups
Jeu Capsules à Pâtisserie Pâques
Set Gebäck-Kapseln Ostern
Jogo Cápsulas Pastelaria Páscoa



ref.	Ø (cm)	📦	Bar Code
735912	7,50	12/72	8411922092004

Cápsulas Repostería Mini (50 + 50 uds.)

Mini Baking Cups
Mini Capsules à Pâtisserie
Mini Gebäck-Kapseln
Mini Cápsulas Pastelaria



ref.	Ø (cm)	H (cm)	📦	Bar Code
737200	4,50	2,50	12/144	8411922092042

Cápsulas Madalena Papel (75 uds.)

Paper Baking Cups
Barquettes à Pâtisserie en Papier
Papier-Backförmchen
Cápsulas Madalena Papel



ref.	Ø (cm)	📦	Bar Code
701600	6,50	12/240	8411922614008

Cápsulas Bombón (100 uds.)

Candy Cases
Moules Praliné
Pralinenförmchen
Capsulas Bombom



ref.	∅ (cm)		Bar Code
764200	2,50	12/144	8411922203806

Cápsulas Bombón Papel (48 uds.)

Paper Candy Cases
Moules Praliné
Papier Pralinenförmchen
Capsulas Bombom Papel



ref.	∅ (cm)		Bar Code
706600	4	1/12/240	8411922072846

Cápsulas Bombón Lunares (36 uds.)

Dots Candy Case
Moule Praliné Pois
Bonbon-Kapsel Tupfen
Cápsula Bombóm Bolinhas



ref.	∅ (cm)	H (cm)		Bar Code
737700	3	1,50	12/144	8411922092134

Set Cápsulas Halloween (96 + 24 uds.)

Set Halloween Baking Cups
Jeu Capsules à Pâtisserie Halloween
Set Gebäck-Kapseln Halloween
Jogo Cápsulas Pastelaria Halloween



ref.	∅ (cm)		Bar Code
737000	7,50	12/48	8411922092028

Cápsulas Bombón Corazón (36 uds.)

Heart Candy Case
Moule Praliné Cœur
Bonbon-Kapsel Herz
Cápsula Bombóm Coração



ref.	L (cm)	H (cm)		Bar Code
737600	3	1,50	12/144	8411922092127

Cápsulas Redondas Colores (10+10 uds.)

Round Baking Cups Colors
Capsules Rondes Couleurs
Runde Kapseln Farben
Cápsulas Redondas Cores



ref.	∅ (cm)	H (cm)		Bar Code
737401	6	5,50	6/36	8411922092073

Cápsula Madalena Redonda (50 uds.)

Round Muffin Baking Cup
Barquette à Pâtisserie Rond
Runde Muffin-Backförmchen
Cápsula Madalena Redonda



ref.	∅ (cm)	H (cm)		Bar Code
729307	7	3,50	12/48	8411922085853
729308	8	4,50	12/48	8411922085860

Cápsulas Muffin (50 uds.)

Muffin Baking Cups
Capsules à Pâtisserie Muffin
Muffin Gebäck-Kapseln
Cápsulas Muffin



ref.	∅ (cm)	H (cm)		Bar Code
738200	7,50	4	6/72	8411922092301

Envoltorio para Cupcake Telararaña (10 uds.)

Cupcake Wrapper Spider Web
Emballage de Cupcakes Toile d'Araignée
Wrapper für Cupcake Spinnennetz
Invólucro para Cupcake Teia de Aranha



ref.	∅ (cm)		Bar Code
736003	21x5	12/72	8411922092011

Cápsula Bombón (100 uds.)

Candy Case
Moule Praliné
Bonbon-Kapsel
Cápsula Bombóm



ref.	∅ (cm)	H (cm)		Bar Code
729204	4	2	12/48	8411922085846

Envoltorio para Cupcake Flores Azules (10 uds.)

Cupcake Wrapper Blue Flowers
Emballage de Cupcakes Fleurs Bleues
Wrapper für Cupcake Blaue Blumen
Invólucro para Cupcake Flores Azuis



ref.	∅ (cm)		Bar Code
736001	5+8	12/72	8411922090260

Envoltorio para Cupcake Mariposas (10 uds.)

Cupcake Wrapper Butterflies
Emballage de Cupcakes Papillons
Wrapper für Cupcake Schmetterlinge
Invólucro para Cupcake Borboletas



ref.	∅ (cm)		Bar Code
736002	5+8	12/72	8411922090277

Envoltorio para Cupcake Flores Rosas (10 uds.)

Cupcake Wrapper Pink Flowers
Emballage de Cupcakes Fleurs Roses
Wrapper für Cupcake Rosa Blumen
Invólucro para Cupcake Flores Rosas



ref.	∅ (cm)		Bar Code
736000	5+8	12/72	8411922090253

Cápsulas Rectangulares Lunares (12 uds.)

Rectangular Baking Cups Polka Dots
Capsules Rectangulaires Pois
Rechteckige Kapseln Tupfen
Cápsulas Retangulares Bolinhas



ref.	L (cm)	H (cm)		Bar Code
737450	9,50	3,20	12/144	8411922092097

Set 6 Moldes Madalena Silicona

Silicone Muffin Molds
Barquettes Madeleine Silicone
Silikon-Muffin-Förmchen
Formas para Madalena de Silicone

- Silicona
- Silicone



ref.	∅ (cm)	H (cm)		Bar Code
752400	7	3,50	6/144	8411922071269

Set 6 Cápsulas Mini

Mini Capsules
Capsules Mini
Mini-Kapseln
Mini Cápsulas

- Silicona
- Silicone



ref.	∅ (cm)	H (cm)		Bar Code
872400	5	2	6/192	8411922091922

Set 4 Cápsulas para Cupcake

Cupcake Capsules
Capsules pour Cupcake
Cupcake-Kapseln
Cápsulas para Cupcake



- **Silicona**
- Silicone



ref.	∅ (cm)	H (cm)	📦	Bar Code
871406	6,50	3,80	6/24	8411922087918



Bandejas y Blondas.

PAPEL
PAPER
PAPIER
PAPIER
PAPEL

Blonda Redonda (10 uds.)

Round Doilie
Napperon Rond
Runde Spitzendecke
Naperon Redondo



ref.	∅ (cm)	📦	Bar Code
701712	12	12/96	8411922072815
701726	26	12/96	8411922085686
701734	34	12/96	8411922085709

Blonda Rectangular (10 uds.)

Rectangular Doilie
Napperon Rectangulaire
Rechteckig Spitzendecke
Naperon Rectangular



ref.	L (cm)	W (cm)	📦	Bar Code
701830	39	30	12/96	8411922085730

Bandeja Redonda

Round Tray
Plateau Rond
Runde Schale
Bandeja Redonda



ref.	∅ (cm)	📦	Bar Code
728923	23	12/24	8411922085747
728927	27	12/24	8411922085761
728932	32	12/24	8411922085754

Bandeja Rectangular

Rectangular Tray
Plateau Rectangulaire
Rechteck Schale
Bandeja Rectangular



ref.	L (cm)	W (cm)	📦	Bar Code
729011	36	11	12/24	8411922085778
729021	28	21	12/24	8411922085785
729026	34	26	12/24	8411922085792
729029	38	29	12/24	8411922085808

5 Bandejas + 5 Blondas Redondas

5 Trays + 5 Round Doilies
 5 Plateaux + 5 Napperons Ronds
 5 Tabletts + 5 Runde Deckchen
 5 Bandejas + 5 Naperons Redonds



ref.	∅ (cm)		Bar Code
729500	32+34	12/24	8411922085815

5 Bandejas + 5 Blondas Rectangulares

5 Trays + 5 Rectangular Doilies
 5 Plateaux + 5 Napperons Rectangulaires
 5 Tabletts + 5 Rechteckige Deckchen
 5 Bandejas + 5 Naperons Rectangulares



ref.	L (cm)	W (cm)		Bar Code
729501	34+39	26+30	12/24	8411922085822

3 Bandejas + 3 Blondas Rectangulares Silver

3 Trays + 3 Rectangular Doilies Silver
 3 Plateaux + 3 Napperons Rectangulaires Silver
 3 Tabletts + 3 Rechteckige Deckchen Silver
 3 Bandejas + 3 Naperons Rectangulares Silver



ref.	L (cm)	W (cm)		Bar Code
729521	30+26	39+34	12/24	8411922089080

3 Bandejas + 3 Blondas Rectangulares Gold

3 Trays + 3 Rectangular Doilies Gold
 3 Plateaux + 3 Napperons Rectangulaires Gold
 3 Tabletts + 3 Rechteckige Deckchen Gold
 3 Bandejas + 3 Naperons Rectangulares Gold



ref.	L (cm)	W (cm)		Bar Code
729511	30+26	39+34	12/24	8411922089066

3 Bandejas + 3 Blondas Redondas Silver

3 Trays + 3 Round Doilies Silver
 3 Plateaux + 3 Napperons Ronds Silver
 3 Tabletts + 3 Runde Deckchen Silver
 3 Bandejas + 3 Naperons Redonds Silver



ref.	∅ (cm)		Bar Code
729520	34+32	12/24	8411922089073

3 Bandejas + 3 Blondas Redondas Gold

3 Trays + 3 Round Doilies Gold
 3 Plateaux + 3 Napperons Ronds Gold
 3 Tabletts + 3 Runde Deckchen Gold
 3 Bandejas + 3 Naperons Redonds Gold



ref.	∅ (cm)		Bar Code
729510	34+32	12/24	8411922089059

3 Bandejas + 3 Blondas Plum Cake

3 Trays + 3 Plum Cake Doilies
 3 Plateaux + 3 Napperons Plum Cake
 3 Tabletts + 3 Pflaumenkuchen Deckchen
 3 Bandejas + 3 Naperons Plum Cake



ref.	L (cm)	W (cm)		Bar Code
729502	36 36	11 14	12/24	8411922091588

Caja para 4 Cupcakes (2 uds.)

Box for 4 Cupcakes
Boîte pour 4 Cupcakes
Schachtel für 4 Cupcakes
Caixa para 4 Cupcakes



- Papel
- Paper

ref.	L (cm)	W (cm)	H (cm)		Bar Code
737504	16	16	7,50	12/144	8411922092103

Caja para Cookies-Bombones Casita (4 uds.)

Box for Cookies and Chocolates Cottage
Boîte pour Cookies et Chocolates Petite Maison
Schachtel für Kekse und Pralinen Häuschen
Caixa para Biscoitos-Bombons Casinha



ref.	W (cm)		Bar Code
739500	3	12/72	8411922433616

Fondant.

Fondant.

Utensilios para Fondant.

Tapete de Repostería con Medidas

Pastry Mat with Measurements
Tapis a Pâtisserie avec Mesures
Backmatte mit Maßnahmen
Tapete para Forno com Medidas

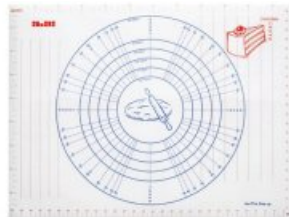

ref.	L (cm)	W (cm)		Bar Code
738600	61	45,50	1/6/18	8411922093254

Rodillo Milrayas

Stripe Roller Pin
Rouleau Imprimé à Rayures
Nudelholz mit Streifenprägung
Rolo de Milrayas



- Nylon
- Nylon

ref.	L (cm)	H (cm)		Bar Code
788300	14	2,50	6/24	8411922088472

Anillas Niveladoras Pequeñas

Mini Levelling Rings
Anneaux de Nivelage Mini
Kleine Nivelliererringe
Anéis de Nivelamento Pequenos



- Silicona
- Silicone

ref.	H (mm)		Bar Code
792050	1,6+3,20	6/192	8411922091878

Cuchillo para Fondant

Fondant Knife
Couteau Fondant
Fondant-Messer
Faca para Fondant



- Plástico
- Plastic

ref.	L (cm)		Bar Code
754500	27	6/144	8411922087239

Tablillas Niveladoras (6 uds.)

Fondant Icing Leveler
Planches à Niveler
Nivellierbretter
Tábuas de Nivelamento



- Plástico
- Plastic



ref.	L (cm)	H (cm)		Bar Code
787310	35	2+4+8	1/6/48	8411922454369

Tablillas Niveladoras (6 uds.)

Fondant Icing Leveler
Planches à Niveler
Nivellierbretter
Tábuas de Nivelamento

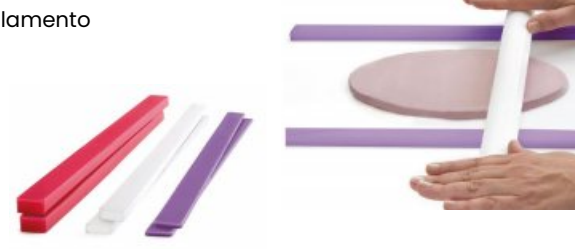

- Plástico
- Plastic



ref.	L (cm)	H (mm)		Bar Code
787300	35	3+5+10	1/6/36	8411922087741

Set 6 Pinceles para Repostería

Set 6 Pastry Brushes
Jeu 6 Pinceaux à Pâtisserie
Set 6 Backpinseln
Jogo 6 pincéis de Pastelaria



- Plástico
- Plastic

ref.	L (cm)		Bar Code
791200	22	6/96	8411922090659

Juego 12 Estecas para Modelar

Set 12 Icing Modelling Tools
Jeu 12 Outils de Modelage
Set 12 Modellierstäbchen
Jogo 12 Palitos de Modelação



- Plástico
- 24 formas
- Plastic
- 24 models



ref.	L (cm)		Bar Code
752900	14	1/6/48	8411922084238

Pinzas para Fondant (10 uds.)

Fondant Tong
Pinces pour Fondant
Fondant-Zange
Pinças para Fondant



- Plástico
- Plastic

ref.	L (cm)		Bar Code
789200	10	6/72	8411922089981

Pinzas para Fondant Dentadas (10 uds.)

Toothed Fondant Tong
Pinces pour Fondant Dentée
Gezahnte Fondant-Zange
Pinças para Fondant Dentadas



- Plástico
- Plastic

ref.	L (cm)		Bar Code
789250	10	6/72	8411922091854



Molde Chocolate Letras y Números

Chocolate Mold Letters and Numbers
Moule Chocolat Lettres et Numéros
Schokoladen Form Buchstaben & Zahlen
Forma Chocolate Letras e Números



- **Silicona**
- Silicone

ref.	L (cm)	W (cm)		Bar Code
871300	24	16	6/72	8411922086942

Molde 3D Orlas

3D Trims Mold
Moule 3D Bordures
Borte 3D Form
Forma 3D Orlas



- **Silicona**
- Silicone

ref.	L (cm)	W (cm)	H (cm)		Bar Code
872207	14,50	7	1	1/6/144	8411922090093

Molde 3D Marcos

3D Marcos Mold
Moule 3D Marcos
Rahmen 3D Form
Forma 3D Molduras



ref.	L (cm)	W (cm)	H (cm)		Bar Code
872208	17	8,30	1	1/6/144	8411922090109

Molde 3D Cruces

3D Crosses Mold
Moule 3D Croix
Kreuze 3D Form
Forma 3D Cruzes



ref.	L (cm)	W (cm)	H (cm)		Bar Code
872209	12,50	3,50	1	1/6/144	8411922090116

Molde 3D Bebé

3D Baby Mold
Moule 3D Bébé
Baby 3D Form
Forma 3D Bebé

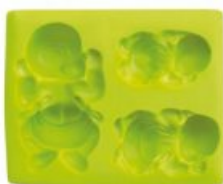

ref.	L (cm)	W (cm)	H (cm)		Bar Code
872201	8	6,50	1,50	1/6/72	8411922089783

Molde 3D Botones

3D Buttons Mold
Moule 3D Boutons
Knopf3D Form
Forma 3D Botões



ref.	L (cm)	W (cm)	H (cm)		Bar Code
872204	11	5,70	1	1/6/72	8411922089813

Molde 3D Ángel

3D Angel Mold
Moule 3D Ange
Engel 3D Form
Forma 3D Anjo



- **Silicona**
- Silicone

ref.	L (cm)	W (cm)	H (cm)		Bar Code
872206	9,60	6,20	1,70	1/6/72	8411922089837

Molde 3D Camafeos Dama

3D Lady Cameos Mold
Moule 3D Camées Dame
Dame-Kameen 3D Form
Forma 3D Camafeu Senhora



- **Silicona**
- Silicone

ref.	L (cm)	W (cm)	H (cm)		Bar Code
872202	12	8,50	0,80	1/6/72	8411922089790

Molde 3D Perlas

3D Pearls Mold
Moule 3D Perles
Perlen 3D Form
Forma 3D Pérolas



- **Silicona**
- Silicone

ref.	L (cm)	W (cm)		Bar Code
872210	15	3,50	1/6/96	8411922090420

Molde 3D Flores

3D Flowers Mold
Moule 3D Fleurs
Blumen 3D Form
Forma 3D Flores



- **Silicona**
- Silicone

ref.	L (cm)	W (cm)	H (cm)		Bar Code
872203	11	10	1,50	1/6/72	8411922089806

Molde 3D Flor + Hoja + Cortador

Mold 3D Flower + Leaf + Cutter
Moule 3D Fleur + Feuille + Cutter
Förmchen 3D Blume + Blatt + Ausstecher
Forma 3D Flor + Folha + Cortador



- **Plástico**
- Plastic

ref.	W (cm)		Bar Code
789100	4,5+3,5	6/144	8411922089974

Minisellos para Huellas Fondant

Footprints Mini-Stamps Fondant
Mini-Timbres Empreintes Fondant
Mini-Fondant-Fingerabdruck-Stempel
Mini Carimbos para Pegadas Fondant



- **Plástico**
- **Silicona**
- Plastic
- Silicone

ref.	Ø (cm)		Bar Code
789600	2,5+1,5	6/144	8411922090079

Set 3 Cortadores con Expulsor Blossom

Set 3 Blossom Cutters with Ejector
Jeu 3 Emporte-Pièces avec Pousoir Blossom
Set 3 Ausstecher mit Ausformhilfe Blossom
Jogo 3 Cortadores com Expulsor Blossom



ref.	W (cm)		Bar Code
788402	0,6+0,7+0,8	6/24	8411922088496

Set 3 Cortadores con Expulsor Estrella

Set 3 Star Cutters with Ejector
Jeu 3 Emporte-Pièces avec Pousoir Étoile
Set 3 Ausstecher mit Ausformhilfe Stern
Jogo 3 Cortadores com Expulsor Estrela



ref.	W (cm)		Bar Code
788403	0,7+1,0+1,2	6/24	8411922088502

Set 3 Cortadores con Expulsor Cuadrado

Set 3 Square Cutters with Ejector
Jeu 3 Emporte-Pièces avec Pousoir Carrés
Set 3 Ausstecher mit Ausformhilfe Quadratisch
Jogo 3 Cortadores com Expulsor Quadrado



ref.	W (cm)		Bar Code
788405	0,6+1+1,5	6/24	8411922089844

Set 4 Cortadores con Expulsor Margarita

Set 4 Daisy Cutters with Ejector
Jeu 4 Emporte-Pièces avec Pousoir Marguerite
Set 4 Ausstecher mit Ausformhilfe Gänseblümchen
Jogo 4 Cortadores com Expulsor Margarida



ref.	W (cm)		Bar Code
788406	1,4+2+2,7+3,5	6/144	8411922089851

Set 3 Cortadores con Expulsor Redondos

Set 3 Round Cutters with Ejector
Jeu 3 Emporte-Pièces avec Pousoir Ronds
Set 3 Ausstecher mit Ausformhilfe Rund
Jogo 3 Cortadores com Expulsor Redondo



ref.	∅ (cm)		Bar Code
788407	0,6+1+1,3	6/24	8411922089868

Set 3 Cortadores con Expulsor Corazón

Set 3 Heart Cutters with Ejector
Jeu 3 Emporte-Pièces avec Pousoir Coeur
Set 3 Ausstecher mit Ausformhilfe Herz
Jogo 3 Cortadores com Expulsor Coração



ref.	W (cm)		Bar Code
788408	0,6+1+1,3	6/24	8411922089875

Set 3 Cortadores con Expulsor Nubes

Set 3 Cloud Cutters with Ejector
Jeu 3 Emporte-Pièces avec Poussoir Nuages
Set 3 Ausstecher mit Ausformhilfe Wolken
Jogo 3 Cortadores com Expulsor Nuvens



ref.	W (cm)		Bar Code
788409	1,3+2+3	6/144	8411922090048

Set 3 Cortapastas con Expulsor Copo de Nieve

Set 3 Snowflake Dough Cutters with Ejector
Jeu 3 Emporte-Pièces avec Poussoir Flocon de Neige
Set 3 Ausstecher mit Ausformhilfe Schneeflocke
Jogo 3 Cortadores com Expulsor Flocos de Neve



ref.	W (cm)		Bar Code
788411	2,5+4+5,5	6/72	8411922433982

Fondant.

Bases para Fondant.

PAPEL CORRUGADO
CORRUGATED PAPER
PAPIER ONDULÉ
GEWELLTES PAPIER
PAPEL CANELADO

Base para Fondant Redonda

Round Base for Fondant
Base Ronde pour Fondant
Runder Fondant-Boden
Base de Fondant Redonda

ref.	Ø (cm)	H (cm)		Bar Code
787020	20	1,20	6/24	8411922087604
787025	25	1,20	6/24	8411922087611
787030	30	1,20	6/24	8411922087628
787035	35	1,20	6/24	8411922087635
787040	40	1,20	6/24	8411922087642
787045	45	1,20	6/24	8411922087659



Base para Fondant Cuadrada

Square Base for Fondant
Base Carrée pour Fondant
Quadratischer Fondant-Boden
Base de Fondant Cuadrada

ref.	L (cm)	W (cm)	H (cm)		Bar Code
787125	25	25	1,20	6/24	8411922087673
787130	30	30	1,20	6/24	8411922087680
787135	35	35	1,20	6/24	8411922087697
787140	40	40	1,20	6/24	8411922087703
787145	45	45	1,20	6/24	8411922087710



Base para Fondant Rectangular

Rectangular Base for Fondant
Base Rectangulaire pour Fondant
Rechteckiger Fondant-Boden
Base de Fondant Rectangular

ref.	L (cm)	W (cm)	H (cm)		Bar Code
787225	35	25	1,20	6/24	8411922087727
787230	40	30	1,20	6/24	8411922087734



Anodized Aluminium.

ALUMINIO ANODIZADO
ANODIZED ALUMINUM
ALUMINIUM ANODISÉ
ELOXIERTES ALUMINIUM
ALUMÍNIO ANODIZADO



Molde Redondo Extra Alto

Round Extra Deep Cake Pan
Moule Rond Extra Haut
Extra Hohe Runde Backform
Forma Redonda Extra Alta



ref.	∅ (cm)	H (cm)	Lts	📦	Bar Code
815110	10	10	0,80	6	8411922089431
815115	15	10	1,80	6	8411922089448
815120	20	10	3,20	6	8411922089455
815125	25	10	5	6	8411922089462
815130	30	10	7,30	6	8411922089479
815135	35	10	10	6	8411922089486

Molde Cuadrado Extra Alto

Square Extra Deep Cake Pan
Moule Carré Extra Haut
Extra Hohe Quadratische Backform
Forma Quadrada Extra Alta



ref.	L (cm)	H (cm)	Lts	📦	Bar Code
815212	12,50	10	1,60	6	8411922089493
815215	15	10	2,30	6	8411922089509
815220	20	10	4,10	6	8411922089516
815225	25	10	6,50	6	8411922089523
815230	30	10	9,30	6	8411922089530

Molde Redondo Alto

Round Deep Cake Pan
Mould Rond Profond
Hohe Runde Backform
Forma Redonda Alta



ref.	∅ (cm)	H (cm)	Lts	📦	Bar Code
815030	30	7,60	5,50	6	8411922089417

Molde Redondo Extra Alto Móvil

Round Extra Deep Loose Bottom Cake Pan
Moule Rond Extra Haut Amovible
Extra Hohe Runde Abnehmbar Backform
Forma Redonda Extra Alta Fundo Móvel



ref.	∅ (cm)	H (cm)	📦	Bar Code
815715	15	10	6	8411922449594
815720	20	10	6	8411922449600
815725	25	10	6	8411922449617
815730	30	10	6	8411922452112

Molde Desmontable Alto

Springform Deep Mold
Moule Démontable Haut
Hohe Springform
Forma Desmontável Alta



ref.	∅ (cm)	H (cm)	📦	Bar Code
815320	20	10	6	8411922438628

Molde Cake

Cake Mold
Moule Cake
Eloxierte Kastenform
Forma Bolo Inglês



ref.	L (cm)	W (cm)	H (cm)	📦	Bar Code
815425	25	10	7,50	6	8411922440065

Molde para Pan Inglés

English Bread Mold
Moule Pain Anglais
Englische Brotbackform
Forma para Pão Inglês

ref.	L (cm)	W (cm)	H (cm)		Bar Code
815520	19	10,50	11,50	3/6	8411922440072
815634	34,50	12	12,50	3/6	8411922441895



Antiadherentes.

Tapete para Horno

Oven Mat
Tapis pour four
Backmatte
Tapete para Forno



- Silicona
- Silicone



ref.	L (cm)	W (cm)		Bar Code
865000	40	30	6/48	8411922077247
865005	60	40	2/6/24	8411922474343

Tapete para Horno Microperforado

Microperforated Oven Mat
Tapis de Four Micro-Perforé
Mikroperforierte Backmatte
Tapete para Forno Microperforado



- Silicona
- Silicone



ref.	L (cm)	W (cm)		Bar Code
865050	40	30	6/48	8411922453331

Papel de Horno (20 uds.)

Baking Paper
Papier Four
Backpapier
Papel para Forno



- Pre-cortadas,
- pre-cut



ref.	L (cm)	W (cm)		Bar Code
200742	42	38	1/24	8411922438710

Papel de Horno

Baking Paper
Papier Four
Backpapier
Papel para Forno



- Papel
- Paper



ref.	L (cm)	W (cm)		Bar Code
200730	1000	29	1/24	8411922069228

Lámina Antiadherente 40x33cm

Non-Stick Sheet 40x33cms
Film Anti-Adhérent 40x33cm
Antihaft Folie 40x33cm
Folha Antiaderente 40x33cm



- **Fiberglass**
- **Recubrimiento Antiadherente**
- **Utilizable cientos de veces por ambas caras**
- Fiberglass
- Non-Stick Coating
- Can be used on both sides hundreds of times



ref.	L (cm)	W (cm)		Bar Code
200840	40	33	6/48	8411922073126

Spray Desmoldeante Antiadherente

Non-Stick Release Spray
Spray Démoulant Anti-Adhérent
Antihaft-Formtrennspray
Spray Antiaderente para Desenformar



- **Permite un fácil desmoldeo de pasteles, bizcochos, madalenas, galletas, etc**
- Enables an easy demoulding of cakes, biscuits, muffins, cookies, etc

ref.	Lts		Bar Code
746300	0,25	1/6	8411922436846



Repostería

Café y Té.



Coffee & Tea

Cafétéria

Kaffee & Tee

Cafetaria



<u>Cafeteras Express</u>	193
<u>Cafeteras Émbolo</u>	199
<u>Hervidores</u>	199
<u>Teteras Árabes</u>	201
<u>Teteras Cerámicas</u>	202
<u>Teteras de Hierro Fundido</u>	203
<u>Filtros de Café y Té</u>	209
<u>Molinillos de Café</u>	210
<u>Dispensadores de Cápsulas</u>	211
<u>Botellas de Aluminio</u>	212
<u>Botellas de Borosilicato</u>	212
<u>Botellas de Tritan</u>	213
<u>Botellas Termo Smart</u>	214
<u>Botellas Termo Classic</u>	216
<u>Botellas Termo Luxe</u>	220
<u>Vasos Termo</u>	220
<u>Latas Termo</u>	222
<u>Termos</u>	223
<u>Botellas de Cristal</u>	226
<u>Vasos y Tazas</u>	228
<u>Accesorios</u>	229

Cafeteras Express.

Cafeteras Express.

Essential.

ACERO INOXIDABLE 18/10
STAINLESS STEEL 18/10
ACIER INOXYDABLE 18/10
ROSTFREIER STAHL 18/10
AÇO INOXIDÁVEL 18/10



Cafetera Express

Espresso Coffee Maker
Cafetière Express
Espressokocher
Cafeteira Expresso



- Mango de Acero Inoxidable
- Stainless Steel Handle

ref.	☕	ml	📦	Bar Code
620302	2	100	1/6	8411922084320
620304	4	200	1/6	8411922084337
620306	6	300	1/6	8411922084344
620310	10	500	1/6	8411922084351

2 Juntas de Silicona + Filtro

2 Silicone Gaskets + Filter
2 Joints Silicone + Filtre
2 Dichtungen aus Silikon + Filter
2 Juntas de Silicone + Filtro



- Acero Inoxidable
- Stainless Steel

ref.	☕	📦	Bar Code
620350	2	6/204	8411922086669
620351	4	6/204	8411922086676
620352	6	6	8411922086683
620353	10	6/204	8411922086690

Cafeteras Express.

Indubasic.

ACERO INOXIDABLE 18/10
STAINLESS STEEL 18/10
ACIER INOXYDABLE 18/10
ROSTFREIER STAHL 18/10
AÇO INOXIDÁVEL 18/10



Cafetera Express

Espresso Coffee Maker
Cafetière Express
Espressokocher
Cafeteira Expresso



- Mango de Baquelita
- Bakelite Handle

ref.	☕	ml	📦	Bar Code
611302	2	100	1/6	8411922071566
611304	4	185	1/6	8411922071573
611306	6	280	1/6	8411922071580
611312	12	500	1/6	8411922071597

Junta de Silicona Cafetera

Coffee Maker Silicone Gasket
Joint Silicone Cafetière
Dichtung aus Silikon Espressokocher
Junta de Silicone Cafeteira



ref.	☕	📦	Bar Code
611358	2	1/200	8411922072471
611359	4	1	8411922072488
611360	6	1/200	8411922072495
611361	12	1	8411922072501

Cafetera Express

Espresso Coffee Maker
Cafetière Express
Espressokocher
Cafeteira Expresso



- Mango de Baquelita
- Bakelite Handle

ref.	☕	ml	📦	Bar Code
611002	2	100	1/6	8411922449730
611004	4	185	1/6	8411922449747
611006	6	280	1/6	8411922449754
611010	10	460	1/6	8411922449761
611015	15	700	1/6	8411922451535

NEW

Cafetera Express Blu

Blu Espresso Maker
Cafetière Express Blu
Espressokocher Blu
Cafeteira Express Blu



ref.	☕	ml	📦	Bar Code
629802	2	100	1/6	8411922475838
629804	4	185	1/6	8411922475845
629806	6	280	1/6	8411922475852
629810	10	460	1/6	8411922475869

NEW

Cafetera Express Rosso

Rosso Espresso Maker
Cafetière Express Rosso
Espressokocher Rosso
Cafeteira Express Rosso



ref.	☕	ml	📦	Bar Code
629702	2	100	1/6	8411922475791
629704	4	185	1/6	8411922475807
629706	6	280	1/6	8411922475814
629710	10	460	1/6	8411922475821

NEW

Cafetera Express Cupra

Cupra Espresso Maker
Cafetière Express Cupra
Espressokocher Cupra
Cafeteira Express Cupra



ref.	☕	ml	📦	Bar Code
629902	2	100	1/6	8411922475876
629904	4	185	1/6	8411922475883
629906	6	280	1/6	8411922475890
629910	10	460	1/6	8411922475906

NEW

Cafetera Express Mini 2 Tazas

Mini 2-cup Espresso Maker
Cafetière Express Mini 2 tasses
Espressokocher Mini 2 Tassen
Cafeteira Express Mini 2 xícaras



ref.	☕	ml	📦	Bar Code
630000	2	100	1/6	8411922475913



Cafeteras Express.

Elba.

ALUMINIO FUNDIDO. ACERO INOXIDABLE

CAST ALUMINUM. STAINLESS STEEL
FONTE D'ALUMINIUM. ACIER INOXYDABLE
ALUMINIUMGUSS. ROSTFREIER STAHL
ALUMÍNIO FUNDIDO. AÇO INOXIDÁVEL



induction



vitro



electric



gas



Cafetera Express Red

Red Espresso Coffee Maker
Cafetière Express Red
Espressokocher Red
Cafeteira Espresso Red

ref.	☕	ml	☕ (cm)	☕ (cm)	☐	Bar Code
▶ 627903	3	150	10	±2	1/6	8411922460360
627906	6	300	11	±2	1/6	8411922460377
627909	9	450	12	±2	1/6	8411922460384
627912	12	600	13	±2	1/6	8411922471205

▶ Con reductor para 2 tazas



Interior arenado
Sandblasting inside

Cafetera Express Black

Black Espresso Coffee Maker
Cafetière Express Black
Espressokocher Black
Cafeteira Expresso Black



ref.	☕	ml	☕ (cm)	☕ (cm)	📦	Bar Code
▶ 629203	3	150	10	±2	1/6	8411922474640
629206	6	300	11	±2	1/6	8411922474657
629209	9	450	12	±2	1/6	8411922474664
629212	12	600	13	±2	1/6	8411922474671

▶ Con reductor para 2 tazas

NEW

Cafetera Express Green

Green Espresso Maker
Cafetière Express Green
Espressokocher Green
Cafeteira Express Green



ref.	☕	ml	☕ (cm)	☕ (cm)	📦	Bar Code
▶ 630103	3	150	10	±2	1/6	8411922475920
630106	6	300	11	±2	1/6	8411922475937
630109	9	450	12	±2	1/6	8411922475944
630112	12	600	13	±2	1/6	8411922475951

▶ Con reductor para 2 tazas

Cafetera Express Peach

Peach Espresso Coffee Maker
Cafetière Express Peach
Espressokocher Peach
Cafeteira Expresso Peach

ref.	☕	ml	☕ (cm)	☕ (cm)	📦	Bar Code
▶ 629403	3	150	10	±2	1/6	8411922474725
629406	6	300	11	±2	1/6	8411922474732
629409	9	450	12	±2	1/6	8411922474749
629412	12	600	13	±2	1/6	8411922474756

▶ Con reductor para 2 tazas

Cafetera Express Blue

Blue Espresso Coffee Maker
Cafetière Express Blue
Espressokocher Blue
Cafeteira Expresso Blue



ref.	☕	ml	☕ (cm)	☕ (cm)	📦	Bar Code
▶ 629303	3	150	10	±2	1/6	8411922474688
629306	6	300	11	±2	1/6	8411922474695
629309	9	450	12	±2	1/6	8411922474701
629312	12	600	13	±2	1/6	8411922474718

▶ Con reductor para 2 tazas

NEW

Cafetera Express Coffee

Coffee Espresso Maker
Cafetière Express Coffee
Espressokocher Coffee
Cafeteira Express Coffee



ref.	☕	ml	☕ (cm)	☕ (cm)	📦	Bar Code
▶ 630203	3	150	10	±2	1/6	8411922475968
630206	6	300	11	±2	1/6	8411922475975
630209	9	450	12	±2	1/6	8411922475982
630212	12	600	13	±2	1/6	8411922475999

▶ Con reductor para 2 tazas



Cafeteras Express.

Evva.

ALUMINIO FUNDIDO

CAST ALUMINUM
FONTE D'ALUMINIUM
ALUMINIUMGUSS
ALUMÍNIO FUNDIDO

Recubrimiento interior
ANTIADHERENTE para una
mayor higiene

NON-STICK inner coating for
better cleaning

- Full Induction
- Máxima Eficiencia Energética
- Asas de Baquelita
- Full Induction
- Maximum Energy Efficiency
- Bakelite Handles



Cafetera Express Black

Black Espresso Coffee Maker
Cafetière Express Black
Espressokocher Black
Cafeteira Expresso Black



ref.	☕	ml	📦	Bar Code
623106	3/6	300	1/6	8411922436938
623109	9	450	1/6	8411922436945
623112	12	600	1/6	8411922436952

Cafetera Express Red

Red Espresso Coffee Maker
Cafetière Express Red
Espressokocher Red
Cafeteira Expresso Red

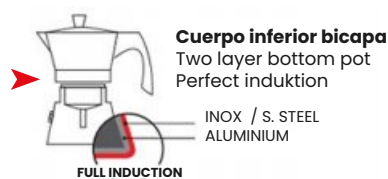

ref.	☕	ml	📦	Bar Code
623202	2	100	1/6/24	8411922440997
623203	3	150	1/6/24	8411922436969
623206	3/6	300	1/6	8411922436976
623209	9	450	1/6	8411922436983
623212	12	600	1/6	8411922436990

Cafetera Express Toscana

Espresso Coffee Maker Toscana
Cafetière Express Toscana
Espressokocher Toscana
Cafeteira Expresso Toscana



ref.	☕	ml	📦	Bar Code
622106	3/6	300	1/6	8411922457049
622109	9	400	1/6	8411922457056
622112	12	600	1/6	8411922457063

Cafetera Express Veneto

Espresso Coffee Maker Veneto
Caffettiera Espresso Veneto
Espressokocher Veneto
Cafeteira Expresso Veneto



ref.	☕	ml	📦	Bar Code
627806	6	300	1/6	8411922459784
627809	9	400	1/6	8411922459791
627812	12	600	1/6	8411922459807

Cafetera Express White

White Espresso Coffee Maker
Cafetière Express Red
Espressokocher White
Cafeteira Expresso White



- Full Induction
- Mango de Baquelita
- Full Induction
- Bakelite Handle

ref.	☕	ml	☕ (cm)	☕ (cm)	📦	Bar Code
628406	3/6	300	9,50	±2	1/6	8411922471083
628409	9	450	10	±2	1/6	8411922471090
628412	12	600	12	±2	1/6	8411922471106

Cafeteras
Express.

Bahía.

ALUMINIO FUNDIDO
CAST ALUMINUM
FONTE D'ALUMINIUM
ALUMINIUMGUSS
ALUMÍNIO FUNDIDO



Cafetera Express

Espresso Coffee Maker
Cafetière Express
Espressokocher
Cafeteira Expresso



ref.	☕	ml	📦	Bar Code
610901	1	50	6/24	8411922084719
610903	3	150	1/6/12	8411922431902
610906	6	300	1/6/12	8411922431919
610909	9	450	1/6/12	8411922431926
610912	12	500	1/6	8411922431933
610914	14	700	1/6	8411922440621

Cafetera Express Black

Black Espresso Coffee Maker
Cafetière Express Black
Espressokocher Black
Cafeteira Expresso Black



ref.	☕	ml	📦	Bar Code
612201	1	50	1/6/24	8411922084726
612203	3	150	1/6/12	8411922082913
612206	6	300	1/6/12	8411922082920
612209	9	600	1/6/12	8411922082937
612212	12	700	1/6	8411922082944

Cafetera Express Red

Red Espresso Coffee Maker
Cafetière Express Red
Espressokocher Red
Cafeteira Expresso Red



ref.	☕	ml	📦	Bar Code
612303	3	150	1/6/12	8411922444087
612306	6	300	1/6/12	8411922444094
612309	9	450	1/6/12	8411922445008
612312	12	600	1/6	8411922445015

Junta de Silicona Cafetera

Coffee Maker Silicone Gasket
Joint Silicone Cafetière
Dichtung aus Silikon
Kafeemaschine
Junta Silicone Cafeteira



ref.	☕	ml	📦	Bar Code
610958	3	150	1/6	8411922073072
610959	6	300	6/144	8411922073089
610960	9	450	6	8411922073096
610961	12	600	6/144	8411922073102

Adaptador Inducción para Cafeteras

Induction Adaptor for Coffee Makers
Adaptateur d'Induction pour Cafetières
Induktionsadapter für Espressokocher
Adaptador Indução para Cafeteiras



ref.	☕ (cm)	📦	Bar Code
705312	12	4/12	8411922452426

Cafeteras Émbolo.

Cafetera Émbolo Cristal + Plástico

Glass + Plastic French Press
Cafetière à Piston Verre + Plastique
French Press Glas + Kunststoff
Cafeteira Embolo Vidro + Plástico



- Borosilicato
- Plástico
- Borosilicate
- Plastic

ref.	Lts		Bar Code
623703	0,35	1/6/24	8411922439151
623706	0,60	1/6/24	8411922439168
623710	1	1/6/12	8411922439175

Cafetera Émbolo Cristal + Inox

Glass + Stainless Steel French Press
Cafetière à Piston Verre + Inox
French Press Glas + Edelstahl
Cafeteira Embolo Vidro + Inox



- Borosilicato
- Acero Inoxidable
- Borosilicate
- Stainless Steel

ref.	Lts		Bar Code
625406	0,60	1/6/24	8411922449846
625408	0,80	1/6/24	8411922449853
625410	1	1/6/12	8411922449860

Hervidores.

Hervidores.

Hervidores de Acero.

ACERO INOXIDABLE
STAINLESS STEEL
ACIER INOXYDABLE
ROSTFREIER STAHL
AÇO INOXIDÁVEL

Cafetera Pava con Filtro

Kettle with Filter
Bouilloire avec Filtre
Wasserkessel mit Filter
Chaleira com Filtro



- Asa Abatible
- Folding Handle



ref.	Lts		Bar Code
610109	0,80	1/12	8411922069037
610115	1,30	1/12	8411922208092
610120	1,80	1/12	8411922069051

Cafetera Pava

Stainless Steel Kettle
Bouilloire Inox
Edelstahl Wasserkessel
Chaleira Inox



ref.	Lts		Bar Code
610201	1,75	1/12	8411922421163
610202	2,75	1/6	8411922421262
610203	3,50	1/6	8411922421361
610204	4	1/6	8411922421552

Cafetera Silbante Marmore

Marmore Whistling Kettle
Bouilloire Siffiante Marmore
Marmore Flötenkessel
Chaleira com Apito Marmore



ref.	Lts	☐	Bar Code
610425M	2,50	1/6	8411922451801

Cafetera Silbante Blanca

White Whistling Kettle
Bouilloire Siffiante Blanche
Weiße Flötenkessel
Chaleira com Apito Blanca



ref.	Lts	☐	Bar Code
610425B	2,50	1/6	8411922448504

Cafetera Silbante Negra

Black Whistling Kettle
Bouilloire Siffiante Noire
Schwarze Flötenkessel
Chaleira com Apito Negra



ref.	Lts	☐	Bar Code
610425N	2,50	1/6	8411922448511

Cafetera Silbante Inox

Stainless Steel Whistling Kettle
Bouilloire Siffiante Inox
Edelstahl Flötenkessel
Chaleira com Apito Inox



- Asa Abatible
- Folding Handle



ref.	Lts	☐	Bar Code
610415	1,50	1/6	8411922207873
610425	2,50	1/6	8411922205671

Hervidores.

Hervidores de Borosilicato.

Tetera con Filtro Stove

Stove Teapot with Filter
Théière avec Filtre Stove
Teekanne mit Filter Stove
Chaleira com Filtro Stove



- Filtro Inox
- Perfecto filtrado
- Stainless Steel Filter
- Perfect filtered



ref.	Lts	☐	Bar Code
621704	0,45	1/6/24	8411922090895
621708	0,80	1/6/12	8411922434712

Tetera con Filtro Induction

Induction Teapot with Filter
Théière avec Filtre Induction
Teekanne mit Filter Induction
Chaleira com Filtro Induction



- Filtro Inox
- Perfecto filtrado
- Stainless Steel Filter
- Perfect filtered



ref.	Lts	☐	Bar Code
621908	0,80	1/6/24	8411922090901
621912	0,12	1/6/12	8411922090918

Jarra de Borosilicato

Borosilicate Jug
Pichet en Borosilicate
Krug Aus Borosilikatglas
Jarra de Borossilicato



ref.	Lts	📦	Bar Code
624903	0,35	6/36	8411922441420
624906	0,60	6/24	8411922441437
624910	1	6/24	8411922441444
624912	1,20	6/24	8411922441451

Hervidor con Filtro Square

Square Boiler with Filter
Bouilloire avec Filtre Square
Teekoher mit Sieb Square
Fervedor com Filtro Square



- Filtro Inox
- Stainless Steel Filter



ref.	ml	📦	Bar Code
625506	600	1/6/24	8411922449952
625510	1000	1/6/24	8411922449969

Teteras Árabes.

ACERO INOXIDABLE
STAINLESS STEEL
ACIER INOXYDABLE
ROSTFREIER STAHL
AÇO INOXIDÁVEL



Tetera Árabe Mahdia

Arabic Teapot Mahdia
Théière Arabe Mahdia
Arabische Teekanne Mahdia
Chaleira Árabe Mahdia



ref.	Lts	📦	Bar Code
611950	0,65	1/6	8411922454833
611951	1	1/6	8411922454840
611952	1,40	1/6	8411922454857

Tetera Árabe El Yadida

Arabic Teapot El Yadida
Théière Arabe El Yadida
Arabische Teekanne El Yadida
Chaleira Árabe El Yadida



ref.	Lts	📦	Bar Code
612050	0,65	1/6	8411922454864
612051	1	1/6	8411922454871
612052	1,40	1/6	8411922454888

Tetera Árabe Agadir

Arabic Teapot Agadir
Théière Arabe Agadir
Arabische Teekanne Agadir
Chaleira Árabe Agadir



ref.	Lts	📦	Bar Code
612103	0,30	1/6	8411922457117
612104	0,45	1/6	8411922457124



Café y Té.

Teteras Cerámicas.

GRÉS ESMALTADO

GLAZED STONEWARE

GRÈS ÉMAILLÉ

GLASIERTES STEINGUT

GRÉS ESMALTADO



250°C/-20°C



Tetera Gres Esmaltado Devon

Glazed Storeware Tea Pot

Théière Grès-Emaillé

Teekanne Glasiertes Steingut

Chaleira Grés Esmaltado

• Filtro Inox

• Stainless Steel Filter

ref.	ml	L (cm)	W (cm)	H (cm)	📦	Bar Code
688900	1350	23	14	16,50	1/6	8411922470727



Azucarero Gres Esmaltado Devon

Glazed Storeware Sugar Bowl

Sucrier Grès-Emaillé

Zuckerdose Glasiertes Steingut

Açucareiro Grés Esmaltado

ref.	ml	∅ (cm)	H (cm)	📦	Bar Code
688901	300	9	10,50	1/6/24	8411922470734



Lechera Gres Esmaltado Devon

Glazed Storeware Milk Churn

Bidon à Lait Grès-Emaillé

Milchkanne Glasiertes Steingut

Leiteira Grés Esmaltado

ref.	ml	L (cm)	W (cm)	H (cm)	📦	Bar Code
688902	300	12,50	8,50	9,50	1/6/24	8411922470741



Teteras de Hierro Fundido.

HIERRO FUNDIDO

CAST IRON

FER FORGÉ

GEGOSSENES EISEN

FERRO DE CAIXA



- Filtro Inox
- Interior Esmaltado
- Stainless Steel Filter
- Enamelled inside



Tetera Negra

Negra Teapot

Théière Negra

Teekanne Negra

Chaleira Negra



ref.	Lts	📦	Filter	Bar Code
620003	0,30	1/6	620804	8411922081763
620007	0,72	1/6	620806	8411922080865
NEW 620010	1	1/6		8411922475005
620012	1,20	1/6	620801	8411922080872
620018	1,80	1/6		8411922458534

Tetera Izum

Izum Teapot
Théière Izum
Teekanne Izum
Chaleira Izum



ref.	Lts		Bar Code
627511	1,10	1/6	8411922459425

Tetera Negara

Negara Teapot
Théière Negara
Teekanne Negara
Chaleira Negara



ref.	Lts		Filter	Bar Code
626608	0,80	1/6	620804	8411922454338

Tetera El Cairo

El Cairo Teapot
Théière El Cairo
Teekanne El Cairo
Chaleira El Cairo



ref.	Lts		Filter	Bar Code
626712	1,20	1/6	620801	8411922454345

Tetera Lombok

Lombok Teapot
Théière Lombok
Teekanne Lombok
Chaleira Lombok



ref.	Lts		Bar Code
626811	1,10	1/6	8411922454352

Tetera Ceylan

Ceylan Teapot
Théière Ceylan
Teekanne Ceylan
Chaleira Ceylan



ref.	Lts		Bar Code
620407	0,70	1/6	8411922084986

Tetera Java

Java Teapot
Théière Java
Teekanne Java
Chaleira Java



ref.	Lts		Filter	Bar Code
621510	1	1/6	620806	8411922088922

Tetera Bali

Bali Teapot
Théière Bali
Teekanne Bali
Chaleira Bali



ref.	Lts		Bar Code
621612	1,20	1/6	8411922088939

Tetera Malasia

Malasia Teapot
Théière Malasia
Teekanne Malasia
Chaleira Malasia



ref.	Lts		Bar Code
621408	0,80	1/6	8411922088915

Tetera Azul

Azul Teapot
Théière Azul
Teekanne Azul
Chaleira Azul



ref.	Lts		Filter	Bar Code
620212	1,20	1/6	620801	8411922080896

Tetera Verde

Verde Teapot
Théière Verde
Teekanne Verde
Chaleira Verde



ref.	Lts		Filter	Bar Code
620107	0,78	1/6	620806	8411922080889

Tetera Hanoi

Hanoi Teapot
Théière Hanoi
Teekanne Hanoi
Chaleira Hanoi



ref.	Lts		Filter	Bar Code
622603	0,30	1/6	620804	8411922435450

Tetera Laos

Laos Teapot
Théière Laos
Teekanne Laos
Chaleira Laos



ref.	Lts		Bar Code
620904	0,30	1/6	8411922086706

Tetera Nepal

Nepal Teapot
Théière Nepal
Teekanne Nepal
Chaleira Nepal



ref.	Lts		Bar Code
622805	0,50	1/6	8411922435474

Tetera Sana

Sana Teapot
Théière Sana
Teekanne Sana
Chaleira Sana



ref.	Lts		Bar Code
625706	0,60	1/6	8411922451498

Tetera Doha

Doha Teapot
Théière Doha
Teekanne Doha
Chaleira Doha



ref.	Lts		Bar Code
625603	0,30	1/6	8411922451481

Tetera Luang

Luang Teapot
Théière Luang
Teekanne Lung
Chaleira Luang



ref.	Lts		Bar Code
627407	0,70	1/6	8411922458756

Tetera Manaos

Manaos Teapot
Théière Manaos
Teekanne Manaos
Chaleira Manaos



ref.	Lts		Filter	Bar Code
624003	0,30	1/6	620804	8411922439373

Tetera Graffiti

Graffiti Teapot
Théière Graffiti
Teekanne Graffiti
Chaleira Graffiti



ref.	Lts		Filter	Bar Code
624303	0,35	1/6	620804	8411922439403

Tetera Kuta

Kuta Teapot
Théière Kuta
Teekanne Kuta
Chaleira Kuta



ref.	Lts		Bar Code
624103	0,30	1/6	8411922439380

Tetera Osaka

Osaka Teapot
Théière Osaka
Teekanne Osaka
Chaleira Osaka



ref.	Lts		Filter	Bar Code
624204	0,40	1/6	620804	8411922439397

Tetera India

India Teapot
Théière India
Teekanne India
Chaleira India



ref.	Lts		Filter	Bar Code
620508	0,80	1/6	620806	8411922084993

Tetera Kerala

Kerala Teapot
Théière Kerala
Teekanne Kerala
Chaleira Kerala



ref.	Lts		Bar Code
626912	1,20	1/6	8411922445533

Tetera Daca

Daca Teapot
Théière Daca
Teekanne Daca
Chaleira Daca



ref.	Lts		Bar Code
625808	0,85	1/6	8411922451504

Tetera Nara

Nara Teapot
Théière Nara
Teekanne Nara
Chaleira Nara



ref.	Lts		Filter	Bar Code
620712	1,20	1/6	620801	8411922440546

Tetera Yunan

Yunan Teapot
Théière Yunan
Teekanne Yunan
Chaleira Yunan



ref.	Lts		Bar Code
627308	0,80	1/6	8411922458527

NEW

Tetera Yame

Yame Teapot
Théière Yame
Teekanne Yame
Chaleira Yame



ref.	Lts	Filter		Bar Code
629612	1,20	620801	1/6	8411922475395

NEW

Tetera Lamam

Lamam Teapot
Théière Lamam
Teekanne Lamam
Chaleira Lamam



ref.	Lts		Bar Code
629511	1,10	1/6	8411922475098

Reposateteras Bali

Bali Teapot Trivet
Support pour Théières Bali
Untersetzer für Teekannen Bali
Descanso para Chaleiras Bali



ref.	∅ (cm)		Bar Code
621030	15	1/6/24	8411922440522

Reposateteras Saigon

Saigon Teapot Trivet
Support pour Théières Saigon
Untersetzer für Teekannen Saigon
Descanso para Chaleiras Saigon



ref.	∅ (cm)		Bar Code
621005	13,50	1/6/24	8411922454314

Reposateteras Perth

Perth Teapot Trivet
Support pour Théières Perth
Untersetzer für Teekannen Perth
Descanso para Chaleiras Perth

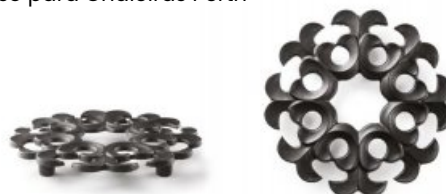

ref.	∅ (cm)		Bar Code
621015	13	1/6/24	8411922454321

Reposateteras Java

Java Teapot Trivet
Support pour Théières Java
Untersetzer für Teekannen Java
Descanso para Chaleiras Java



ref.	∅ (cm)		Bar Code
621040	15	1/6/24	8411922440539

Reposateteras Plano

Flat Teapot Trivet
Support Plat pour Théières
Flacher Untersetzer für Teekannen
Descanso para Chaleiras Plano



ref.	∅ (cm)		Bar Code
621000	13	1/6/24	8411922086713

Set 2 Tazas + 2 Platos Clásica

Set 2 Cups + 2 Saucers Clasica
 Jeu 2 Tasses + 2 Petites Assiettes Clasica
 Set 2 Tassen + 2 Untertassen Clasica
 Jogo 2 Canecas + 2 Pratos Clasica

- Hierro Fundido
- Interior Esmaltado
- Cast Iron
- Enamelled inside



ref.	Lts		Bar Code
624400	0,12	1/6	8411922439410

Calentador de Teteras

Teapot Warmer
 Chauffe-Théières
 Kannenstövchen
 Aquecedor para Chaleiras



ref.	∅ (cm)	H (cm)		Bar Code
625300	14	7	1/6	8411922448153

Filtro para Tetera

Filter for Teapot
 Filtre pour Théière
 Filter für Teekanne
 Filtro para Chaleira



- Acero Inoxidable 18/10
- Stainless Steel 18/10

Filter 620801:
 Teapot 620012+620212+626712+620712+629612

Filter 620804:
 Teapot 620003+620904+622104+625003
 622603+624003+624103+622608

Filter 620806:
 Teapot 620007+620508

ref.	∅ (cm)	H (cm)		Bar Code
620801	9	6	1/6/24	8411922085976
620804	7	4,50	1/6/24	8411922086003
620806	8	5,10	1/6/24	8411922086027





Jarra Infusora para Café / Té

Cold Brew Jug
Pitchet à Café / Té Froid
Cold Brew Kanne
Jarro de Infusão para Café /
Chá em Frio



- Borosilicato
- Plástico
- Filtro de Acero Inoxidable 18/10
- Borosilicate
- Plastic
- 18/10 Stainless Steel Filter

ref.	Lts	∅ (cm)	H (cm)	∩	Bar Code
690714	1,40	10	25	1/6/12	8411922474770

Colador de Franela

Flannel Strainer
Passoire Flanelle
Flanell-Sieb
Coador de Franela



- Franela
- Plástico
- Flannel
- Plastic

ref.	∅ (cm)	∩	Bar Code
797810	10	12/48	8411922433418
797812	12	12/48	8411922433425
797814	14	12/48	8411922433432

Filtro de Café y Cuchara Plástico

Coffee Filter and Spoon in Plastic
Filtre Café et Cuillère en Plastique
Kaffeefilter und Plastiklöffel
Filtro de Café e Colher de Plástico



- Plástico
- Plastic

ref.	∅ (cm)	Lts	∩	Bar Code
760900	12,50	1,50	10/120	8411922621815

Filtro para Té Inox

Stainless Steel Tea Filter
Filtre à Thé Inox
Edelstahl - Teefilter
Filtro de Chá Inox



- Acero Inoxidable 18/10
- Stainless Steel 18/10

ref.	∅ (cm)	H (cm)	∩	Bar Code
741508	6	7,30	1/6/48	8411922435252

Filtro Permanente Té y Café

Permanent Tea and Coffee Filter
Filtre Permanent Thé et Café
Permanent Tee- und Kaffeefilter
Filtro Permanente de Cha e Cafe



- Acero Inoxidable 18/10
- Stainless Steel 18/10

ref.	∅ (cm)	H (cm)	∩	Bar Code
611700	6	7,50	1/6	8411922072792

Infusor de Tubo

Tube Infuser
Infuseur à Tube
Röhrchen-Infusor
Infusor de Tubo



- Acero Inoxidable 18/10
- Stainless Steel 18/10

ref.	L (cm)	∩	Bar Code
731500	16	6/60	8411922086126

Infusor para Té Green

Green Tea Infuser
Infuseur de Thé Green
Grüner Tea - Infusor
Infusor de Chá Verde



- Acero Inoxidable
- Silicona
- Stainless Steel
- Silicone

ref.	∅ (cm)	∩	Bar Code
742000	16	6/36	8411922435313

Bola de Té

Tea Ball
Boule à Thé
Tee-Ei
Bola de Chá



- **Acero Inoxidable 18/10**
- Stainless Steel 18/10

ref.		Bar Code
702800	6/192	8411922207996

Pinza Bola de Té

Tea Ball Clamp
Pince Boule à Thé
Teesieb Klemme
Pinça Bola de Chá



- **Acero Inoxidable 18/10**
- Stainless Steel 18/10

ref.	∅ (cm)	H (cm)		Bar Code
703200	4	18	12/192	8411922209280
703206	6,50	18	6/144	8411922091779

Bola de Té Malla

Tea Infuser Ball Mesh
Boule-Infuseur Thé Maille
Mesh-Teekugel
Bola de Chá em Rede



- **Acero Inoxidable 18/10**
- Stainless Steel 18/10

ref.	∅ (cm)		Bar Code
761600	4	12/144	8411922621884

Cuchara de Té

Tea Spoon
Cuillère à Thé
Teelöffel
Colher para Chá



- **Acero Inoxidable 18/10**
- Stainless Steel 18/10

ref.	L (cm)		Bar Code
702900	15	6/216	8411922208009

Molinillos de Café.

Molinillo para Café Borosilicato

Borosilicate Coffee Grinder
Moulin à Café en Borosilicate
Handkaffeemühle Borosilikat
Moinho Manual Borosilicato



- **Regulable**
- **Muela cerámica**
- Adjustable
- Ceramic grinder

ref.	Lts	∅ (cm)	H (cm)		Bar Code
705810	0,35	8	18	1/6/18	8411922449587

Molinillo para Café

Coffee Grinder
Moulin à Café
Kaffeemühle
Moedor de Café



- **Madera**
- **Regulable**
- **Molido perfecto**
- Wood
- Adjustable
- Perfect ground

ref.	L (cm)	W (cm)		Bar Code	
750710	10	10	1/6/24	8411922439939	MARRÓN OSCURO/DARK BROWN
750720	10	10	1/6/24	8411922439946	MARRÓN CLARO/LIGHT BROWN

Dispensadores de Cápsulas.

Dispensadores de Cápsulas.

Dispensadores Nespresso.

ACERO CROMADO
CHROME STEEL
ACIER CHROMÉ
VERCHROMTER STAHL
AÇO CROMADO

Dispensador Nespresso Vesubio

Vesubio Nespresso Dispenser
Distributeur Nespresso Vesubio
Nespresso Spender Vesubio
Dispensador Nespresso Vesubio



36 UDS.

ref.	L (cm)	W (cm)	H (cm)	📦	Bar Code
780010	13	9	22	1/12	8411922082302

Dispensador Nespresso Fuji

Fuji Nespresso Dispenser
Distributeur Nespresso Fuji
Nespresso Spender Fuji
Dispensador Nespresso Fuji



44 UDS.

ref.	L (cm)	W (cm)	H (cm)	📦	Bar Code
780020	10	10	38	1/12	8411922082319

Dispensador Nespresso Tambora

Tambora Nespresso Dispenser
Distributeur Nespresso Tambora
Nespresso Spender Tambora
Dispensador Nespresso Tambora



40 UDS.

ref.	∅ (cm)	H (cm)	📦	Bar Code
780030	11	41	1/6	8411922082326

Dispensador Nespresso Volcano

Volcáno Nespresso Dispenser
Distributeur Nespresso Volcáno
Nespresso Spender Volcáno
Distribuidor de Nespresso Volcáno



40 UDS.

- Plástico
- Aluminio
- Giratorio
- Plastic
- Aluminium

ref.	L (cm)	W (cm)	H (cm)	📦	Bar Code
720920	13	13	36	1/4/8	8411922439328

Dispensadores de Cápsulas.

Dispensadores Dolce Gusto.

ACERO CROMADO
CHROME STEEL
ACIER CHROMÉ
VERCHROMTER STAHL
AÇO CROMADO

Dispensador Dolce Gusto Helens

Helens Dolce Gusto Dispenser
Distributeur Dolce Gusto Helens
Dolce Gusto Spender Helens
Dispensador Dolce Gusto Helens



36 UDS.

ref.	L (cm)	W (cm)	H (cm)	📦	Bar Code
780110	24	9,50	32	1/12	8411922082357

Dispensador Dolce Gusto Mauna

Mauna Dolce Gusto Dispenser
Distributeur Dolce Gusto Mauna
Dolce Gusto Spender Mauna
Dispensador Dolce Gusto Mauna



24 UDS.

ref.	∅ (cm)	H (cm)	📦	Bar Code
780100	14,50	33	1/6	8411922082340

Botellas de Aluminio.

ALUMINIO
ALUMINIUM
ALUMINIUM
ALUMINIUM
ALUMÍNIO

Botella Alpine

Alpine Bottle
Bouteille Alpine
Flasche Alpine
Garrafa Alpine



ref.	Lts	Ø (cm)	H (cm)	📦	Bar Code	
626103S	0,35	6,50	15,50	6	8411922452990	SATIN
626105B	0,50	7	19	6	8411922453010	BLACK
626107S	0,75	7	24,50	6	8411922453003	SATIN

Botellas de Borosilicato.

Botella Park

Park Bottle
Bouteille Park
Flasche Park
Garrafa Park



- Silicona
- Silicone

ref.	Lts	Ø (cm)	H (cm)	📦	Bar Code
757505P	0,50	7	22	3/6/24	8411922452785

Botella Kid

Kid Bottle
Bouteille Kid
Flasche Kid
Garrafa Kid



- Silicona
- Silicone

ref.	Lts	Ø (cm)	H (cm)	📦	Bar Code	
758910G	0,20	6	13,50	9/18	8411922452532	GRIS/GREY
758910P	0,20	6	13,50	9/18	8411922452549	ROSA/PINK

Botella Neopren Dark Blue

Dark Blue Neoprene Bottle
Bouteille Neoprene Dark Blue
Flasche Neoprene Dark Blue
Garrafa Neoprene Dark Blue



- Neopreno
- Neoprene

ref.	Lts	Ø (cm)	H (cm)	📦	Bar Code
758104B	0,42	6,50	20	3/6/24	8411922452808
758105B	0,55	6,50	24	3/6/24	8411922452815

Botella Cotton Grey

Cotton Grey Bottle
Bouteille Cotton Grey
Flasche Cotton Grey
Garrafa Cotton Grey



- Algodón
- Cotton

ref.	Lts	Ø (cm)	H (cm)	📦	Bar Code
758205G	0,55	6,50	24	3/6/24	8411922452822
758207G	0,75	7,50	23,50	3/6/24	8411922452839

Botella Dominó

Domino Bottle
Bouteille Domino
Flasche Domino
Garrafa Dominó



- Silicona
- Silicone



ref.	Lts	Ø (cm)	H (cm)	📦	Bar Code
751703	0,36	6,50	19	3/6/24	8411922452761
751705	0,55	6,80	24	3/6/24	8411922452778

Botella Sky

Sky Bottle
Bouteille Sky
Flasche Sky
Garrafa Sky



- Silicona
- Silicone

ref.	Lts		Bar Code	
745903A	0,36	3/6/36	8411922436747	AZUL/BLUE
745903V	0,36	3/6/36	8411922436754	VERDE/GREEN
745905A	0,50	3/6/36	8411922436761	AZUL/BLUE
745905V	0,50	3/6/36	8411922436778	VERDE/GREEN

Botella Lake

Lake Bottle
Bouteille Lake
Flasche Lake
Garrafa Lake



- Silicona
- Silicone

ref.	Lts		Bar Code	
746004R	0,40	3/6/24	8411922436785	ROJO/RED
746004V	0,40	3/6/24	8411922436792	VERDE/GREEN
746005V	0,55	3/6/36	8411922436815	VERDE/GREEN

Botellas de Tritan.

TRITÁN
TRITAN
TRITAN
TRITAN
TRITAN

Botella Sport

Sport Bottle
Bouteille Sport
Flasche Sport
Garrafa Sport



ref.	H (cm)	Lts		Bar Code
720307	25	0,72	3/6/24	8411922439571

Botella Sport Blue

Sport Blue Bottle
Bouteille Sport Blue
Flasche Sport Blue
Garrafa Sport Blue



ref.	H (cm)	Lts		Bar Code
720305	19,50	0,53	3/6/24	8411922439564

Botella Fresh

Fresh Bottle
Bouteille Fresh
Flasche Fresh
Garrafa Fresh



ref.	H (cm)	Lts		Bar Code
720106	23	0,58	3/6/24	8411922439557

Botella Aqua

Aqua Bottle
Bouteille Aqua
Flasche Aqua
Garrafa Aqua



ref.	H (cm)	Lts		Bar Code
720607	26	0,70	3/6/24	8411922440379
720610	30	1	3/6/24	8411922440386

Botella Finger

Finger Bottle
Bouteille Finger
Flasche Finger
Garrafa Finger



ref.	Lts		Bar Code
720006	0,60	6/24	8411922448948

Botella Infuser

Infuser Bottle
Bouteille Infuser
Flasche Infuser
Garrafa Infuser



ref.	H (cm)	Lts		Bar Code
720407	23,50	0,69	6/24	8411922439588

Botellas Termo Smart.

ACERO INOXIDABLE 18/10

STAINLESS STEEL 18/10
ACIER INOXYDABLE 18/10
ROSTFREIER STAHL 18/10
AÇO INOXIDÁVEL 18/10



10-12h

Vacio interior
Vaccum inside
Vide intérieur
Vakuumsolation
Vácuo interior



- **Hermético**
- Hermetic



Botella Termo Doble Pared Smart Hydrate & Reuse

Double Wall Thermo Bottle Smart Hydrate & Reuse
Bouteille Thermo Double Paroi Smart Hydrate & Reuse
Doppelwandige Thermoflasche Smart Hydrate & Reuse
Garrafa Termo de Parede Dupla Smart Hydrate & Reuse



ref.	Lts	Ø (cm)	H (cm)	📦	Bar Code
774959	0,50	6,80	24,50	12/24	8411922470420

Botella Termo Doble Pared Smart Design

Double Wall Thermo Bottle Smart Design

Bouteille Thermo Double Paroi Smart Design

Doppelwandige Thermoflasche Smart Design

Garrafa Termo de Parede Dupla Smart Design



MAREA
Maitane Urkiola



IMPACT
Teresa Pagaegi



SAMBA
Aritz Lekuona



SWIRL
Nerea Aguirre



HORIZON
Ainara Urria



COCOLINA
Mireia Elxepa



VINIKUNKA
Eider Gabirondo



SURF
Ana Ugarte



STIJL
Asier Jiménez



SIA
Nerea Murillo



GAILUR
Iratí Etxabe



ABAR
Naroa Laka



LORATZEN URDIN
Hodeia Bereziartua



NORABIDEA
Xuban Garai



CANVAS
Karmele Olariaga



LORATZEN HORI
Hodeia Bereziartua



SURF LEASH
Ibili Design



SURF SUNSET
Ibili Design



SURF KEEL
Ibili Design

ref.	Lts	Ø (cm)	H (cm)	☐	Bar Code	
774957	0,50	6,80	24,50	2/6/24	8411922458503	MAREA
774956	0,50	6,80	24,50	2/6/24	8411922458497	IMPACT
762940	0,50	6,80	24,50	2/6/24	8411922456318	SAMBA
762910	0,50	6,80	24,50	2/6/24	8411922456288	SWIRL
774955	0,50	6,80	24,50	2/6/24	8411922458480	HORIZON
774954	0,50	6,80	24,50	2/6/24	8411922458473	COCOLINA
774958	0,50	6,80	24,50	2/6/24	8411922458510	VINIKUNKA
762920	0,50	6,80	24,50	2/6/24	8411922456295	SURF
762950	0,50	6,80	24,50	2/6/24	8411922456455	STIJL
762930	0,50	6,80	24,50	2/6/24	8411922456301	SIA
774963	0,50	6,80	25,20	2/6/24	8411922474787	GAILUR
774964	0,50	6,80	25,20	2/6/24	8411922474794	ABAR
774965	0,50	6,80	25,20	2/6/24	8411922474800	LORATZEN URDIN
774967	0,50	6,80	25,20	2/6/24	8411922474824	NORABIDEA
774968	0,50	6,80	25,20	2/6/24	8411922474831	CANVAS
774966	0,50	6,80	25,20	2/6/24	8411922474817	LORATZEN HORI
774960	0,50	6,80	25,20	2/6/24	8411922470581	SURF LEASH
774961	0,50	6,80	25,20	2/6/24	8411922470598	SURF SUNSET
774962	0,50	6,80	25,20	2/6/24	8411922470604	SURF KEEL

Botella Termo Doble Pared Smart Solid

Double Wall Thermo Bottle Smart Solid
Bouteille Thermo Double Paroi Smart Solid
Doppelwandige Thermoflasche Smart Solid
Garrafa Termo de Parede Dupla Smart Solid

ref.	Lts	∅ (cm)	H (cm)	∅	Bar Code	
774950	0,50	6,80	24,50	2/6/24	8411922454697	PURE
774951	0,50	6,80	24,50	2/6/24	8411922454703	SEA
774952	0,50	6,80	24,50	2/6/24	8411922454710	OLIVE
774953	0,50	6,80	24,50	2/6/24	8411922454727	HOJA



PURE



SEA



OLIVE



HOJA

Botellas Termo Classic.

ACERO INOXIDABLE 18/10
STAINLESS STEEL 18/10
ACIER INOXYDABLE 18/10
ROSTFREIER STAHL 18/10
AÇO INOXIDÁVEL 18/10



Vacio interior
Vacuum inside
Vide intérieur
Vakuumisolation
Vácuo interior



Botella Termo Doble Pared Colorful 350ml

Double Wall Thermo Bottle Colorful 350ml
Bouteille Thermo Double Paroi Colorful 350ml
Doppelwandige Thermoflasche Colorful 350ml
Garrafa Termo de Parede Dupla Colorful 350ml

ref.	Lts	∅ (cm)	H (cm)	∅	Bar Code
758403	0,35	7	22	12/24	8411922454499



Botella Termo Doble Pared Colorful 500ml

Double Wall Thermo Bottle Colorful 500ml
Bouteille Thermo Double Paroi Colorful 500ml
Doppelwandige Thermoflasche Colorful 500ml
Garrafa Termo de Parede Dupla Colorful 500 ml

ref.	Lts	∅ (cm)	H (cm)	∅	Bar Code
758405	0,50	7	26	12/24	8411922452556



Botella Termo Doble Pared Colorful 775ml

Double Wall Thermo Bottle Colorful 775ml
Bouteille Thermo Double Paroi Colorful 775ml
Doppelwandige Thermoflasche Colorful 775ml
Garrafa Termo de Parede Dupla Colorful 775ml

ref.	Lts	∅ (cm)	H (cm)	∅	Bar Code
758475C	0,75	8	30,50	9/18	8411922457391



Botella Termo Doble Pared Classic Satin

Double Wall Thermo Bottle Classic Satin
Bouteille Thermo Double Paroi Classic Satin
Doppelwandige Thermoflasche Classic Satin
Garrafa Termo de Parede Dupla Classic Satin



ref.	Lts	∅ (cm)	H (cm)	📦	Bar Code
758410	1	9	34	2/6/12	8411922452419
758435	0,35	7	21,50	2/6/24	8411922443028
758450	0,50	7	26	2/6/24	8411922443035
758475	0,75	8	30,50	2/6/24	8411922443042

Botella Termo Doble Pared Zoo 350ml

Double Wall Thermo Bottle Zoo 350ml
Bouteille Thermo Double Paroi Zoo 350ml
Doppelwandige Thermoflasche Zoo 350ml
Garrafa Termo de Parede Dupla Zoo 350ml



ref.	Lts	∅ (cm)	H (cm)	📦	Bar Code
758435I	0,35	7	22	12/24	8411922457681

Botella Termo Doble Pared Classic Solid 350ml

Double Wall Thermo Bottle Classic Solid 350ml
Bouteille Thermo Double Paroi Classic Solid 350ml
Doppelwandige Thermoflasche Classic Solid 350ml
Garrafa Termo de Parede Dupla Classic Solid 350ml



GRANADA MUSGO MANGO BLACK DARK BLUE

ref.	Lts	∅ (cm)	H (cm)	📦	Bar Code	
758435R	0,35	7	22	2/6/24	8411922451153	GRANADA
758435V	0,35	7	22	2/6/24	8411922451139	MUSGO
758435P	0,35	7	22	2/6/24	8411922452471	MANGO
758435B	0,35	7	22	2/6/24	8411922443059	DARK BLUE
758435F	0,35	7	22	2/6/24	8411922454284	BLACK

Botella Termo Doble Pared Classic Solid 500ml

Double Wall Thermo Bottle Classic Solid 500ml
Bouteille Thermo Double Paroi Classic Solid 500ml
Doppelwandige Thermoflasche Classic Solid 500ml
Garrafa Termo de Parede Dupla Classic Solid 500ml



GRANADA MUSGO DARK BLUE MANGO

ref.	Lts	∅ (cm)	H (cm)	📦	Bar Code	
758450R	0,50	7	26	2/6/24	8411922451160	GRANADA
758450V	0,50	7	26	2/6/24	8411922451146	MUSGO
758450B	0,50	7	26	2/6/24	8411922443066	DARK BLUE
758450P	0,50	7	26	2/6/24	8411922452488	MANGO

Botella Termo Doble Pared Classic Design 350ml

Double Wall Thermo Bottle Classic Design
 Bouteille Thermo Double Paroi Classic Design
 Doppelwandige Thermoflasche Classic Design
 Garrafa Termo de Parede Dupla Classic Design

ref.	Lts	∅ (cm)	H (cm)	∅	Bar Code
758435U	0,35	7	22	2/6/24	8411922452624
758435Z	0,35	7	22	2/6/24	8411922452587
758435E	0,35	7	22	2/6/24	8411922452631
758435K	0,35	7	22	2/6/24	8411922452570
758435N	0,35	7	22	2/6/24	8411922452617
758435A	0,35	7	22	2/6/24	8411922454260
758435O	0,35	7	22	2/6/24	8411922452563
758435C	0,35	7	22	2/6/24	8411922454277
758435D	0,35	7	22	2/6/24	8411922451177
758435G	0,35	7	22	2/6/24	8411922454291
758435H	0,35	7	22	2/6/24	8411922454307



MOSAIC LEMON



ZIGZAG



EVORA



DOOBLE



SPRING LEMON



TROPIC



ARLEQUIN



OLATU



ELBA



LAGOS



AVEIRO



Botella Termo Doble Pared Classic Design 500ml

Double Wall Thermo Bottle Classic Design
Bouteille Thermo Double Paroi Classic Design
Doppelwandige Thermoflasche Classic Design
Garrafa Termo de Parede Dupla Classic Design



ARLEQUIN



SPRING
BLUE



JAIA



MARBLE



SYMBOL
BLUE



PORTO



LISBOA



OLATU



ARROW



DROP



MOSAIC
BLUE



FARO



GOLDEN
MARBLE



BLACK
MARBLE



FLORENCE



JARDIN



LILLE



VENICE



BAROQUE
BLUE



BAROQUE
BLACK



PALMA



BRIDGE



LIENZO

ref.	Lts	Ø (cm)	H (cm)	📦	Bar Code	
758450D	0,50	7	26	2/6/24	8411922451184	ARLEQUIN
758450J	0,50	7	26	2/6/24	8411922452716	SPRING BLUE
758450I	0,50	7	26	2/6/24	8411922454161	JAIA
758450H	0,50	7	26	2/6/24	8411922452709	MARBLE
758450S	0,50	7	26	2/6/24	8411922452686	SYMBOL BLUE
758450T	0,50	7	26	2/6/24	8411922452662	PORTO
758450W	0,50	7	26	2/6/24	8411922452648	LISBOA
758450O	0,50	7	26	2/6/24	8411922452679	OLATU
758450A	0,50	7	26	2/6/24	8411922452655	ARROW
758450G	0,50	7	26	2/6/24	8411922452723	DROP
758450M	0,50	7	26	2/6/24	8411922452693	MOSAIC BLUE
758450C	0,50	7	26	2/6/24	8411922454130	GOLDEN MARBLE
758450E	0,50	7	26	2/6/24	8411922454147	BLACK MARBLE
758450F	0,50	7	26	2/6/24	8411922454154	FLORENCE
758450K	0,50	7	26	2/6/24	8411922454178	JARDIN
758450L	0,50	7	26	2/6/24	8411922454185	LILLE
758450U	0,50	7	26	2/6/24	8411922454215	VENICE
758450Y	0,50	7	26	2/6/24	8411922454239	BAROQUE BLUE
758450N	0,50	7	26	2/6/24	8411922454192	PALMA
758450Z	0,50	7	26	2/6/24	8411922454246	BRIDGE
758450Q	0,50	7	26	2/6/24	8411922454208	LIENZO

Botellas Termo Luxe.

ACERO INOXIDABLE 18/10
STAINLESS STEEL 18/10
ACIER INOXYDABLE 18/10
ROSTFREIER STAHL 18/10
AÇO INOXIDÁVEL 18/10



Vacio interior
Vacuum inside
Vide intérieur
Vakuumisolation
Vácuo interior

Botella Termo Doble Pared Luxe Satin

Luxe Satin Double-Wall Bottle
Bouteille Thermo Double Paroi Luxe Satin
Doppelwandige Thermosflasche Luxe Satin
Garrafa Termos de Parede Dupla Luxe Satin



ref.	Lts	∅ (cm)	H (cm)	∩	Bar Code
626305S	0,50	7,50	23	3/6	8411922453058

Botella Termo Doble Pared Lemon

Lemon Double-Wall Thermo Bottle
Bouteille Thermo Double Paroi Lemon
Doppelwandige Thermosflasche Lemon
Garrafa Termos de Parede Dupla Lemon



ref.	Lts	∅ (cm)	H (cm)	∩	Bar Code
626206L	0,63	7,50	26	3/6	8411922453034

Expositor para Botellas

Bottle Display
Bouteille Expositant
Ständer für Flaschen
Expositor de Garrafas



ref.	L (cm)	W (cm)	H (cm)	∩	Bar Code
000907	65	65	190	1	8411922452860

Vasos Termo.

ACERO INOXIDABLE 18/10
STAINLESS STEEL 18/10
ACIER INOXYDABLE 18/10
ROSTFREIER STAHL 18/10
AÇO INOXIDÁVEL 18/10



Vacio interior
Vacuum inside
Vide intérieur
Vakuumisolation
Vácuo interior

NEW

Vaso Doble Pared Sport

Sport Double-Walled Thermal Mug
Verre Thermo Double Paroi Sport
Thermobecher mit Doppelwand Sport
Caneca Térmica Parede Dupla Esporte



ref.	∅ (cm)	H (cm)	ml	∩	Bar Code
667626Z	8	13	260	3/6/24	8411922475449
667626C	8	13	260	3/6/24	8411922475456

ZAFIRO
CAFÉ

NEW

Vaso Doble Pared Luxe

Luxe Double-Walled Thermal Mug
Verre Thermo Double Paroi Luxe
Thermobecher mit Doppelwand Luxe
Copo Parede Dupla Luxe



ref.	∅ (cm)	H (cm)	ml	∩	Bar Code
667536T	8,50	15	360	3/6/24	8411922475425
667536C	8,50	15	360	3/6/24	8411922475432

TITANIO
CAFÉ

Vaso Térmico Doble Pared Satin

Double-Wall Thermal Mug Satin
Verre Thermo Double Paroi Satin
Thermobecher mit Doppelwand Satin
Caneca Térmica de Parede Dupla Satin



ref.	Lts	Ø (cm)	H (cm)	📦	Bar Code
758328	0,28	9	13	1/6/24	8411922442083
758341	0,41	9	17	1/6/24	8411922442090

Vaso Térmico Doble Pared Blueberry

Double-Wall Thermal Mug Blueberry
Verre Thermo Double Paroi Blueberry
Thermobecher mit Doppelwand Blueberry
Caneca Térmica de Parede Dupla Blueberry



ref.	Lts	Ø (cm)	H (cm)	📦	Bar Code
758328B	0,28	9	13	1/6/24	8411922443004
758341B	0,41	9	17	1/6/24	8411922443011

Vaso Térmico

Thermal Mug
Verre Thermique
Thermobecher
Copo Térmico



- **Hermético**
- **Tapa separable, fácil de limpiar**
- **Revestido de silicona, tacto suave**
- Hermetic
- Detachable lid, easy to clean
- Stainless steel with silicone wrap, soft touch finish

ref.	Ø (cm)	H (cm)	Lts	📦	Bar Code
799904	7	20	0,40	6/24	8411922434583
799904A	7	20	0,40	6/24	8411922441918
799904R	7	20	0,40	6/24	8411922441925

Vaso Térmico Doble Pared Plástico

Plastic Double-wall Thermal Mug
Verre Thermo Double Paroi Plastic
Doppelwandige Thermokanne Plastik
Copo Térmico Parede Dupla Plástico



- **Plástico**
- Plastic



2-4h

ref.	H (cm)	Ø (cm)	Lts	📦	Bar Code
736200	17,50	8	0,38	9/18	8411922090130

Lata Thermo Blueberry

Blueberry Thermo Can
Thermo Canette Blueberry
Thermo-Dose Blueberry
Lata Thermo Blueberry



ref.	Lts	📦	Bar Code
796933A	0,33	6/24	8411922451238
796950A	0,50	6/24	8411922451245

Lata Thermo Granada

Granada Thermo Can
Thermo Canette Granada
Thermo-Dose Granada
Lata Thermo Granada



ref.	Lts	📦	Bar Code
796933R	0,33	6/24	8411922451252
796950R	0,50	6/24	8411922451269

Lata Thermo Mango

Mango Thermo Can
Thermo Canette Mango
Thermo-Dose Mango
Lata Thermo Mango



ref.	Lts	📦	Bar Code
796933P	0,33	6/24	8411922451276
796950P	0,50	6/24	8411922451283

Lata Thermo Musgo

Musgo Thermo Can
Thermo Canette Musgo
Thermo-Dose Musgo
Lata Thermo Musgo



ref.	Lts	📦	Bar Code
796933V	0,33	6/24	8411922451290
796950V	0,50	6/24	8411922451306

Lata Thermo Arlequín

Arlequin Thermo Can
Thermo Canette Arlequin
Thermo-Dose Arlequin
Lata Thermo Harlequin



ref.	Lts	📦	Bar Code
796933D	0,33	6/24	8411922451313
796950D	0,50	6/24	8411922451320

Lata Thermo Eco

Eco Thermo Can
Thermo Canette Eco
Thermo-Dose Eco
Lata Thermo Eco



ref.	Lts	📦	Bar Code
796900	0,33	6/12/24	8411922094084
796905	0,50	9/18	8411922435047

Lata Thermo Ball

Ball Thermo Can
Thermo Canette Ball
Thermo-Dose Ball
Lata Thermo Ball



ref.	Lts	📦	Bar Code
796950	0,33	6/24	8411922094091



Vacío interior
 Vacuum inside
 Vide intérieur
 Vakuumisolation
 Vacuo interior



Termo para Líquidos Royal

Royal Thermo for Liquids
 Thermo pour Liquides Inox Royal
 Thermokanne für Flüssigkeiten Royal
 Termo para Líquidos Royal



- **Hermético**
- **Con asa**
- Hermetic
- With hanger



+20h +12h

ref.	Lts	∅ (cm)	H (cm)	∅	Bar Code
758606	0,60	7,80	22,20	1/6	8411922451351
758609	0,90	9	23,60	1/6	8411922451368

Termo Trip Mini

Trip Mini Thermo
 Thermo Trip Mini
 Thermoflasche Trip Mini
 Termo Trip Mini



- **Hermético**
- **Tapa con sistema de bloqueo**
- Hermetic
- Lid with locking system



6-8h

ref.	ml	H (cm)	∅	Bar Code
765618	180	15,50	9/18	8411922470628

Vaso Doble Pared Portayogurt-Cereales

Double-wall Yoghurt and Cereal Cup
 Recipient Double Paroi pour Yaourt et Cereales
 Doppelnwandiger Becher für Joghurt und
 Copo de Parede Dupla para Iogurte e Cereais



- **Plástico**
- **Silicona**
- Plastic
- Silicone



8h

ref.	ml	∅ (cm)	H (cm)	∅	Bar Code
687300	500	9	18	1/6/24	8411922459753

Termo para Líquidos Office

Thermo for Liquids Office
 Thermo pour Liquides Office
 Thermokanne für Flüssigkeiten Office
 Termo para líquidos Office



12h

ref.	Lts	H (cm)	∅	Bar Code
775035	0,35	12	9/18	8411922455663

Termo para Líquidos Colorful Mini

Colourful Mini Thermo for Liquids
 Thermo pour Liquides Colorful Mini
 Mini Thermo für Flüssigkeiten Colorful
 Termo para Líquidos Colorful Mini



- **Hermético**
- Hermetic



24h

ref.	Lts	H (cm)	∅	Bar Code
753802C	0,15	17	12/24	8411922436266

Termo para Líquidos Colorful

Colourful Thermo for Liquids
Thermo pour Liquides Colorful
Thermo für Flüssigkeiten Colorful
Termo para Líquidos Colorful



24h

ref.	Lts	H (cm)	☐	Bar Code
753805C	0,50	25	12/24	8411922436273

Termo para Líquidos Mini

Mini Thermo for Liquids
Thermo pour Liquides Mini
Mini Thermo für Flüssigkeiten
Termo para Líquidos Mini



24h

ref.	Lts	∅ (cm)	H (cm)	☐	Bar Code	
753801	0,125	5	14	12/24	8411922088779	1 COFFEE
753802	0,15	5,50	17	12/24	8411922092622	2 COFFEES
753821	0,20	5,50	20,50	9/18	8411922436143	3 COFFEES

Termo para Líquidos

Thermo for Liquids
Thermo pour Liquides
Thermo für Flüssigkeiten
Termo para Líquidos



24h

ref.	Lts	☐	Bar Code
753803	0,30	1/6/12	8411922085907
753805	0,50	1/6/12	8411922085914
753807	0,70	1/6/12	8411922085921
753810	1	1/6/12	8411922085938
753812	1,20	1/6/12	8411922447989

Termo para Sólidos

Class Thermo for Solids
Thermo pour Aliments Solides Class
Thermo für Feststoffe Class
Termo para Sólidos Class



24h

ref.	Lts	☐	Bar Code
753906	0,55	1/6/12	8411922085945
753908	0,80	1/6/12	8411922085952
753910	1	1/6/12	8411922085969

Termo para Sólidos Class

Class Thermo for Solids
Thermo pour Aliments Solides Class
Thermo für Feststoffe Class
Termo para Sólidos Class



12h

ref.	∅ (cm)	Lts	H (cm)	☐	Bar Code
741407	12,30	0,75	14	1/6/12	8411922435214
741410	12,30	1	16	1/6/12	8411922435221
741412	12,30	1,20	18,50	1/6	8411922439816

- Silicona
- Silicone

Termo para Líquidos Abombado

Domed Thermo for Liquids
Thermo Bombé pour Liquides
Gewölbte Thermokanne für Flüssigkeiten
Termo para Líquidos Abaulado

- Soft Touch
- Hermético
- Soft Touch
- Hermetic



ref.	Lts	☐	Bar Code
745803	0,35	1/6/12	8411922436693
745805	0,50	1/6/12	8411922436709
745807	0,75	1/6/12	8411922436716
745810	1	1/6/12	8411922436723

Termo para Sólidos Mini

Mini Thermo for Solids
Thermo pour Aliments Solides Mini
Mini Thermo für Feststoffe
Termo para Sólidos Mini



ref.	Lts	☐	Bar Code
753903	0,40	9	8411922090611
753904	0,500	6/24	8411922093834

Termo para Sólidos Royal

Royal Thermo for Solids
Thermo pour Aliments Solides Royal
Thermo für Feststoffe Royal
Termo para Sólidos Royal



ref.	Lts	∅ (cm)	H (cm)	☐	Bar Code
758704	0,43	10	16	1/6	8411922452433
758706	0,62	10	19	1/6	8411922452440

Jarra Termo

Thermal Jug
Pichet Thermo
Thermokrug
Jarro Termo



ref.	Lts	☐	Bar Code
748110	1	1/6	8411922437645
748115	1,50	1/6	8411922437652

Termo Air Pot Interior Cristal

Glass-Lined Air Pot Thermo
Thermo Air Pot Intérieur Verre
Thermoflasche Air Pot Innen Glas
Termo Air Pot Interior de Vidro



- Vidrio
- Hermético
- Asa Abatible
- Su interior de cristal permite introducir lacteos
- Glass
- Hermetic
- Folding Handle
- Its glass interior is suitable for dairy products



ref.	Lts	∅ (cm)	H (cm)	☐	Bar Code
690319	1,90	13,50	37	1/6	8411922474268

Termo para Líquidos Familiar

Family Size Thermo for Liquids
Thermo pour Liquides Familial
Familiengröße Thermokanne für Flüssigkeiten
Termo para Líquidos Tamanho Familiar



ref.	Lts	∅ (cm)	H (cm)	∩	Bar Code
758814	1,40	10	32,50	1/6	8411922452457
758818	1,80	11	35	1/6	8411922452464

Termo Air Pot

Thermo Air Pot
Thermo Air Pot
Thermo Air Pot
Termo Air Pot



Termo Air Pot Class XL

Class Air Pot Thermo
Thermo Air Pot Class
Thermoflasche Air Pot Class
Termo Air Pot Class



- Asa Abatible
- Folding Handle



ref.	Lts	∅ (cm)	H (cm)	∩	Bar Code
703105	5	17,50	44,50	1/4	8411922474411

- Asa Abatible
- Folding Handle



ref.	Lts	H (cm)	∩	Bar Code
741202	2,20	35	1/6	8411922435160
741203	3	39	1/6	8411922441734

Botellas de Cristal.

VIDRIO
GLASS
VERRE
GLAS
VIDRO

Botella Line

Line Bottle
Bouteille Line
Flasche Line
Garrafa Line



ref.	Lts	∩	Bar Code
713610	1	6/18	8411922451955

Botella Lazo

Lazo Bottle
Bouteille Lazo
Flasche Lazo
Garrafa Lazo



- Acero Inoxidable
- Stainless Steel

ref.	Lts	∩	Bar Code
713405	0,50	6/24	8411922451962
713410	1	6/18	8411922451948

Botella 1L Decorada

Decorated Bottle 1L
Bouteille 1L Décorée
Dekorierte Flasche 1L
Garrafa 1L Decorada



• SURTIDO / ASSORTED 3A + 3B = 6

ref.	Lts		Bar Code
740111	1	6/12	8411922435627

Botella 1L

Bottle 1L
Bouteille 1L
Flasche 1L
Garrafa 1L

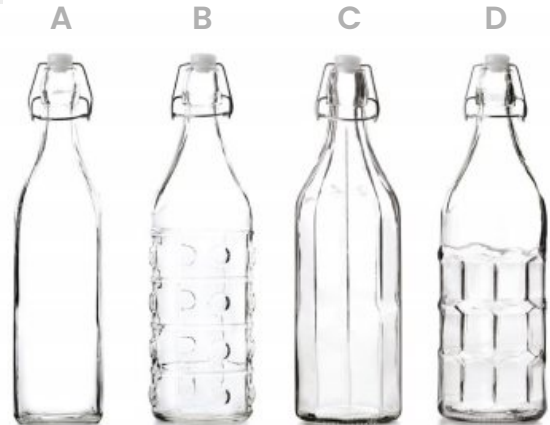

• SURTIDO / ASSORTED 2A + 2B + 1C + 1D = 6

ref.	Lts	H (cm)		Bar Code
740101	1	32	6/12	8411922434682

Botella Square

Square Bottle
Bouteille Square
Flasche Square
Garrafa Square



ref.	Lts		Bar Code
713705	0,50	6/36	8411922451993
713710	1	6/18	8411922451986

Botella Vintage

Vintage Bottle
Bouteille Vintage
Vintage Flasche
Garrafa Vintage



• SURTIDO / ASSORTED 3A + 3B = 6

ref.	Lts		Bar Code
740202	0,25	6/24	8411922435610
740205	0,50	6/24	8411922434699

Botella de Leche

Milk Bottle
Bouteille de Lait
Milchflasche
Garrafa de Leite



ref.	Lts	H (cm)		Bar Code
740310	1	29	6	8411922434705

Botella Retro

Bottle Retro
Bouteille Retro
Flasche Retro
Garrafa Retro



ref.	Lts		Bar Code
713810	1	6/18	8411922459586



Taza de Té con Filtro Salvia

Salvia Tea Cup with Filter
Tasse à Thé avec Filtre Salvia
Teetasse mit Sieb Salvia
Chávena de Chá Com Filtro



- Borosilicato
- Borosilicate

ref.	Lts		Bar Code
624500	0,40	1/6/24	8411922440225

Taza Cristal Doble Pared

Double-wall Glass Cup
Tasse en Verre à Double Paroi
Doppelwandiger Glasbecher
Chávena de Vidro com Parede Dupla



- Borosilicato
- Borosilicate

ref.	Ø (cm)	ml	H (cm)		Bar Code
685015	7	150	8	1/6/36	8411922458039
685022	8	220	9	1/6/24	8411922458046

Juego 6 Vasos de Té

Set 6 Tea Glasses
Jeu de 6 Verres à Thé
Teeservice mit 6 Gläsern
Jogo de 6 Copos para Chá



- Vidrio
- Glass

ref.	Ø (cm)	ml	H (cm)		Bar Code
685100	5,50	130	10	2/6	8411922458077

Taza de Cristal Asa Color

Glass Cup Colour Handle
Tasse en Verre Anse Couleur
Glasbecher Griff Farbe
Taça de Vidro Asa Cor



- Borosilicato
- Borosilicate

ref.	Ø (cm)	H (cm)	Lts		Bar Code
623803	8	8,50	0,30	8/24	8411922439182

Set 3 Decoradores de Espuma

Set 3 Cocoa Stencils
Jeu 3 Décorateurs de Mousse
Set 3 Schaum Dekorieren Schablonen
Jogo 3 Decoradores de Espuma



- **Acero Inoxidable**
- Stainless Steel



ref.	∅ (cm)		Bar Code
778200	10	6/72	8411922080599

Descalcificador de Teteras

Kettle Descaler
Anti-Calcaire pour Théières
Teebereiter-Entkalker
Descalcificador de Bules



- **Acero Inoxidable**
- **Al hervir con el agua absorbe la cal de la tetera**
- Stainless Steel
- Limescale fur will collect on the wire as the water boils

ref.	L (cm)	W (cm)		Bar Code
782110	3,50	2,50	6/144	8411922448573

NEW

Set Matcha 3 piezas

Matcha Set 3 pieces
Set Matcha 3 pièces
Matcha Set 3 Stück
Conjunto Matcha 3 peças



- **Bambú**
- Bamboo

ref.		Bar Code
667200	2/6	8411922475371

Caja para Té 6 Compartimentos Azul

Tea Box 6 Compartments Blue
Boîte à Thé 6 Compartiments Bleu
Teedose mit 6 Fächern Blau
Caixa de Chá 6 Compartimentos Azul



- **Madera de Pino**
- Pine Wood

ref.	L (cm)	W (cm)	H (cm)		Bar Code
748500	21,50	18	7	6	8411922437829

Set para Mate 4 Piezas

4-Piece Mate Set
Set Mate 4 pièces
4-Teiliges Matetee-Set
Jogo de 4 Peças para Mate



- **Acero Inoxidable**
- **Incluye vaso, bombilla redonda, bombilla plana y cepillo**
- Stainless Steel
- Includes cup, round bombilla, plane bombilla and brush

ref.	ml	∅ (cm)	H (cm)		Bar Code
685800	250	7,50	10,80	1/6/24	8411922459012



Envasador de Cápsulas de Café y Té

Coffee & Tea Capsule Filler
Machine de Conditionnement de Capsules de Café et Thé
Kaffee- und Tee-Kapselpacker
Máquina de Encher Cápsulas de Café & Chá



- **Plástico**
- **Rellena tus cápsulas plásticas de café o té cuantas veces quieras**
- **Compatible con sistema Nespresso**
- **Elige ahorrar, reutilizar, reducir y reciclar**
- **Incluye 10 cápsulas reutilizables**
- Plastic
- Refill your plastic capsules with coffee or tea as many times as you want
- Compatible with Nespresso system
- Choose to save, reuse, reduce and recycle
- Includes 10 reusable capsules

ref.	L (cm)	W (cm)		Bar Code
797600	19	12	1/6	8411922439717

NEW

Cepillo para Botellas y Termos de Silicona

Bottle and Thermos Brush
Brosse à Bouteilles et Thermos
Flaschen- und Thermosbürste
Escovilhão para Garrafas e Termos



- **Silicona**
- Silicone

ref.	L (cm)		Bar Code
691500	31	6/72	8411922475753

Cepillo Limpiador para Termos Mini

Mini Thermo Cleaning Brush
Brosse à Laver Mini Thermos
Reinigungsbürste für Mini Thermos
Escova de Limpeza para Mini Termos



- **Plástico**
- **Metálico**
- Plastic
- Metallic

ref.	L (cm)		Bar Code
755726	26	12/96	8411922437812

Esponja Limpiadora de Termos-Jarras-Sifones

Jug-Thermo-Siphon Cleaner Sponge
Éponge Nettoyeur pour Thermos-Pichet-Siphon
Reinigungsschwamm für Thermoskannen-Krüge-Siphons
Esponja de Limpeza para Termos-Jarras-Sifões



- **Esponja**
- **PP**
- Sponge
- PP

ref.		Bar Code
764700	12/72	8411922205718

Cepillo Limpiador para Botellas

Bottle Cleaning Brush
Brosse à Laver Bouteilles
Reinigungsbürste für Flaschen
Escova de Limpeza para Garrafas



- **Plástico**
- **Metálico**
- Plastic
- Metallic

ref.	L (cm)		Bar Code
755748	53	12/72	8411922068917

Set 4 Pajitas Inox + Cepillo Limpiador

Set 4 Stainless Steel Straws + Cleaning Brush
 Jeu 4 Pailles Inox + Brosse de Nettoyage
 4Er-Set Edelstahl-Strohhalme + Reinigungsbu
 Conjunto de 4 Palhinhas Inox + Escova de Limpeza



ref.	L (cm)	Ø (cm)	📦	Bar Code
702110	25	0,80	6/24	8411922448894

Lechera para Servir

Milk Pitcher
 Pot Crémier
 Milchkännchen
 Leiteira



- **Acero Inoxidable 18/10**
- Stainless Steel 18/10



ref.	ml	Ø (cm)	H (cm)	📦	Bar Code
628203	350	7,50	9	1/6/48	8411922470840
628206	600	9	11	1/6/24	8411922470857

Batidor-Espumador para Leche Class

Class Milk Frother-Blender
 Batteur-Mousseur à Lait Class
 Milchschaumer Class
 Batedor-Espumador para Leite Class



- **Plástico**
- **Acero Inoxidable**
- Plastic
- Stainless Steel



ref.	L (cm)	📦	Bar Code
688300	16	6/72	8411922470376

Batidor para Leche

Milk Blender
 Batteur à Lait
 Milchschaumer
 Batedor para Leite



- **Acero Inoxidable**
- Stainless Steel



ref.	L (cm)	📦	Bar Code
778110	20,50	6/48	8411922448566

Tarro para Café / Azúcar + Cucharilla

Jar for Coffee/Sugar + Spoon
 Récipient pour Café/Sucre + Cuillère
 Behälter für Kaffee/Zucker + Löffel
 Recipiente para Café/Açúcar + Colher



- **Borosilicato**
- **Bambú**
- Borosilicate
- Bamboo

ref.	L (cm)	W (cm)	H (cm)	ml	📦	Bar Code
688608	10	10	10	800	2/6/24	8411922470642
688612	10	10	15,20	1200	2/6/24	8411922470659



Varios Cocina Mesa.



Kitchen-Table

Divers Cuisine-Table

Verschiedenes Küche/Tisch

Varios Cozinha-Mesa

<u>Vajillas Porcelana</u>	235	<u>Pinzas</u>	307
<u>Cocina Saludable</u>	241	<u>Ralladores</u>	311
<u>Comida Internacional</u>	243	<u>Tapas</u>	314
<u>Artículos para Pan</u>	250	<u>Tablas de Cortar</u>	318
<u>Cerámica</u>	252	<u>Termómetros</u>	320
<u>Aceiteras y Recicladores</u>		<u>Utensilios</u>	322
<u>de Aceite</u>	255	<u>Utensilios Varios</u>	341
<u>Dispensadores</u>	261	<u>Barware</u>	369
<u>Bandejas y Bols</u>	263	<u>Accesorios</u>	386
<u>Coladores y Escurridores</u>	267	<u>Esmaltado Vintage</u>	391
<u>Conservación</u>	270	<u>Esmaltado Vintage Surtido</u>	407
<u>Cubiertos</u>	282	<u>Bolsas Isotermicas</u>	410
<u>Cuchillos y Tijeras</u>	284	<u>Camping</u>	414
<u>Peladores y Cortadores</u>	292	<u>Vajilla Desechable Eco</u>	415
		<u>Expositores</u>	417

Vajillas Porcelana.

Castilla Blanco.

PORCELANA

PORCELAIN
PORCELAINE
PORZELAIN
PORCELANA



NEW

Set 18 Piezas Blanco

Set of 18 White Pieces
Ensemble de 18 Pièces Blanc
Set 18 Stücke Weiß
Conjunto de 18 Peças Branco

- 6x Plato llano 27,1cm
- 6x Plato hondo 23,2cm
- 6x Plato postre 20,3cm
- 6x Flat plate 27,1cm
- 6x Soup plate 23,2cm
- 6x Dessert plate 20,3cm



ref.	∅ (cm)	H (cm)	📦	Bar Code
692100	20,3+23,2+27,1	2,2+2,3+3,5	1	8411922476224

NEW

Plato Llano Blanco

White Flat Plate
Assiette Plate Blanc
Flacher Teller Weiß
Prato Ladeiro Branco



ref.	∅ (cm)	H (cm)	📦	Bar Code
692101	27,10	2,30	6/12	8411922476231

NEW

Plato Hondo Blanco

White Deep Plate
Assiette Creuse Blanc
Tiefer Teller Weiß
Prato Sopeiro Branco



ref.	∅ (cm)	H (cm)	📦	Bar Code
692102	23,20	3,50	6/12	8411922476248

NEW

Plato Postre Blanco

White Dessert Plate
Assiette à Dessert Blanc
Dessertteller Weiß
Prato de Sobremesa Branco



ref.	∅ (cm)	H (cm)	📦	Bar Code
692103	20,30	2,20	6/24	8411922476255

Vajillas Porcelana.

Bolonia Blanco.

PORCELANA

PORCELAIN
PORCELAINE
PORZELAIN
PORCELANA



NEW

Set 18 Piezas Blanco

Set of 18 White Pieces
Ensemble de 18 Pièces Blanc
Set 18 Stücke Weiß
Conjunto de 18 Peças Branco

- 6x Plato llano 27cm
- 6x Plato hondo 20,4cm
- 6x Plato postre 19,1cm
- 6x Flat plate 27cm
- 6x Soup plate 20,4cm
- 6x Dessert plate 19,1cm



ref.	Ø (cm)	H (cm)	📦	Bar Code
692200	19,1+20,4+27	2+4,6+2,9	1	8411922476262

NEW

Plato Llano Blanco

White Flat Plate
Assiette Plate Blanc
Flacher Teller Weiß
Prato Ladeiro Branco



ref.	Ø (cm)	H (cm)	📦	Bar Code
692201	27	2,90	6/12	8411922476279

NEW

Plato Hondo Blanco

White Deep Plate
Assiette Creuse Blanc
Tiefer Teller Weiß
Prato Sopeiro Branco



ref.	Ø (cm)	H (cm)	📦	Bar Code
692202	20,40	4,60	6/12	8411922476286

NEW

Plato Postre Blanco

White Dessert Plate
Assiette Creuse Blanc
Tiefer Teller Weiß
Prato de Sobremesa Branco



ref.	Ø (cm)	H (cm)	📦	Bar Code
692203	19,10	2	6/24	8411922476293

Vajillas Porcelana.

Armonía Blue.

PORCELANA

PORCELAIN
PORCELAINE
PORZELAIN
PORCELANA



NEW

Set 12 Piezas Azul

Set 12 Blue Pieces
Ensemble de 12 Bleu Pièces
Set 12 Stücke Blau
Conjunto de 12 Peças Azul

- 4x Plato llano 26,8cm
- 4x Plato hondo 20cm
- 4x Plato postre 19cm
- 4x Flat plate 26,8cm
- 4x Soup plate 20cm
- 4x Dessert plate 19cm

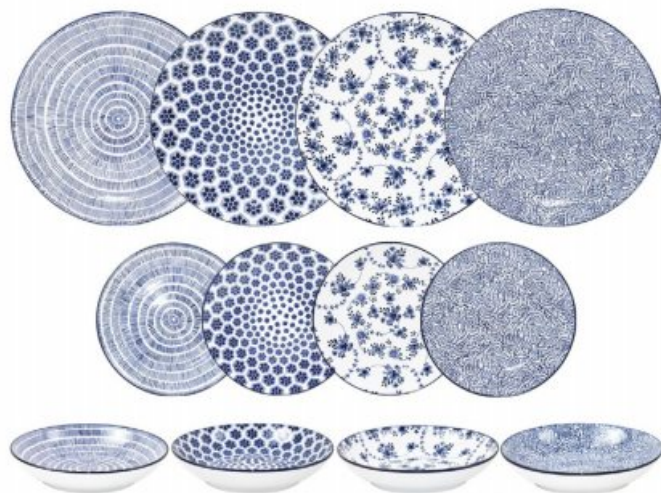

ref.	Ø (cm)	📦	Bar Code
691700	19+20+26,80	2	8411922476118

Vajillas Porcelana.

Armonía Black.

PORCELANA

PORCELAIN
PORCELAINE
PORZELAIN
PORCELANA



NEW

Set 12 Piezas Negro

Set 12 Black Pieces
Ensemble de 12 Noir Pièces
Set 12 Stücke Schwarz
Conjunto de 12 Peças Preto

- 4x Plato llano 26,8cm
- 4x Plato hondo 20cm
- 4x Plato postre 19cm
- 4x Flat plate 26,8cm
- 4x Soup plate 20cm
- 4x Dessert plate 19cm

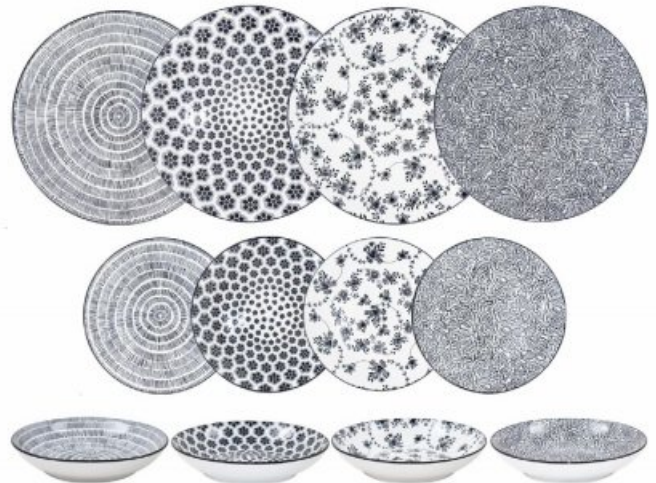

ref.	Ø (cm)		Bar Code
691701	19+20+26,80	2	8411922476125



NEW

Bol Azul Surtido M

Blue Bowl Assorted M
Bol Bleu Assorti M
Schüssel Blau Sortiert M
Tigela Azul Sortida M



ref.	Ø (cm)	H (cm)	ml	☐	Bar Code
691800	11,50	5,50	270	4/24	8411922476132

NEW

Bol Azul Surtido L

Blue Bowl Assorted L
Bol Bleu Assorti L
Schüssel Blau Sortiert L
Tigela Azul Sortida L



ref.	Ø (cm)	H (cm)	ml	☐	Bar Code
691900	15,10	7	610	4/24	8411922476163

NEW

Bol Negro Surtido M

Black Bowl Assorted M
Bol Noir Assorti M
Schüssel Schwarz Sortiert M
Tigela Preto Sortida M



ref.	Ø (cm)	H (cm)	ml	☐	Bar Code
691801	11,50	5,50	270	4/24	8411922476149

NEW

Bol Negro Surtido L

Black Bowl Assorted L
Bol Noir Assorti L
Schüssel Schwarz Sortiert L
Tigela Preto Sortida L



ref.	Ø (cm)	H (cm)	ml	☐	Bar Code
691901	15,10	7	610	4/24	8411922476170

NEW

Bol Verde Surtido M

Green Bowl Assorted M
Bol Vert Assorti M
Schüssel Grün Sortiert M
Tigela Verde Sortida M



ref.	Ø (cm)	H (cm)	ml	☐	Bar Code
691802	11,50	5,50	270	4/24	8411922476156

NEW

Bol Verde Surtido L

Green Bowl Assorted L
Bol Vert Assorti L
Schüssel Grün Sortiert L
Tigela Verde Sortida L



ref.	Ø (cm)	H (cm)	ml	☐	Bar Code
691902	15,10	7	610	4/24	8411922476187

NEW

Mug Surtido Azul

Blue Mug Assorted
Mug Assorti Bleu
Becher Sortiert Blau
Caneca Sortida Azul



ref.	Ø (cm)	H (cm)	ml	☐	Bar Code
692000	8,80	10,40	360	4/24	8411922476194

NEW

Mug Surtido Negro

Black Mug Assorted
Mug Assorti Noir
Becher Sortiert Schwarz
Caneca Sortida Preto



ref.	Ø (cm)	H (cm)	ml	☐	Bar Code
692001	8,80	10,40	360	4/24	8411922476200

NEW

Mug Surtido Verde

Green Mug Assorted
Mug Assorti Vert
Becher Sortiert Grün
Caneca Sortida Verde



ref.	Ø (cm)	H (cm)	ml	☐	Bar Code
692002	8,80	10,40	360	4/24	8411922476217



Bol

JARDIN WHITE



HEXAGON WHITE



LAMAY



OSTROV



HEBAO



HALSON



GOTLAND



TALAI



ACUARIO



REBUN



KUME



LOTO



ref.	∅ (cm)	H (cm)	ml	📦	Bar Code	
687900	16	7,30	700	6/24	8411922460124	JARDIN WHITE
687901	16	7,30	700	6/24	8411922460131	HEXAGON WHITE
687902	16	7,30	700	6/24	8411922460148	LAMAY
687903	16	7,30	700	6/24	8411922460155	OSTROV
687904	16	7,30	700	6/24	8411922460162	HEBAO
687905	16	7,30	700	6/24	8411922460179	HALSON
687906	16	7,30	700	6/24	8411922460186	GOTLAND
687907	16	7,30	700	6/24	8411922460193	TALAI
687908	16	7,30	700	6/24	8411922460209	ACUARIO
687909	16	7,30	700	6/24	8411922460216	REBUN
687910	16	7,30	700	6/24	8411922460223	KUME
687911	16	7,30	700	6/24	8411922460230	LOTO

Bol

ALGARVE



COSTA NOVA



AVEIRO



HEXAGON RED



JARDIN BLUE



NAKURU



ELGON



ORMUZ



MENTHA



SAINT MALÓ



BIARRITZ



VENECIA



ref.	∅ (cm)	H (cm)	ml	📦	Bar Code	
688000	13,40	7,30	550	6/24	8411922460247	ALGARVE
688001	13,40	7,30	550	6/24	8411922460254	COSTA NOVA
688002	13,40	7,30	550	6/24	8411922460261	AVEIRO
688003	13,40	7,30	550	6/24	8411922460278	HEXAGON RED
688004	13,40	7,30	550	6/24	8411922460285	JARDIN BLUE
688005	13,40	7,30	550	6/24	8411922460292	NAKURU
688006	13,40	7,30	550	6/24	8411922460308	ELGON
688007	13,40	7,30	550	6/24	8411922460315	ORMUZ
688008	13,40	7,30	550	6/24	8411922460322	MENTHA
688009	13,40	7,30	550	6/24	8411922460339	SAINT MALÓ
688010	13,40	7,30	550	6/24	8411922460346	BIARRITZ
688011	13,40	7,30	550	6/24	8411922460353	VENECIA

Expositor para Boles

Bowl Display
Support pour Bols
Ständer für Schüsseln
Expositor de Tigelas

ref.	H (cm)	📦	Bar Code
000988	170	1	8411922470338

150 BOWLS



Recipiente de Vapor H-Class

H-Class Steamer
Étui Vapeur H-Class
Dampfbox H-Class
Recipiente de Vapor H-Class



- **Silicona**
- **Explora las oportunidades que ofrece la cocina con microondas**
- **Incluye esterilla/bandeja**
- Silicone
- Explore the opportunities that microwave cooking offers
- Includes mat/tray



ref.	L (cm)	W (cm)	H (cm)	📦	Bar Code
873200	25	17	10	1/6/12	8411922440058

Recipiente de Vapor Rectangular M

Rectangular Steamer M
Étui Vapeur Rectangulaire M
Rechteckiges Dampfbox M
Recipiente de Vapor Rectangular M



- **Silicona**
- Silicone



ref.	L (cm)	W (cm)	H (cm)	Lts	📦	Bar Code
870424	24	15	5	1	1/6/24	8411922083705

Recipiente de Vapor Rectangular XL

Rectangular Steamer XL
Étui Vapeur Rectangulaire XL
Rechteckiges Dampfbox XL
Recipiente de Vapor Rectangular XL



- **Silicona**
- Silicone



ref.	L (cm)	W (cm)	H (cm)	Lts	📦	Bar Code
870428	28	21	8	2,50	1/12	8411922084221

Escalfador de Huevos para Microondas

Microwave Egg Poacher
Pocheuse à Oeuf au Micro-Ondes
Mikrowellen Eier Pochierer
Escalfador de Ovos para Micro-Ondas



- **Plástico**
- Plastic



ref.	L (cm)	W (cm)	H (cm)	📦	Bar Code
730610	22	11	8	1/6/18	8411922448245

Kit para Fiambre Artesano (Microondas)

Artisan Cold Meats Kit (Microwave)
Kit Charcuterie Artisanale (Micro-Ondes)
Set für Handwerkliche Aufschnitt (Mikrowelle)
Kit para Frios Artesanais (Micro-Ondas)



- Borosilicato
- Silicona
- Nylon
- Para aprox. 350g de fiambre
- Borosilicate
- Silicone
- Nylon
- For around 350g of cold meat

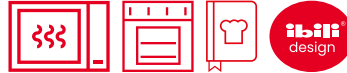

ref.	L (cm)	W (cm)	H (cm)	📦	Bar Code
746700	19	6	6	1/6/36	8411922437140

Kit para 12 Barritas Energéticas Caseras

Home-Made 12 Energy Bars Kit
Kit pour 12 Barres Énergétiques Maison
Set für 12 Selbstgemachte Energieriegel
Kit para 12 Barras Energéticas Caseiras



- Silicona
- Molde + 2 estuches (10cm)
- Silicone
- Mold + 2 cases (10cm)



ref.	L (cm)	H (cm)	📦	Bar Code	
747000	15	7	5/10	8411922437423	PEACH
747001	15	7	5/10	8411922438277	GREEN



Cestillo de Vapor Plegable

Foldable Steam Basket
Panier à Vapeur Pliant
Klappbarer Dampfkorb
Cesto de Vapor Dobrável



- Acero Inoxidable
- Stainless Steel

ref.	∅ (cm)	📦	Bar Code
786922	16-24	6/48	8411922087598

Cestillo de Vapor Plegable Luxe

Luxe Foldable Steam Basket
Panier à Vapeur Pliant Luxe
Klappbarer Dampfkorb Luxe
Cesto de Vapor Dobrável Luxe



- Acero Inoxidable
- Silicona
- Stainless Steel
- Silicone

ref.	∅ (cm)	H (cm)	📦	Bar Code
796127	27	8	6/24	8411922447132

Eliminador de Grasas

Fat Remover
 Eliminateur de Graisse
 Fett-Entferner
 Removedor de Gordura



- Plástico
- Metálico
- Sistema patentado que captura el exceso de grasa de las comidas de forma eficaz
- Incluye eliminador mini
- Plastic
- Metallic
- Patented system that effectively soaks up the excess fat from food
- Includes mini eliminator

ref.	∅ (cm)		Bar Code
776600	9	1/6/24	8411922087864

Separador de Grasas con Filtro / Jarra Medidora

Fat Separator with filter / Measuring Jug
 Séparateur de Graisse avec Filtre / Pichet Mesureur
 Fettabscheider mit Filter / Messbecher
 Separador de Gorduras com Filtro / Jarro de Medição



- Plástico
- Plastic



ref.	Lts		Bar Code
795900	1	6/24	8411922093704

Comida Internacional.

Comida Internacional.

Fondues.

Fondue para Chocolate o Queso

Chocolate/Cheese Fondue
 Fondue pour le Chocolat et le Fromage
 Fondue für Schokolade oder Käse
 Fondue para Chocolate ou Queijo



- Cerámica
- 4 pinchos + 4 velas
- Ceramic
- 4 skewers + 4 candles

ref.	∅ (cm)	Lts	H (cm)		Bar Code
707150	11,50	0,41	14	1/6/12	8411922456349

Espumadera para Fondue

Fondue Skimmer
 Écumoire pour Fondue
 Fondue-Schaumlöffel
 Escumadeira para Fondue



- Acero Inoxidable
- Stainless Steel

ref.	L (cm)		Bar Code
725610	23	12/96	8411922449112

Molde Falafel

Falafel Mold
Moule Falafel
Falafel Form
Forma para Falafel



- **Acero Inoxidable**
- **Falafel: Croqueta a base de garbanzos o habas muy popular en Oriente Medio**
- Stainless Steel
- Falafel: Deep-fried flat ball made from chickpeas or fava beans, very popular in Middle East



ref.	L (cm)	Ø (cm)	📦	Bar Code
705706	14	6	6/72	8411922457131
705710	14	4	6/96	8411922449570

Tajine Hierro Fundido H-Class

H-Class Cast Iron Tajine Pot
Plat à Tajine en Fonte H-Class
Tajine Gusseisen H-Class
Tajine de Ferro Fundido H-Class



- **Cuerpo de hierro fundido con tapa cerámica**
- **Caja reforzada adaptada para la venta online**
- Cast iron body with ceramic lid
- Reinforced box adapted for online sales



ref.	Ø (cm)	H (cm)	📏 (cm)	🌀 (cm)	📦	Bar Code
628727	27	23	18	±2	1	8411922471199

Tajine Natural Marrón

Natural Tajine Pot Brown
Plat à tajine Natural Brune
Tajine Natural Braun
Tajine Natural Castanho



- **Barro Natural Esmaltado**
- **Tapa con orificio**
- **Caja reforzada adaptada para la venta online**
- Natural Glazed Clay
- Lid with hole
- Reinforced box adapted for online sales



ref.	Ø (cm)	H (cm)	📏 (cm)	📦	Bar Code
629028	28	19	20,50	1	8411922474206
629032	32	23	25	1	8411922474213

Tajine Natural Negro

Natural Tajine Pot Brown
Plat à Tajine Naturel Marron
Tajine Natural Braun
Tajine Natural Castanho



- **Barro Natural Esmaltado**
- **Tapa con orificio**
- **Caja reforzada adaptada para la venta online**
- Natural Glazed Clay
- Lid with hole
- Reinforced box adapted for online sales



ref.	Ø (cm)	H (cm)	📏 (cm)	📦	Bar Code
629128	28	19	20,50	1	8411922474220

Vaporera de Silicona

Silicone Steam Case
Coffret Vapeur en Silicone
Silikon Dampfgarer
Caixa de Vapor em Silicone



- Posibilidad de apilar varias unidades
- Possibility of stacking multiple units

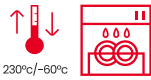

230°C/-60°C

ref.	Ø (cm)	H (cm)	📦	Bar Code
682900	18	10	1/6/18	8411922456639

Vaporera de Bambú

Bamboo Steamer
Cuiseur Vapeur Bambou
Bambusdampfkocher
Vapor de Bambu



ref.	Ø (cm)	H (cm)	📦	Bar Code
727500	20	14,50	1/6	8411922084788
727526	26	16	1/4	8411922475111

NEW

Papel para Vaporera

Steamer Paper
Papier pour Panier Vapeur
Dampfkorbpapier
Papel para Vaporeira



- Papel
- Paper



non-stick

ref.	Ø (cm)	📦	Bar Code
690917	17	12/144	8411922475067
690923	23	12/144	8411922475074

Molde para Sushi

Sushi Mold
Moule à Sushi
Sushi-Förmchen
Forma para Sushi



- Plástico
- Plastic

ref.	L (cm)	📦	Bar Code
773800	22	1/6/24	8411922078954

Molde para Sushi Onigiri

Onigiri Sushi Mold
Moule à Sushi Onigiri
Onigiri-Sushi-Förmchen
Forma para Sushi Onigiri



- Plástico
- Plastic

ref.	L (cm)	W (cm)	📦	Bar Code
773810	12	12	1/6/36	8411922084870

Molde para Sushi Gunkan

Gunkan Sushi Mold
Moule à Sushi Gunkan
Gunkan Sushi-Förmchen
Forma para Sushi Gunkan



- Plástico
- Plastic

ref.	L (cm)	W (cm)	📦	Bar Code
773820	19	7	1/6/36	8411922084887

Prensatorillas

Tortilla Press
 Presse-Tortillas
 Tortilla-Press
 Prensa para Tortilhas



- **Aluminio**
- Aluminium

ref.	Ø (cm)		Bar Code
799820	20	1/6	8411922434576

Soporte para 2/3 Tacos

Holder for 2/3 Tacos
 Support pour 2/3 Tacos
 Taco-Halter (2 oder 3 Stück)
 Suporte para 2/3 Tacos

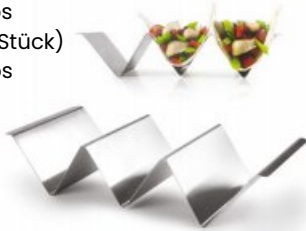

- **Acero Inoxidable**
- Stainless Steel

ref.	L (cm)	W (cm)	H (cm)		Bar Code
687600	21,30	10	5,50	6/72	8411922459845

Tortillero

Tortillas Warmer
 Chauffe-Tortillas
 Tortillakorb
 Recipiente para Tortilhas



- **Plástico**
- **Mantiene las tortillas mexicanas de maíz o de trigo calientes**
- Plastic
- Keeps corn or wheat Mexican tortillas hot

ref.	Ø (cm)	H (cm)		Bar Code
794117	17,50	3,80	6	8411922453669
794122	22	7	6	8411922453676

Soporte para 3/4 Tacos

Holder for 3/4 Tacos
 Support pour 3/4 Tacos
 Taco-Halter (3 oder 4 Stück)
 Suporte para 3/4 Tacos



- **Acero Inoxidable**
- Stainless Steel

ref.	L (cm)	W (cm)	H (cm)		Bar Code
687610	28,50	10	4,50	6/48	8411922470703

Máquina para Pasta Fresca

Fresh Pasta Machine
 Machine à Pâtes Fraîches
 Frische Nudelmaschine
 Máquina de Massa Fresca



- **Acero Cromado**
- **Plástico**
- **Espesor de pasta 0,2-3mm**
- Chrome Steel
- Plastic
- Pasta thickness 0.2-3mm

ref.	L (cm)		Bar Code
773100	17	1/4	8411922078053

Accesorio para Ravioli (para Máquina para Pasta)

Ravioli Accessory (for Pasta Machine)
 Accessoire pour Ravioli (pour Machine à Pâte)
 Ravioli Accessoire (für Pasta-Maschine)
 Acessório Ravioli (para Máquina de Massa)



- **Metálico**
- **Plástico**
- **Solo el accesorio, no incluye la máquina principal**
- Metallic
- Plastic
- Only the accessory, main machine not included

ref.	L (cm)	W (cm)		Bar Code
725404	16	8	1/6/12	8411922082227

Medidor para Pasta

Pasta Measurer
Mesureur de Pâtes
Nudelmessgerät
Medidor de Massas



- **Acero Inoxidable**
- Stainless Steel

ref.	L (cm)		Bar Code
774200	16,50	12/168	8411922079470

Secador para Pasta Fresca Desmontable

Collapsible Fresh Pasta Drying Rack
Séchoir à Pâtes Fraîches Démontable
Pastatrockner, Zerlegbar
Secador Desmontavel para Massa Fresca



- **Madera de Pino**
- Pine Wood

ref.	W (cm)	H (cm)		Bar Code
683900	44,50	42	6	8411922457285

Rodillo Cortador para Ravioli Redondo

Round Ravioli Cutter
Coupe-Raviolis Rond
Ravioli-Ausstecher Rund
Cortador de Ravioli Redondo



- **Acero Inoxidable**
- **Madera de Caucho**
- Stainless Steel
- Rubber Wood



ref.	Ø (cm)		Bar Code
684100	6	6/120	8411922457353

Rodillo Cortador para Ravioli Cuadrado

Square Ravioli Cutter
Coupe-Raviolis Carré
Ravioli-Ausstecher Quadratisch
Cortador de Ravioli Cuadrado



- **Acero Inoxidable**
- **Madera de Caucho**
- Stainless Steel
- Rubber Wood



ref.	L (cm)	W (cm)		Bar Code
684110	6	6	6/120	8411922457360

Rodillo Cortador para Pasta Doble

Double Ravioli Cutter
Coupe-Raviolis Double
Doppelter Ravioli-Ausstecher
Cortador de Ravioli Duplo



- **Acero Inoxidable**
- **Madera de Caucho**
- Stainless Steel
- Rubber Wood



ref.	L (cm)		Bar Code
684120	20	6/144	8411922457377

Tabla para Gnocchi/Garganelli

Gnocchi/Garganelli Board
Planche à Gnocchi/Garganelli
Gnocchi/Garganelli Holbrett
Tabua para Gnocchi/Garganelli



- **Madera de Pino**
- **Madera de Ciprés**
- Pine Wood
- Cypress Wood

ref.	L (cm)	W (cm)		Bar Code
683600	20	6,50	6/96	8411922457032

Molde Ravioli Cuadrado + Rodillo

Square Ravioli Mold + Rolling Pin
 Moule à Ravioli Carré + Rouleau
 Ravioliform Rechteckig + Rolle
 Molde Ravioli Quadrado + Rolo



- Plástico
- Madera de Haya
- Plastic
- Beech Wood



ref.	L (cm)	W (cm)	H (cm)		Bar Code
683000	30	12	2,20	3/6/36	8411922456653

Molde Ravioli Redondo + Rodillo

Round Ravioli Mold+ Rolling Pin
 Moule Raviolis Rond + Rouleau
 Ravioliform Rund + Rolle
 Molde Ravioli Redondo + Rolo



- Plástico
- Madera de Haya
- Plastic
- Beech Wood



ref.	L (cm)	W (cm)	H (cm)		Bar Code
683050	30	12	2,20	3/6/36	8411922456660

Cortador para Raviolis Cuadrado

Square Ravioli Cutter
 Emporte-Pièce de Raviolis Carré
 Ravioli-Ausstecher Quadratisch
 Cortador de Ravioli Quadrado



- Acero Inoxidable 18%
- Stainless Steel 18%

ref.	L (cm)	W (cm)		Bar Code
779400	6	6	6/72	8411922081879

Cortador para Raviolis Redondo

Round Ravioli Cutter
 Emporte-Pièce de Raviolis Rond
 Ravioli-Ausstecher Runder
 Cortador de Ravioli Redondo



- Acero Inoxidable 18%
- Stainless Steel 18%

ref.	∅ (cm)		Bar Code
779401	6	6/72	8411922081886

Piedra para Pizza Redonda

Round Pizza Stone
 Pierre Pizza Ronde
 Runder Pizzastein
 Pedra de Pizza Redonda

- Cerámica Refractaria
- Acero Inoxidable
- Refractory Ceramic
- Stainless Steel



ref.	∅ (cm)		Bar Code
778333	33	1/4	8411922080902

Piedra para Pizza Rectangular

Rectangular Pizza Stone
 Pierre Pizza Rectangulaire
 Rechteckiger Pizzastein
 Pedra para Pizza Retangular

- Cerámica Refractaria
- Acero Inoxidable
- Refractory Ceramic
- Stainless Steel



ref.	L (cm)	W (cm)	H (cm)		Bar Code
784338	38	30	1,10	1/4	8411922435702
784340	41	36	1,50	1/4	8411922084801

Pala-Base para Pizzas y Tartas Redonda

Round Server-Base for Pizza and Cakes
Pelle Base Ronde pour Pizza et Gâteaux
Runder Server-Boden für Pizza und Kuchen
Pá-Base Redonda para Pizza e Bolos



- **Acero Inoxidable**
- Stainless Steel

ref.	∅ (cm)	📦	Bar Code
725200	25	6/24	8411922082203

Pala-Base para Pizzas y Tartas Rectangular

Rectangular Server-Base for Pizza and Cakes
Pelle Base Rectangulaire pour Pizza et Gâteaux
Rechteckige Server-Boden für Pizza und Kuchen
Pá-Base Retangular para Pizza e Bolos



- **Acero Inoxidable**
- Stainless Steel

ref.	L (cm)	W (cm)	📦	Bar Code
781700	37	25	1/6/24	8411922082531

Pala-Base de Madera para Pizza

Wooden Server-Base for Pizza
Pelle-Base en Bois pour Pizza
Pizzateher aus Holz
Casca de Pizza em madeira

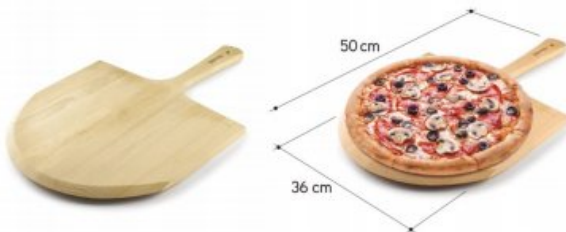

- **Madera de Haya**
- **Las piezas no son totalmente planas, pueden presentar curvaturas debido a que están fabricadas en madera natural**
- Beech Wood
- The items are not completely flat, they may have slight curve because they are made of natural wood



ref.	L (cm)	W (cm)	H (cm)	📦	Bar Code
682700	50	35	1,50	6	8411922455977

Rejilla para Pizza Inox

Stainless Steel Pizza Screen
Grille à Pizza Inox
Pizzablech mit Gitterstruktur aus Edelstahl
Grelha para Pizza Inox



- **Acero Inoxidable**
- Stainless Steel



ref.	∅ (cm)	📦	Bar Code
713830	30	6/96	8411922453928

Rejilla para Pizza Aluminio

Aluminium Pizza Screen
Grille pour Pizza Aluminium
Pizzablech mit Gitterstruktur aus Aluminium
Grelha para Pizza em Aluminio



- **Aluminio**
- Aluminium



ref.	∅ (cm)	📦	Bar Code
715630	30	6/72	8411922451429

Cortapizzas Professional

Professional Pizza Cutter
Roulette à Pizza Professional
Pizza-Scheider Professional
Corta-Pizzas Professional



- **Acero Inoxidable**
- Stainless Steel

ref.	L (cm)	∅ (cm)	📦	Bar Code
680800	15	10	6/96	8411922454413

Cortapizzas Inox

Stainless Steel Pizza Cutter
Roulette à Pizza Inox
Pizzaschneider aus Edelstahl
Cortador de Pizza Inox



- **Acero Inoxidable 18/10**
- Stainless Steel 18/10

ref.	L (cm)	∅ (cm)	📦	Bar Code
761900	20,50	7,50	12/120	8411922621914

Cortapizza Roll'in

Roll'in Pizza Cutter
Roulette à Pizza Roll'in
Pizza-Schneider Roll'in
Corta-pizzas Roll'in



- Acero Inoxidable
- Stainless Steel

ref.	∅ (cm)	L (cm)		Bar Code
733400	8	11	12/48	8411922086836

Cortapizzas Confort

Confort Pizza Cutter
Roulette à Pizza Confort
Pizza-Schneider Confort
Corta Pizzas Confort



- Plástico
- Acero Inoxidable
- Plastic
- Stainless Steel

ref.	L (cm)		Bar Code
739000	18	12/48	8411922093483

Artículos para Pan.

Cuchilla Marcadora para Pan

Bread Marking Knife
Lame pour Entailler le Pain
Markiermesser Fur Brot
Faca Marcadora para Pão



- Acero Inoxidable
- Plástico
- Con protector
- Stainless Steel
- Plastic
- With guard

ref.	L (cm)	W (cm)		Bar Code
681500	15	2	6/144	8411922455540

Panera con Tapa - Tabla de Corte

Bread Bin with Lid - Cutting Board
Conteneur à Pain avec Couvercle - Planche de Découper
Brotkasten mit Deckel - Schneidebrett
Caixa para Pão com Tampa - Tábua de Cortar



- PP
- Bambú
- PP
- Bamboo

ref.	L (cm)	W (cm)	H (cm)		Bar Code
754410	34	18	13	1/6	8411922448498

Panera Baguette

Baguette Bin
Conteneur à Pain Baguette
Baguette-Kasten
Caixa para Baguette



- PP
- Bambú
- PP
- Bamboo

ref.	L (cm)	W (cm)	H (cm)		Bar Code
754420	39,50	15	10	1/6	8411922453614

Panera Inox

Stainless Steel Bread Bin
Conteneur à Pain Inox
Edelstahl-Brotkasten
Caixa para Pão Inox



- Acero Inoxidable
- Stainless Steel

ref.	L (cm)	W (cm)	H (cm)		Bar Code
765410	44	28	17	1/4	8411922440287

Bolsa para Pan

Baguette Bag
Sac à Baguette
Baguette-Tasche
Saco para Baguetes



- Poliéster
- Mantiene el pan fresco más tiempo
- Polyester
- Keeps bread fresh for longer



ref.	L (cm)	W (cm)	📦	Bar Code	
764838	38	27,50	6/48	8411922446135	BREAD BAG
764870	70	19	6/48	8411922446142	BAGUETTE BAG

Cesta para Pan, Fruta y Verdura Rectangular

Rectangular Basket for Bread , Fruit and Vegetables
Panier pour le Pain, les Fruits et les Légumes Rectangulaire
Rechteckiger Korb für Brot, Obst und Gemüse
Cesta para Pão, Frutas e Legumes Rectangular



- Algodón
- Metálico
- Cotton
- Metallic



ref.	L (cm)	W (cm)	H (cm)	📦	Bar Code
705920	20	16	10	6/24	8411922456356
705925	20	18	12	6/24	8411922456363

Cesta para Pan, Fruta y Verdura Redonda

Round Basket for Bread , Fruit and Vegetables
Panier pour le Pain, les Fruits et les Légumes Ronde
Runder Korb für Brot, Obst und Gemüse
Cesta para Pão, Frutas e Legumes Redondo



- Algodón
- Metálico
- Cotton
- Metallic



ref.	∅ (cm)	H (cm)	📦	Bar Code
706020	20	15	6/24	8411922456370
706025	25	18	6/24	8411922456387

NEW

Panera con Forro de Tela

Bread Bin with Fabric Lining
Conteneur à Pain avec Doublure en Tissu
Brotkasten mit Stofffutter
Cesto de Pão com forro de Tecido

- Algodón
- Plástico
- Cotton
- Plastic



ref.	L (cm)	W (cm)	H (cm)	📦	Bar Code
666800	24	19	11	6/12	8411922475081



Cerámica.

Tapa Bambú.

CERÁMICA. BAMBÚ
CERAMIC. BAMBOO
CÉRAMIQUE. BAMBOO
KERAMIK. BAMBUS
CERÂMICA. BAMBOO



Salero Cuadrado

Square Salt Bowl
Salière Carrée
Quadratischer Salzbehälter
Saleiro Quadrado



ref.	L (cm)	W (cm)	H (cm)	Lts		Bar Code
714810	11	11	9,90	0,68	6/24	8411922448146

Salero Cuadrado Negro

Square Black Salt Cellar
Salière Carrée Noir
Quadratischer Salzbehälter, Schwarz
Saleiro Quadrado Preto



ref.	L (cm)	W (cm)	H (cm)	Lts		Bar Code
714810N	11	11	9,90	0,68	6/24	8411922474237

Salero Redondo

Round Salt Bowl
Salière Ronde
Runder Salzbehälter
Saleiro Redondo



ref.	L (cm)	W (cm)	H (cm)	Lts		Bar Code
714805	12	10	11	0,75	6/24	8411922448139

Salero Cuadrado Gris

Square Grey Salt Cellar
Salière Carrée Gris
Quadratischer Salzbehälter, Grau
Saleiro Quadrado Cinzento



ref.	L (cm)	W (cm)	H (cm)	Lts		Bar Code
714810G	11	11	9,90	0,68	6/24	8411922474244

Salero/Azucarero con Cucharilla

Salt/Sugar Bowl Lid with Spoon
Salière/Sucrier avec Cuillère
Salzbehälter/Zuckerdose mit Löffel
Saleiro/Açucareiro com Colher



ref.	L (cm)	W (cm)	H (cm)	Lts		Bar Code
714800	8,80	8,50	9	0,35	6/36	8411922448122

Salero Doble

Double Salt Bowl
Salière Double
Doppelter Salzbehälter
Saleiro Duplo



ref.	L (cm)	W (cm)	H (cm)	Lts		Bar Code
714950	15,60	11	10	6/18		8411922449631

Tarro

Jar
Pot
Topf
Frasco



ref.	Ø (cm)	Lts	H (cm)		Bar Code
715003	9,50	0,30	6,90	4/36	8411922449648
715005	11,50	0,50	7,90	4/24	8411922449655
715010	13,50	1	9,90	4/16	8411922449662

Tarro para Ajos

Garlic Jar
Pot pour l'Ail
Knoblauchtopf
Frasco para Alhos



ref.	Ø (cm)	H (cm)		Bar Code
715110	12	12	4/16	8411922449679



Salero Cuadrado

Square Salt Bowl
Salière Carrée
Quadratischer Salzbehälter
Saleiro Quadrado



ref.	L (cm)	W (cm)	H (cm)	Lts		Bar Code
714850	11	11	9,90	0,68	6/24	8411922448429

Salero Redondo

Round Salt Bowl
Salière Ronde
Runder Salzbehälter
Saleiro Redondo



ref.	L (cm)	W (cm)	H (cm)	Lts		Bar Code
714855	12	10	11	0,75	6/24	8411922449310

Salero/Azucarero con Cucharilla

Salt / Sugar Bowl with Spoon
Salière/Sucrier avec Cuillère
Salzbehälter/Zuckerdose mit Löffel
Saleiro/Açucareiro com Colher



ref.	L (cm)	W (cm)	H (cm)	Lts		Bar Code
714860	8,80	8,50	9	0,35	6/36	8411922449686

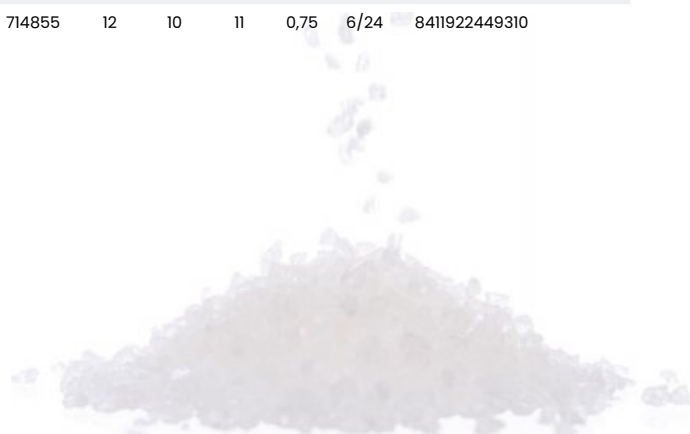

Mantequillera

Butter Dish
Beurrier
Butterdose
Manteigueira



ref.	L (cm)	W (cm)	H (cm)		Bar Code
714900	16,50	10	6	6/24	8411922449624

Salsera

Gravy Boat
Saucière
Saucenschüssel
Molheira



ref.	L (cm)	W (cm)	H (cm)	Lts		Bar Code
715210	20,50	7	13	0,25	6/18	8411922451061

Set Aceitera-Vinagrera-Salero-Pimentero Vintage

Set Vintage Oil and Vinegar Cruet with Salt and Pepper Shaker
Jeu Huilier-Vinaigrier-Salière-Poivrière Vintage
Set Öl und Essig Flasche mit Salz und Pfefferstreuer Vintage
Conjunto Galheteiro de Óleo/Vinagre-Saleiro-Pimenteiro Vintage

ref.	Lts		Bar Code
715310	0,34	6	8411922451078



Set Salero Pimentero Vintage

Vintage Salt and Pepper Shaker Set
Set de Salière et Poivrière Vintage
Set Salz und Pfefferstreuer Vintage
Conjunto de Saleiro e Pimenteiro Vintage



ref.	L (cm)	W (cm)	H (cm)		Bar Code
715311	3,50	3,50	7,50	6/48	8411922451085

Botella Vinagre Andalus

Andalus Vinegar Bottle
Vinaigrier Andalus
Essigflasche Andalus
Garrafa Vinagre Andalus



ref.	∅ (cm)	H (cm)	Lts		Bar Code
715313	7,30	21	0,40	6/36	8411922451108

Botella Vinagre Alhambra

Alhambra Vinegar Bottle
Vinaigrier Alhambra
Essigflasche Alhambra
Garrafa Vinagre Alhambra



ref.	∅ (cm)	H (cm)	Lts		Bar Code
715315	8	23,50	0,50	6/24	8411922451122

Botella Aceite Alhambra

Alhambra Oil Bottle
Bouteille Huile Alhambra
Ölflasche Alhambra
Garrafa Azeite Alhambra



ref.	∅ (cm)	H (cm)	Lts		Bar Code
715314	8	23,50	0,50	6/24	8411922451115



Aceiteras y Recicladores de Aceite.



Aceiteras y Recicladores de Aceite.

Recicladores de Aceite.

Reciclador de Aceite H-Class

H-Class Oil Recycler
 Recycleur d'Huile H-Class
 Ölrecycler H-Class
 Reciclador de Azeite H-Class



MEAT



FISH



- **Borosilicato**
- **Filtro de malla superfino de acero inoxidable**
- Borosilicate
- Superfine stainless steel mesh filter



ref.	∅ (cm)	H (cm)	Lts	∅	Bar Code	
743500	10	12,50	0,50	1/6/24	8411922439793	CARNE/MEAT
743510	10	12,50	0,50	1/6/24	8411922439809	PESCADO/FISH

Reciclador de Aceite Square

Square Oil Recycler Square
Recycleur d'Huile Square
Ölrecycler Square
Reciclador de Azeite Square



- **Borosilicato**
- **Filtro de malla superfino de acero inoxidable**
- Borosilicate
- Superfine stainless steel mesh filter



ref.	L (cm)	W (cm)	H (cm)	Lts	📦	Bar Code	
743550	10	10	12	0,60	1/6/24	8411922451405	CARNE/MEAT
743560	10	10	12	0,60	1/6/24	8411922451412	PESCADO/FISH

Recuperador de Aceite Luxe

Luxe Cooking Oil Strainer Pot
Récupérateur d'Huile Luxe
Ölauffangbehälter Luxe
Recuperador de Óleo de Cozinhar Luxe



- **Acero Inoxidable 18/10**
- **Filtro Inox**
- Stainless Steel 18/10
- Stainless Steel Filter

ref.	Ø (cm)	H (cm)	📦	Bar Code	
714400	10	0,75	6/24	8411922079616	CARNE/MEAT
714401	10	0,75	6/24	8411922080063	PESCADO/FISH

Grasera Promo

Promo Oil Strainer
Pot à Huile Promo
Küchen Ölfilter Promo
Aproveitador de Azeite Promo



- **Acero Inoxidable**
- Stainless Steel

ref.	Lts	📦	Bar Code	
700001	0,50	6/48	8411922161663	CARNE/MEAT
700002	0,50	6/48	8411922161670	PESCADO/FISH

Grasera Clásica

Clásica Oil Strainer
Pot à Huile Clásica
Küchen Ölfilter Clásica
Aproveitador de Azeite Clásica



- **Acero Inoxidable 18/10**
- Stainless Steel 18/10

ref.	Lts	📦	Bar Code	
700201	0,50	6/36	8411922604016	CARNE/MEAT
700202	0,50	6/36	8411922604023	PESCADO/FISH
700203	1	6/24	8411922604030	CARNE/MEAT
700204	1	6/24	8411922604047	PESCADO/FISH

Aceitera Clásica

Clásica Oil Can
Huillier Clásica
Ölkännchen Clásica
Almotolia Clásica



- **Acero Inoxidable 18%**
- Stainless Steel 18%

ref.	Lts		Bar Code
700105	0,50	6/36	8411922603507
700107	0,70	6/24	8411922603750
700112	1,20	6/18	8411922603125

Aceitera Oliva

Oliva Oil Can
Huillier Oliva
Ölkännchen Olive
Almotolia Oliva



- **Acero Inoxidable 18/10**
- Stainless Steel 18/10

ref.	Lts		Bar Code
705005	0,50	1/16	8411922072532

Aceitera Ibérica

Iberica Oil Can
Huillier Iberica
Ölkännchen Iberica
Almotolia Iberica



- **Acero Inoxidable**
- Stainless Steel

ref.	Lts		Bar Code
709703	0,30	1/6	8411922077520
709705	0,50	1/6	8411922077544
709710	1	1/6	8411922077537

Aceitera Antigoteo Óptima

Anti-Drip Oil Container
Huiler Anti-Goutte Optima
Anti-Tropf-Ölbehälter Optima
Almotolia Anti-Gotejo Optima



Aceitera Virgen

Virgin Olive Oil Can
Huillier Virgen
Ölkännchen Virgen
Almotolia Virgen



- **Acero Inoxidable 18/10**
- Stainless Steel 18/10

ref.	H (cm)	Lts		Bar Code
705205	15	0,50	1/16	8411922434149

Aceitera Arbequina

Arbequina Oil Can
Huillier Arbequina
Ölkännchen Arbequina
Almotolia Arbequina



- **Acero Inoxidable 18/10**
- Stainless Steel 18/10

ref.	Lts		Bar Code
705105	0,50	1/16	8411922072549

Aceitera Antigoteo

Anti-Drip Oil Container
Huillier Anti-Goutte
Anti-Tropf-Ölbehälter
Almotolia Anti-Gotejo



- **Acero Inoxidable**
- ***No disponible en Portugal**
- Stainless Steel
- ***Not available in Portugal**

ref.	Lts		Bar Code
731702	0,25	6/24	8411922086157
731705	0,50	6/24	8411922086164
731707	0,75	6/24	8411922086171
731710	1	6/12	8411922436532

- **Acero Inoxidable**
- **Plástico**
- Stainless Steel
- Plastic

ref.	Lts		Bar Code
745605	0,50	1/6/24	8411922436662
745610	1	1/6/12	8411922436679

Aceitera Probeta

Probeta Oil Cruet
Huillier Éprouvette
Reagenzglas Ölkanne
Almotolia Proveta



• **Borosilicato**

• Borosilicate

ref.	Lts		Bar Code
755001	0,15	6/24	8411922086652
755002	0,25	6/24	8411922080919
755005	0,50	6/12	8411922080926
755010	1	6/12	8411922080933

Alcuza Oli D'Oliva

Oli D'Oliva Oil Can
Huillier Oli D'Oliva
Ölkanne Oli D'Oliva
Almotolia Oli D'Oliva



• **Borosilicato**

• Borosilicate

ref.	ml		Bar Code
628002	250	6/48	8411922470390
628005	500	6/24	8411922470406
628007	750	6/18	8411922470413

Aceitera Probeta Bombada

Round Oil Cruet
Huillier Bombé
Ölkanne in Bombenform
Almotolia Arredondada



• **Borosilicato**

• Borosilicate

ref.	Lts		Bar Code
751215	0,15	6/24	8411922441468
751230	0,30	6/24	8411922441475
751250	0,50	6/12	8411922071054

Aceitera Probeta Cilindrica

Cylindrical Oil Cruet
Huillier Cylindrique
Zylindrischer Ölkanne
Almotolia Cilindrica



• **Borosilicato**

• Borosilicate

ref.	Lts		Bar Code
751325	0,25	6/24	8411922441505
751350	0,35	6/24	8411922071078

Aceitera Probeta Cuadrada

Square Oil Cruet
Huiler Carré
Quadratische Ölkanne
Almotolia Cuadrada



• **Borosilicato**

• Borosilicate

ref.	Lts		Bar Code
795612	0,125	6/24	8411922093650
795625	0,25	6/24	8411922093667
795650	0,50	6/12	8411922093674

Aceitera Probeta Piramidal

Pyramidal Oil Cruet
Huillier Pyramidal
Ölkanne in Pyramidenform
Almotolia Piramidal



• **Borosilicato**

• Borosilicate

ref.	Lts		Bar Code
746902	0,25	6/24	8411922437232
746905	0,50	6/24	8411922437249

Aceitera Probeta Balón

Round-Bottomed Oil Cruet
Huillier Ballon
Ölkanne in Kugelform
Almotolia Balão



• **Borosilicato**

• Borosilicate

ref.	Lts		Bar Code
752302	0,25	6/24	8411922448443
752305	0,50	6/12	8411922448450

Aceitera Probeta Matraz

Conical Oil Cruet
Huillier Conique
Konische Ölkanne
Almotolia Cónica



• **Borosilicato**

• Borosilicate

ref.	Lts		Bar Code
753202	0,25	6/24	8411922448467
753205	0,50	6/12	8411922448474

Aceitera Antigoteo Sanna

Sanna Anti-Drip Oil Container
Huillier Anti-Goutte Sanna
Nicht Tropfende Ölkanne Sanna
Almotolia Anti-Gotejo Sanna

- **Borosilicato**
- **Tapa de plástico y silicona**
- **Sistema de recogida de gota**
- Borosilicate
- Plastic and silicone lid
- Drip collection system



ref.	ml	∅ (cm)	H (cm)	∅	Bar Code
688702	250	6	19,50	6/48	8411922474633
688705	500	7,50	24	6/48	8411922470680

Aceitera Probeta Art

Art Oil Cruet
Huillier Éprouvette Art
Ölflasche Art
Almotolia Proveta Art

- **Borosilicato**
- Borosilicate



ref.	ml	H (cm)	∅	Bar Code
754303	350	21,50	6/24	8411922470666
754305	500	22,50	6/24	8411922470673

Aceitera con Tapa Basculante

Tilting Lid Oil Bottle
Huillier avec Couvercle Basculante
Öl-Spender mit Neigeöffnung
Almotolia com Tampa Basculante

- **Borosilicato**
- **Acero Inoxidable**
- **Con graduación**
- Borosilicate
- Stainless Steel
- With graduation



ref.	∅ (cm)	H (cm)	Lts	∅	Bar Code
684035	6,50	20	0,35	6/48	8411922457339
684050	6,50	25	0,50	6/48	8411922457346

Aceitera de Boca Ancha Baena

Baena Wide Mouth Oil Dispenser
Huillier à Bec Large Baena
Ölkrug mit Weiter Öffnung Spout Baena
Dispensador de Azeite de Boca Larga Baena

- **Borosilicato**
- **Tapón de silicona**
- Borosilicate
- Silicone cover



ref.	Lts	H (cm)	∅	Bar Code
687110	1	21	6	8411922459593

Pulverizador para Aceite-Vinagre Doble

Double Vinegar-Oil Sprayer
Pulvérisateur Huile-Vinaigre Double
Doppelter Öl-Essig-Sprüher
Pulverizador de Óleo e Vinagre Duplo

- **Plástico**
- **Acero Inoxidable**
- Plastic
- Stainless Steel



ref.	Lts	∅	Bar Code
790300	0,20	1/6/24	8411922090505

Pulverizador para Aceite

Oil Sprayer
Pulvérisateur D'Huile
Ol spray
Azeitera Spray



- Vidrio
- Por bombeo
- Glass
- By pumping

ref.	Lts		Bar Code
701117	0,17	6/36	8411922448436

Aceitera 2 Usos (Spray - Vertedor)

Oil Cruet 2 Uses (Spray - Pourer)
Huilier 2 Fonctions (Vaporisateur + Verseur)
Ölkrug 2 Verwendungen (Spray - Ausgießer)
Dispensador de Azeite 2 Usos (Pulverizar + Verter)



- Plástico
- Plastic

ref.	Lts	H (cm)		Bar Code
741100	0,20	17	1/6/48	8411922435153

Set 2 Aceiteras Eco

Set 2 Eco Oil Cruet
Jeu 2 Huiliers Eco
Set 2 Ölkännchen Eco
Jogo 2 Almotolias Eco



- Vidrio
- Glass

ref.	Lts		Bar Code
713302	0,25	6/12	8411922453935

NEW

Vaporizador de Aceite Eco

Eco Oil Spray
Vaporisateur d'Huile Eco
Ölspray Eco
Azeitera Spray Eco



- Vidrio
- Acero Inoxidable
- Por bombeo
- Glass
- Stainless Steel
- By pumping

ref.	ml	H (cm)	W (cm)		Bar Code
701218	180	15,20	5,60	6/36	8411922475173



Dispensadores.

Set Vinagreras 4 Piezas

Cruet Set 4 Pieces
Jeu Vinaigriers 4 Pièces
Set 4 Essig Flasche
Galheteiro 4 Peças



- **Acero Inoxidable 18%**
- **Vidrio**
- Stainless Steel 18%
- Glass

ref.	Lts		Bar Code
768500	4	1/6	8411922209297

Set Vinagreras 2 Piezas

Cruet Set 2 Pieces
Jeu Vinaigriers 2 Pièces
Set 2 Essig Flasche
Galheteiro 2 Peças



- **Acero Inoxidable 18%**
- **Vidrio**
- Stainless Steel 18%
- Glass

ref.	Lts		Bar Code
768600	0,175	1/6	8411922209303

Vinagrera Display

Vinegar Bottle Display
Vinaigrier Display
Essigkrug Display
Galheteiro Display



- **Acero Inoxidable 18%**
- **Vidrio**
- Stainless Steel 18%
- Glass

ref.	Lts		Bar Code
755200	0,175	6/48	8411922069563

Recambio Botella Salero

Salt Shaker Replacement
Salière de Rechange
Salzstreuer Nachfüllpackung
Reposição de Saleiro



- **Acero Inoxidable 18%**
- **Vidrio**
- Stainless Steel 18%
- Glass

ref.	Lts		Bar Code
769911	0,0375	24/72	8411922072242

Set Salero-Pimentero

Salt-Pepper Shaker Set
Jeu Salière-Poivrière
Salz-Pfefferstreuer Set
Jogo Saleiro-Pimenteiro



- **Acero Inoxidable 18%**
- **Vidrio**
- Stainless Steel 18%
- Glass

ref.	Lts		Bar Code
768700	0,0375	1/6	8411922209310

Set Salero-Pimentero Pequeños

Small Salt-Pepper Shaker Set
Jeu Petite Salière-Poivrière
Salz-Pfefferstreuer-Set Klein
Jogo Saleiro-Pimenteiro Pequeno



- **Acero Inoxidable 18%**
- **Vidrio**
- Stainless Steel 18%
- Glass

ref.	Lts		Bar Code
768715	0,0375	1/24/72	8411922069662

Salero Grande Display

Large Salt Shaker Display
Grande Salière Display
Großes Salzstreuer Display
Saleiro grande Display



- **Acero Inoxidable 18%**
- **Vidrio**
- Stainless Steel 18%
- Glass

ref.	Lts		Bar Code
755100	0,075	12/96	8411922069549

Salero/Pimentero Pequeño

Small Salt-Pepper Shaker
Petite Salière-Poivrière
Salz-Pfefferstreuer Klein
Saleiro-Pimenteiro Pequeno



- **Acero Inoxidable 18%**
- **Vidrio**
- Stainless Steel 18%
- Glass

ref.	Lts		Bar Code
768710	0,0375	12/96	8411922069655

Dispensador de Queso Eco

Eco Cheese Dispenser
Distributeur de Fromage Eco
Käsespender Eco
Dispensador de Queijo Eco



- Acero Inoxidable 18%
- Vidrio
- Stainless Steel 18%
- Glass

ref.	Lts		Bar Code
755400	0,25	1/6/48	8411922069594

Dispensador de Azúcar Eco

Eco Sugar Dispenser
Distributeur de Sucre Eco
Zuckerspender Eco
Dispensador de Açúcar Eco



- Acero Inoxidable 18%
- Vidrio
- Stainless Steel 18%
- Glass

ref.	Lts		Bar Code
755500	0,25	1/6/48	8411922069617

Azucarero con Cucharilla Display

Sugar Bowl with Spoon Display
Sucrier avec Cuillère Display
Zuckerdose mit Löffel Display
Açucareiro com Colher Display



- Acero Inoxidable 18%
- Vidrio
- Stainless Steel 18%
- Glass

ref.	Lts		Bar Code
768800	0,20	1/6	8411922209327

Dispensador de Miel Eco

Eco Honey Dispenser
Distributeur de Miel Eco
Honigspender Eco
Dispensador de Mel Eco



- ABS
- Vidrio
- ABS
- Glass

ref.	Lts		Bar Code
755300	0,25	1/6/48	8411922069570

Dispensador de Queso Eco Display

Eco Cheese Dispenser Display
Distributeur de Fromage Eco Display
Käsespender Eco Display
Dispensador de Queijo Eco Display



- Acero Inoxidable 18%
- Vidrio
- Stainless Steel 18%
- Glass

ref.	Lts		Bar Code
755405	0,25	6/48	8411922069600

Dispensador de Azúcar Eco Display

Eco Sugar Dispenser Display
Distributeur de Sucre Eco Display
Zuckerspender Eco Display
Dispensador de Açúcar Eco Display



- Acero Inoxidable 18%
- Vidrio
- Stainless Steel 18%
- Glass

ref.	Lts		Bar Code
755505	0,25	6/48	8411922069624

Salero Cónico Display

Conical Salt Shaker Display
Salière Conique Display
Konisches Salzstreuer-Display
Saleiro Cónico Display



- Acero Inoxidable
- Stainless Steel

ref.	L (cm)		Bar Code
743900	11	12/120	8411922436235

Dispensador de Miel Eco Display

Eco Honey Dispenser Display
Distributeur de Miel Eco Display
Honigspender Eco Display
Dispensador de Mel Eco Display



- ABS
- Vidrio
- ABS
- Glass

ref.	Lts		Bar Code
755305	0,25	6/48	8411922069587

Bandejas y Bols.

Bandeja I-Chef

Oval Platter
Plat Ovale
Tablett Oval
Bandeja Oval



- Acero Inoxidable 18%
- Stainless Steel 18%



0,5 mm

ref.	L (cm)	W (cm)		Bar Code
700825	25	17	1/6/24	8411922453072
700830	30	20	6/24	8411922453089
700835	35	25	6/24	8411922453096
700840	40	28	6/24	8411922453102

Bandeja de Cambios

Change Tray
Plateau de Changements
Wechselgeld Tablett
Bandeja de Troco



- Acero Inoxidable
- Stainless Steel

ref.	L (cm)	W (cm)		Bar Code
721917	17	10,50	6/72	8411922080018

Bol Alto Satin

Satin Tall Bowl
Bol Haut Satin
Hohe Schale Satin
Tigela Alta Satin



- Acero Inoxidable
- Stainless Steel

ref.	∅ (cm)	H (cm)	Lts		Bar Code
730514	14	7,50	0,70	6/48	8411922452518
730518	18	10	1,40	6/24	8411922448207
730520	20	11	2,30	6/24	8411922452525
730522	22	12	2,80	6/24	8411922448214
730526	26	14	4,70	6/24	8411922448221
730530	30	16	7,90	6/12	8411922448238

Bol Inox Clásica

Clásica Stainless Steel Bowl
Bol Inox Clásica
Edelstahl Schüssel Clásica
Tigela Inox Clásica



- Acero Inoxidable
- Stainless Steel

ref.	∅ (cm)	Lts		Bar Code
710112	12	0,35	6/120	8411922423396
710116	16	0,70	6/120	8411922622072
710119	19	1	6/72	8411922622089
710124	24	2,50	6/60	8411922622096
710129	29	4,50	6/36	8411922622102

Bol Repostería Antideslizante

Non-Slip Pastry Bowl
Bol à Pâtisserie Antidérapant
Rutschfeste Backschüssel
Tigela de Pastelería Antiderrapante



- Plástico
- Plastic

ref.	∅ (cm)	Lts		Bar Code
726618	18	11,50	6/24	8411922083651
726624	24	3	6/24	8411922083668

Bol Inox Bistrot

Bistrot Stainless Steel Bowl
Bol Inox Bistrot
Edelstahl Schale Bistrot
Tigela Inox Bistrot



• Acero Inoxidable

• Stainless Steel

ref.	Ø (cm)	Lts	📦	Bar Code
717008	8	0,16	6/144	8411922449983
717012	12	0,50	6/24	8411922076950
717014	14	0,60	6/24	8411922076967
717016	16	0,90	6/24	8411922076974
717018	18	1,30	6/24	8411922076981
717020	20	2	6/24	8411922076998
717022	22	2,60	6/24	8411922077032
717025	25	4	6/12	8411922077131
717030	30	6	6/12	8411922077230

Bol Semicircular Plegable

Semicircular Folding Bowl
Bol Semi-Circulaire Pliable
Runde Faltbar Schüssel
Tigela Semicircular Dobrável



• Silicona

• Silicone



ref.	Ø (cm)	📦	Bar Code
873000	21	6/24	8411922093520



Bamboo Natural.



- Para alimentos secos
- Natural o lacado en color
- For dry food
- Natural or laquered colour



Bowl / Tazón

Bowl
Bol / Grande Tasse
Schüssel / Trinkschale
Tigela / Taça



ref.	Ø (cm)	H (cm)	Lts		Bar Code
590000	15	7,50	0,60	6/36	8411922470895

Bowl Turquesa Mate

Bowl in Matte Turquoise
Bol Turquoise Mat
Schüssel Matttürkis
Tigela Turquesa Mate



ref.	Ø (cm)	H (cm)	Lts		Bar Code
590300	14	8	0,60	6/36	8411922470956
590400	25	13	3	6/24	8411922470963

Bowl

Bowl
Bol
Schüssel
Tigela

ref.	Ø (cm)	H (cm)	Lts		Bar Code
590600	15	7,50	0,60	6/36	8411922471007
590601	15	7,50	0,60	6/36	8411922471014
590200	15	6	0,50	6/36	8411922470932
590700	16	7,50	0,70	6/36	8411922471021
590201	15	6	0,50	6/36	8411922470949
590701	16	7,50	0,70	6/36	8411922471038



NATURAL
CEREZA BRILLO
BLANCO MATE
BLANCO MATE
GRIS MATE
GRIS MATE





Fuente

Platter
Plat
Platte
Travessa

ref.	∅ (cm)	H (cm)	Lts	📦	Bar Code	
590100	25	8	2,50	6/24	8411922470901	NATURAL
590101	25	8	2,50	6/24	8411922470918	MOSTAZA BRILLO
590102	25	8	2,50	6/24	8411922470925	CEREZA BRILLO



natural



mostaza brillo



cereza brillo



Cuenco

Bowl
Coupelle
Schale
Taça

ref.	∅ (cm)	H (cm)	Lts	📦	Bar Code	
590500	15	6	0,50	6/36	8411922470970	NATURAL
590501	15	6	0,50	6/36	8411922470987	MOSTAZA BRILLO
590502	15	6	0,50	6/36	8411922470994	CEREZA BRILLO



natural



mostaza brillo



cereza brillo



Bandeja Redonda Gris Mate

Round Bowl in Matte Grey
Plateau Rond Gris Mat
Rundes Tablett Mattgrau
Bandeja Redonda Cinzento Mate



ref.	∅ (cm)	H (cm)	📦	Bar Code
590800	35	4,50	6	8411922471045

Coladores y Escurridores.

Colador Malla Media Bola

Half Ball Mesh Strainer
Passoire à Maille Demi-Boule
Netz Halbkugel-Sieb
Coador de Rede Meia Bola



- **Acero Inoxidable 18/10**
- **Stainless Steel 18/10**

ref.	∅ (cm)	📦	Bar Code
703807	7,50	6/96	8411922069679
703810	10	6/72	8411922069686
703812	12,50	6/36	8411922069693
703815	15	6/36	8411922069709
703818	18	6/24	8411922069716
703820	20	6/24	8411922069723

Colador Malla Cónico

Conical Mesh Strainer
Passoire à Maille Conique
Sieb mit Konischem Netz
Coador de Rede Cónico



- **Acero Inoxidable 18/10**
- **Stainless Steel 18/10**

ref.	∅ (cm)	📦	Bar Code
703907	7,50	6/96	8411922069730
703910	10	6/72	8411922069747
703915	15	6/36	8411922069761

Colador Media Bola Eco

Eco Half Ball Strainer
Passoire Demi-Boule Eco
Halbkugel-Sieb Eco
Coador Meia Bola Eco



- **Acero Inoxidable 18/10**
- **Stainless Steel 18/10**

ref.	∅ (cm)	📦	Bar Code
703007	7	6/96	8411922451825
703008	8	6/96	8411922451832
703010	10	6/96	8411922451849
703012	12	6/96	8411922451856
703014	14	6/48	8411922451863
703015	15	6/48	8411922451870
703016	16	6/36	8411922451887
703018	18	6/36	8411922451894
703020	20	6/24	8411922451900
703022	22	6/48	8411922451917
703025	25	6/18	8411922451924

Colador Malla Media Bola Clásica

Clasica Half Ball Mesh Strainer
Passoire à Maille Demi-Boule Clasica
Netz Halbkugel-Sieb Clasica
Coador de Rede Meia Bola Clásica



- **Acero Inoxidable 18/10**
- **Stainless Steel 18/10**

ref.	∅ (cm)	📦	Bar Code
704007	7	6/96	8411922069778
704008	8	6/96	8411922069785
704009	9	6/72	8411922069792
704010	10	6/72	8411922069808
704012	12	6/36	8411922069815
704014	14	6/36	8411922069822
704016	16	6/24	8411922069839
704018	18	6/24	8411922069846
704020	20	6/24	8411922069853

Colador Malla Plástica

Plastic Mesh Strainer
Passoire Maille Plastique
Plastiksieb
Coador de Malha Plástica



- **Plástico**
- **Plastic**

ref.	L (cm)	📦	Bar Code
734300	8	6/24	8411922087925
734310	10	6/24	8411922090468
734314	14	6/24	8411922090475

Escurridor Extensible de Malla

Extendable Mesh Strainer
Passoire Extensible en Maille Métallique
Ausziehbares Maschensieb
Escorredor Extensível de Rede



- **Acero Inoxidable**
- **Regulable**
- **Stainless Steel**
- **Adjustable**

ref.	L (cm)	W (cm)	H (cm)	📦	Bar Code
703834	34-50	24	11	2/6	8411922471113

Colador Chino

Chinese Strainer
Passoire Chinois
Chinesisches Sieb
Coador Chinês



- **Acero Inoxidable**
- Stainless Steel

ref.	∅ (cm)	📦	Bar Code
716816	16	6/36	8411922073539
716818	18	6/24	8411922077704
716820	20	6/12	8411922077711

Escurreidor Acero

Steel Drainer
Égouttoir en Acier
Stahl Küchensieb
Escorredor em Aço



- **Acero Inoxidable**
- Stainless Steel

ref.	∅ (cm)	📦	Bar Code
714620	20	6/24	8411922452969
714624	24	4/16	8411922204179

Escurreidor Acero Clásica Mini

Clásica Mini Steel Drainer
Mini Égouttoir Acier Clásica
Stahl Küchensieb Clásica Mini
Escorredor em Aço Clásica Mini



- **Acero Inoxidable**
- Stainless Steel

ref.	∅ (cm)	📦	Bar Code
711114	14	6/72	8411922204407

Colador Clásica

Clásica Strainer
Passoire Clásica
Küchensieb Clásica
Coador Clásica



- **Acero Inoxidable**
- Stainless Steel

ref.	∅ (cm)	📦	Bar Code
711020	20	6/48	8411922262218

Mano para Chino

Chinese Strainer Pusher
Pilon pour Chinois
Chinesische Hand
Mão para Coador Chinês



- **Madera de Arce**
- Maple Wood



ref.	L (cm)	W (cm)	📦	Bar Code
729400	26	4	6/96	8411922439908

Colador

Strainer
Passoire
Küchensieb
Coador



- **Acero Inoxidable**
- Stainless Steel

ref.	∅ (cm)	📦	Bar Code
714720	20	4/16	8411922204186

Escurreidor Acero Clásica

Clásica Steel Drainer
Égouttoir Acier Clásica
Stahl Küchensieb Clásica
Escorredor em Aço Clásica



- **Acero Inoxidable**
- Stainless Steel

ref.	∅ (cm)	📦	Bar Code
711124	24	6/24	8411922622225

Escurreidor para Ollas

Strainer for Pots
Passoire pour Faitout
Sieb für Töpfe
Escorredor para Tachos



- **Acero Inoxidable**
- Stainless Steel

ref.	∅ (cm)	📦	Bar Code
728100	26	6/36	8411922084948

Harinero

Flour Container
Tamis à Farine
Mehlsieb
Peneira para Farinha



- **Acero Inoxidable**
- Stainless Steel

ref.	L (cm)	W (cm)	📦	Bar Code
718300	25	20	1/4	8411922078725

Harinero con Tapa Confort

Confort Flour Bin Mesh with Lid
Tamis à Farine avec Couvercle Confort
Mehlstreuer mit Deckel Confort
Peneira para Farinha com Tampa Confort



- **Plástico**
- Plastic

ref.	L (cm)	W (cm)	H (cm)	📦	Bar Code
755600	27,50	22	5,50	1/6/12	8411922447118

Pasapurés Luxe 3 Discos

Luxe Food Mill 3 Sieves
Presse-Purée Luxe 3 Disque
Passiergerät Luxe 3 Scheiben
Passe Vite Luxe 3 Discos



- **Acero Inoxidable 18/10**
- **Nylon**
- Stainless Steel 18/10
- Nylon

ref.	∅ (cm)	H (cm)	📦	Bar Code
742420	20	8,50	1/6	8411922435429
742424	24	10	1/4	8411922435436

Pasapurés con 3 Discos Clásica

Clásica Food Mill with 3 Discs
Presse Purée avec 3 Disques Clásica
Lebensmittelmühle mit 3 Scheiben Clásica
Passe Vite com 3 Discos Clásica



- **Acero Inoxidable 18/10**
- Stainless Steel 18/10

ref.	∅ (cm)	📦	Bar Code
765320	20	6	8411922206395
765324	24	6	8411922206401

Pasapurés Plástico 1 Disco

Plastic Food Mill 1 Disc
Presse Purée Plastique 1 Disque
Kunststoff-Lebensmittelmühle 1 Scheibe
Passe Vite Plástico 1 Disco



- **Plástico**
- Plastic

ref.	∅ (cm)	📦	Bar Code
709320	20	6	8411922076936

Pasador de Frutas

Coulis Sieve
Passoire à Coulis
Coulis-Sieb
Coador de Frutas



- **Acero Inoxidable**
- Stainless Steel

ref.	∅ (cm)	📦	Bar Code
727220	20	6/18	8411922083798

Conservación.



Conservador para Frutas y Verduras

Fruit and Vegetable Preserver
 Conservateur de Fruits et Légumes
 Obst- und Gemüsekonservierer
 Conservador de Frutas y Verduras

+fresco



- Plástico
- Fabricado en EU
- Conserva tus frutas y verduras frescas durante más tiempo, eliminando el gas de etileno de su entorno para ralentizar su maduración y envejecimiento
- Para nevera o frutero
- Incluye libro informativo
- KIT CARCASA + 4 SOBRES (6 MESES)
- Plastic
- Manufactured in EU
- Keep your fruit and vegetables fresh for longer by absorbing ethylene gas from the environment and slow down the ripening and ageing process
- For fridge or fruit basket
- Information leaflet included
- KIT BOX + 4 SACHETS (6 MONTHS)



ref.	∅ (cm)	H (cm)	📦	Bar Code
699900	10	6	12/36	8411922456424

Recambio Conservador para Frutas y Verduras

Fruit and Vegetable Preserver Refill
 Recharge pour Conservateur de Fruits et Légumes
 Austausch für Obst- und Gemüsekonservierer
 Reposição para Conservador de Frutas y Verduras

- Tyvek
- Fabricado en EU
- RECAMBIOS/ 8 SOBRES (12 MESES)
- Tyvek
- Manufactured in EU
- REFILL / 8 SACHETS (12 MONTHS)



ref.	📦	Bar Code
699910	12/36	8411922456677



Táper Rectangular

Rectangular Food Container
 Conteneur Alimentaire Rectangulaire
 Rechteckiger Lebensmittelbehälter
 Recipiente Retangular para Alimentos



ref.	L (cm)	W (cm)	H (cm)	Lts	☐	Bar Code
754704	15	10	5	0,40	4/24	8411922445084
754709	18,20	13,50	6,30	0,90	4/12	8411922445091
754710	19,50	14,50	7	1,05	4/12	8411922449426
754716	21,50	15,30	8,30	1,60	4/12	8411922445107

Táper Cuadrado

Square Food Container
 Conteneur Alimentaire Carré
 Quadratischer Lebensmittelbehälter
 Recipiente Quadrado para Alimentos



ref.	L (cm)	W (cm)	H (cm)	Lts	☐	Bar Code
754804	11,50	11,50	6,50	0,45	4/24	8411922445114
754807	14	14	7,20	0,75	4/24	8411922449433
754810	15	15	8	1	4/16	8411922445121

Táper Redondo

Round Food Container
 Conteneur Alimentaire Rond
 Runder Lebensmittelbehälter
 Recipiente Redondo para Alimentos



ref.	∅ (cm)	H (cm)	Lts	☐	Bar Code
755104	11,50	6,60	0,37	4/24	8411922452129
755106	14,70	7,30	0,61	4/24	8411922452136
755108	14,80	8,10	0,80	4/24	8411922452143

Táper Alto Rectangular

Tall Rectangular Food Container
 Conteneur Alimentaire Haut Rectangulaire
 Hoher Rechteckiger Lebensmittelbehälter
 Recipiente Retangular Alto para Alimentos



ref.	L (cm)	W (cm)	H (cm)	Lts	☐	Bar Code
754709A	18	13	9,70	0,95	4/16	8411922459531

Táper Alto Cuadrado

Tall Square Food Container
 Conteneur Alimentaire Carrés Haut
 Hoher Quadratischer Lebensmittelbehälter
 Recipiente Quadrado Ato para Alimentos



ref.	L (cm)	W (cm)	H (cm)	Lts	☐	Bar Code
754810A	16	16	9,50	1	4/16	8411922459548

Táper Alto Redondo

Tall Round Food container
 Conteneur Alimentaire Rond Haut
 Hoher Runder Lebensmittelbehälter
 Recipiente Redondo Alto para Alimentos



ref.	∅ (cm)	H (cm)	Lts	☐	Bar Code
755108A	16	9,80	0,80	4/16	8411922459555

Táper Rectangular Mini

Mini Rectangular Food Container
 Conteneur Alimentaire Rectangulaire Mini
 Mini Rechteckiger Lebensmittelbehälter
 Recipiente Retangular para Alimentos Mini



ref.	L (cm)	W (cm)	H (cm)	Lts	☐	Bar Code
754701	10	7	5	0,16	12/36	8411922452846

Táper Redondo Mini

Mini Round Food Container
 Conteneur Alimentaire Rond Mini
 Mini Runder Lebensmittelbehälter
 Mini recipiente redondo para alimentos



ref.	∅ (cm)	H (cm)	Lts	☐	Bar Code
755101	8	5,50	0,13	12/36	8411922452853

Táper 2 Compartimentos

Food Container with Two Sections
Conteneur Alimentaire avec 2 Compartiments
Lebensmittelbehälter mit 2 Fächern
Recipiente para Alimentos com 2 Compartimentos



ref.	L (cm)	W (cm)	H (cm)	Lts	📦	Bar Code
754110	17,50	12,70	6	0,60	4/24	8411922457995
754120	20	15	6,90	0,95	4/12	8411922458008

Set 3 Tapers Rectangulares

Set 3 Rectangular Food Containers
Jeu 3 Conteneurs Alimentaires Rectangulaires
Set 3 Rechteckige Lebensmittelbehälter
Jogo 3 Recipientes Rectangulares para Alimentos



ref.	Lts	📦	Bar Code
754750	0,18+0,65+1,5	6	8411922455878

Set 3 Tapers Redondos

Set 3 Round Food Containers
Jeu 3 Conteneurs Alimentaires Rondes
Set 3 Runder Lebensmittelbehälter
Jogo 3 Recipientes Redondos para Alimentos

ref.	∅ (cm)	H (cm)	Lts	📦	Bar Code
755150	11,6+15,8+20,5	5,6+7,1+8,2	0,220+0,650+1,300	6	8411922458367



Táper para Sopa XL

Soup Bowl XL
Récipient pour Soupe XL
Suppenbehälter XL
Recipiente para Sopa XL

ref.	L (cm)	W (cm)	H (cm)	Lts	📦	Bar Code
754833	19,50	19,50	11	3	2/8	8411922474466



Táper Rectangular Air Vent

Air Vent Rectangular Food Container
Conteneur Alimentaire Rectangulaire Air Vent
Rechteckiger Lebensmittelbehälter Air Vent
Recipiente Rectangular para Alimentos Air Vent



ref.	L (cm)	W (cm)	H (cm)	Lts	📦	Bar Code
757004	15,30	11,10	5,80	0,37	4/24	8411922452150
757006	17,60	13,10	6,50	0,65	4/24	8411922452167
757010	20,50	15,40	7,20	1	4/12	8411922452174
757015	22	16,40	6,60	1,50	4/12	8411922452181

Táper Cuadrado Air Vent

Air Vent Square Borosilicate Container
Conteneur Alimentaire Carré Air Vent
Quadratischer Lebensmittelbehälter Air Vent
Recipiente Cuadrado para Alimentos Air Vent



ref.	L (cm)	W (cm)	H (cm)	Lts	📦	Bar Code
757203	11,90	11,90	6,10	0,32	4/24	8411922452198
757205	13,70	13,70	6,80	0,52	4/24	8411922452204
757208	15,80	15,80	7,40	0,80	4/12	8411922452211
757212	18,50	18,50	7,50	1,20	4/12	8411922452228

Set 4 Tapers Redondos Eco

Set 4 Round Food Containers Eco
Set 4 Ronde Conteneurs pour Aliments Eco
Set 4 Runden Lebensmittelbehältern Eco
Set 4 Recipientes Redondos para Alimentos Eco



ref.	ml	∅ (cm)	📦	Bar Code
689200	236+472+944+1652	18	1/6	8411922470796

Set 3 Tapers Cuadrados Eco

Set 3 Square Food Containers Eco
Set 3 Carré Conteneurs pour Aliments Eco
Set 3 Quadratischen Lebensmittelbehältern Eco
Set 3 Recipientes Cuadrados para Alimentos Eco



ref.	ml	L (cm)	W (cm)	📦	Bar Code
689210	610+1170+1940	20	20	1/6	8411922470802

Táper de Borosilicato con Tapa de Bambú

Borosilicate Food Container with Bamboo Lid
 Borosilicate Récipient avec Couvercle en Bambou
 Borosilikat Lebensmittelbehälter mit Bambusdeckel
 Recipiente Borosilicato com Tapa de Bambú



ref.	L (cm)	W (cm)	H (cm)	Lts	📦	Bar Code
685206	17,10	12,60	5,70	0,65	4/24	8411922458152
685210	19,90	15	6,40	1	4/12	8411922458169
685215	21,70	16,20	7,10	1,50	4/12	8411922458176

Conservación.

Tritan.



Táper 200ml

Container 200ml
 Conteneur 200ml
 Tritan-Behälter 200ml
 Recipiente 200ml



ref.	L (cm)	W (cm)	H (cm)	📦	Bar Code
790402	11	8,50	5	4/72	8411922447996

Táper 600ml

Container 600ml
 Conteneur 600ml
 Tritan-Behälter 600ml
 Recipiente 600ml



ref.	L (cm)	W (cm)	H (cm)	📦	Bar Code
790406	16	12	6,50	4/24	8411922440393

Táper 800ml

Container 800ml
 Conteneur 800ml
 Tritan-Behälter 800ml
 Recipiente 800ml



ref.	L (cm)	W (cm)	H (cm)	📦	Bar Code
790408	15,50	15,50	7	4/24	8411922447002

Táper 1000ml

Container 1000ml
 Conteneur 1000ml
 Tritan-Behälter 1000ml
 Recipiente 1000ml



ref.	L (cm)	W (cm)	H (cm)	📦	Bar Code
790410	16	12	11	4/16	8411922440409

Táper 1200ml

Container 1200ml
 Conteneur 1200ml
 Tritan-Behälter 1200ml
 Recipiente 1200ml



ref.	L (cm)	W (cm)	H (cm)	📦	Bar Code
790412	23	16	6,50	4/16	8411922440416

Táper 1500ml

Container 1500ml
 Conteneur 1500ml
 Tritan-Behälter 1500ml
 Recipiente 1500ml



ref.	L (cm)	W (cm)	H (cm)	📦	Bar Code
790415	15,50	15,50	10,50	4/16	8411922447019

Táper 2000ml

Container 2000ml
 Conteneur 2000ml
 Tritan-Behälter 2000ml
 Recipiente 2000ml



ref.	L (cm)	W (cm)	H (cm)	📦	Bar Code
790420	27	20	6,50	4/8	8411922440423

Táper 2300ml

Container 2300ml
 Conteneur 2300ml
 Tritan-Behälter 2300ml
 Recipiente 2300ml



ref.	L (cm)	W (cm)	H (cm)	📦	Bar Code
790423	23	16	11	4/8	8411922440430

Táper 3200ml

Container 3200ml
 Conteneur 3200ml
 Tritan-Behälter 3200ml
 Recipiente 3200ml



ref.	L (cm)	W (cm)	H (cm)	📦	Bar Code
790432	27	20	11	4/8	8411922440447



Porta-Alimentos Lunch Away + 2 Tapers

Lunch Away Food Carrier + 2 Containers
 Porte-Aliments Lunch Away + 2 Conteneurs
 Lunch-Tasche Lunch Away + 2 Lebensmittelbehälter
 Porta-Alimentos Lunch Away + 2 Recipientes



- Poliéster
- Plástico
- Separador de espacio para fruta, bebida o lácteos
- Interior forrado con aislante térmico · 2 Bolsillos
- Bandolera desmontable
- Polyester
- Plastic
- Space divider for fruit, drinks or dairy products
- Interior lined with thermal insulation · 2 pockets
- Detachable strap



ref.	L (cm)	W (cm)	H (cm)	📦	Bar Code	
753450	21	12	22	1/6	8411922438765	GREEN
753455	21	12	22	1/6	8411922438772	PEACH

Porta-Alimentos Lite + Táper

Lite Food Carrier + Containers
 Porte-Aliments Lite + Conteneur
 Lunch-Tasche Lite + Lebensmittelbehälter
 Porta-Alimentos Lite + Recipiente



- Poliéster Lino
- Borosilicato
- Linen Polyester
- Borosilicate



ref.	L (cm)	W (cm)	H (cm)	Lts	📦	Bar Code	
753401A	21	13	14	3,75	1/6	8411922454567	AZUL
753401G	21	13	14	3,75	1/6	8411922454574	GRIS

Táper Lunch Away

Lunch Away Food Container
 Réipients Lunch Away
 Lebensmittelbehälter Lunch Away
 Recipiente para Alimentos Lunch Away

- Plástico
- Silicona
- Hermético
- Plastic
- Silicone
- Hermetic

0,60Lts

0,80Lts



0,60Lts
8 UDS.



0,80Lts
6 UDS.



ref.	L (cm)	W (cm)	H (cm)	Lts	📦	Bar Code	
753406G	19	10	5	0,60	8/16	8411922439335	VERDE/GREEN
753406P	19	10	5	0,60	8/48	8411922439359	MELOCOTÓN/PEACH
753408G	19	10	6,50	0,80	6/12	8411922439342	VERDE/GREEN
753408P	19	10	6,50	0,80	6/36	8411922439366	MELOCOTÓN/PEACH

Táper de Vidrio Lunch Away

Lunch Away Glass Container
Conteneur en Verre Lunch Away
Lunch Away Glasbehälter
Recipiente de Vidro Lunch Away



- **Borosilicato**
- Borosilicate

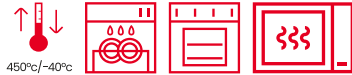

ref.	L (cm)	W (cm)	H (cm)	📦	Bar Code
753385	19	13	7	6/12	8411922441024

Set 3 Cubiertos con Estuche Lunch Away

Lunch Away Set 3 Cutlery with Cover
Jeu 3 Couverts avec Étui Lunch Away
Set 3 Teiliges mit Schachtel
Conjunto de 3 Talheres com Estojo



- **Acero Inoxidable 18%**
- Stainless Steel 18%



ref.	L (cm)	W (cm)	📦	Bar Code
700600	20	5	12/72	8411922449242

Dispensadores de Aliño

Condiment Dispensers
Distributeurs de Condiments
Gewürzspender
Dispensadores de Condimento



50ml

10ml

- **Vidrio**
- **Plástico**
- Glass
- Plastic



ref.	ml	📦	Bar Code
716250	10+50	6/36	8411922455304

Conservación.

Varios.

Fiambreira Térmica

Thermal Lunch Box
Boîte Alimentaire Thermique
Gedämmte Brotbüchse
Fiambreira Térmica

- **Plástico**
- **Doble pared**
- Plastic
- Double wall



ref.	∅ (cm)	Lts	H (cm)	📦	Bar Code
728914P	20	1,40	15	1/2/12	8411922441703
728914G	20	1,40	15	1/2/12	8411922441697
728922G	20	2,20	19	1/2/12	8411922441710



BLACK/PEACH
BLACK/GREEN
BLACK/GREEN

Portatortillas

Spanish Omelette Holder
Boîte à Tortilla
Tortilla-Halter
Porta-Tortilhas

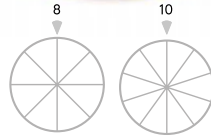
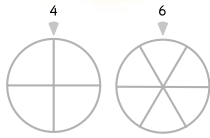

- Plástico
- Con marcadores de porciones
- Plastic
- Portion marking



ref.	∅ (cm)	∅	Bar Code	
749110	22	6/12	8411922440461	VERDE/GREEN
749100	26	6/12	8411922438512	MELOCOTÓN/PEACH

Set 3 Tapers Inox

Set 3 Stainless Steel Containers
Jeu 3 Conteneurs Inox
Set 3 Edelstahl Lebensmittelbehälter
Conjunto 3 Lancheiras Inox



- Acero Inoxidable
- Stainless Steel



ref.	∅ (cm)	Lts	∅	Bar Code
712000	14+16+18	0,75+1,2+1,5	6/24	8411922423389

Táper para Croquetas

Container for Storing croquettes
Boîte à Croquettes
Kroketten-Behälter
Recipiente para Croquetes



- Plástico
- Hermético
- Contenedor + 3 bandejas apilables
- Espacio para 45 unidades
- Plastic
- Hermetic
- Container + 3 stackable trays
- Space for 45 pieces



ref.	L (cm)	W (cm)	H (cm)	∅	Bar Code
686600	29	19	10,50	3/6	8411922459241

Táper para Queso

Cheese Container
Conteneur Fromage
Käse-Behälter
Recipiente para Queijo



- Plástico
- Plastic

ref.	L (cm)	W (cm)	H (cm)	∅	Bar Code
754510	27,50	22	6	14/84	8411922447101

Táper para Embutidos y Fiambres

Container for Deli Meats and Cold Cuts
Récipient pour Charcuterie
Behälter Für Wurstwaren/Fiambres Rot
Recipiente para Enchidos e Carnes Frias

• Plástico

• Plastic



ref.	L (cm)	W (cm)	H (cm)	📦	Bar Code
686700	24,80	14,40	3,30	12/24	8411922459470
686750	24,80	14,40	3,30	2/6	8411922476316
686710	24,80	14,40	3,30	6/36	8411922459500
686720	24,80	14,40	3,30	6/36	8411922459517
686730	24,80	14,40	3,30	6/36	8411922459524
686740	24,80	14,40	3,30	6/36	8411922476309



4x

4x

4x

(1) Surtido 12uds.
(1) Assorted 12pcs.



(2) Set 4uds.

(2) Set 4uds.



Porta Sandwich / Embutidos / Queso

Sandwich / Cold Meat / Cheese Box
Porte Sandwich / Charcuterie / Fromage
Box für Sandwich / Aufschnitt / Käse
Porta Sandúiches / Fumeiro / Queijo

• Plástico

• Plastic



ref.	L (cm)	W (cm)	H (cm)	📦	Bar Code
690400	14,50	14,50	3,60	12/48	8411922474350
690410	14,50	14,50	3,60	6/48	8411922474367
690420	14,50	14,50	3,60	6/48	8411922474374
690430	14,50	14,50	3,60	6/48	8411922474381
690440	14,50	14,50	3,60	6/48	8411922474398



3x

3x

3x

3x

Surtido 12uds.
Assorted 12pcs.



Guarda-Limones

Lemon Container
Boîte de Conservation Citrons
Zitronenhalter
Guarda-Limão



- Plástico
- Plastic



ref.	∅ (cm)	H (cm)	📦	Bar Code
782500E	9	11	6/24	8411922083736

Guarda-Tomates

Tomato Container
Boîte de Conservation Tomates
Tomatenhalter
Guarda-Tomates



- Plástico
- Plastic



ref.	∅ (cm)	H (cm)	📦	Bar Code
782501E	11	8	6/24	8411922083743

Guarda-Cebollas

Onion Container
Boîte de Conservation Oignons
Zwiebelhalter
Guarda-Cebollas



- Plástico
- Plastic



ref.	∅ (cm)	H (cm)	📦	Bar Code
782502E	11	12	6/24	8411922083750

Protector para Aguacate

Avocado Protector
Boîte de Conservation Avocats
Avocado-Schutz
Protetor de Abacate



- Plástico
- Plastic



ref.	∅ (cm)	H (cm)	📦	Bar Code
782505	10	12	6/24	8411922449778

Bote Hermético Square

Square Hermetic Container
Conteneur Hermétique Square
Luftdichtes Glas Square
Frasco Hermético Square



- Plástico
- Hermético
- Plastic
- Hermetic



ref.	L (cm)	W (cm)	H (cm)	Lts	📦	Bar Code
797105	9	9	10	0,50	6/24	8411922447170
797109	9	9	15	0,90	6/24	8411922447187
797112	9	9	20	1,20	6/24	8411922447194
797119	9	9	30	1,90	6/12	8411922447200

Tarro Borosilicato con Tapa de Bambú

Borosilicate Food Jar with Bamboo Lid
Borosilicate Récipient avec Couvercle en Bambou
Borosilikatglas mit Bambusdeckel
Jarro de Borosilicato con Tampa de Bambu



- Borosilicato
- Bambú
- Borosilicate
- Bamboo



ref.	Lts	L (cm)	W (cm)	H (cm)	📦	Bar Code
681008	0,80	11	11	11	6/24	8411922454437
681011	1,10	11	11	15	6/24	8411922454444
681015	1,50	11	11	19	6/24	8411922454451

Envase de Vacío Apilable Rectangular

Rectangular Stackable Vacuum Container
Récipient sous Vide Rectangulaire Empilable
Stapelbarer Rechteckiger Vakuumbehälter
Recipiente de Vácuo Empilhável Retangular

- Acero Inoxidable
- Plástico
- Hermético
- Stainless Steel
- Plastic
- Hermetic



ref.	L (cm)	W (cm)	H (cm)	ml	☐	Bar Code
788710	15,60	10,50	11,20	1000	1/6	8411922089608
788720	15,60	10,50	17,80	2000	1/6	8411922089615

Envase de Vacío Apilable Cuadrado

Square Stackable Vacuum Container
Récipient sous Vide Carré Empilable
Stapelbarer Quadratischer Vakuumbehälter
Recipiente de Vácuo Empilhável Quadrado

ref.	L (cm)	W (cm)	H (cm)	ml	☐	Bar Code
788605	10,50	10,50	11	500	1/6	8411922089578
788619	10,50	10,50	29	1950	1/6	8411922089592

Tarro Mini (Hexágono+Cuadrado)

Mini Jar (Hexagon + Square)
Pot Mini (Hexagone + Carré)
Mini-Glas (Sechseck + Quadrat)
Frasco Mini (Hexagono + Quadrado)

- Vidrio
- Glass

ref.	Lts	☐	Bar Code
739901	0,10	12/72	8411922434668



surtido / assorted 6A+6B=12

Tarro Mini (Redondo 45ml + 65ml)

Mini Jar (Round 45ml + 65ml)
Pot Mini (Rond 45ml + 65ml)
Mini-Glas (Rund 45ml + 65ml)
Frasco Mini (Redondo 45ml + 65ml)

- Vidrio
- Glass

ref.	Lts	☐	Bar Code
740000	0,045+0,065	12/72	8411922434675



surtido / assorted 6A+6B=12

Tarro de Cocina

Kitchen Jar
Pot de Cuisson
Glasbehälter
Jarro de Cozinha



- Vidrio
- Glass

ref.	Lts		Bar Code
742905	0,54	6/12	8411922435634
742908	0,80	6/12	8411922435641
742915	1,50	6/12	8411922435658

Tarro

Jar
Pot
Glas
Frasco



- Vidrio
- Glass

ref.	∅ (cm)	H (cm)	Lts		Bar Code
747210	10,80	15,50	0,65	6	8411922457919
747220	10,80	20	1	6	8411922457926
747230	10,80	23,50	1,25	6	8411922457933

Conservación.

Tin Box.

METÁLICO
METALLIC
MÉTALLIQUE
METALLIC
METÁLICO

Bote Galletero Antihumedad

Moisture Absorbing Biscuit Canister
Boîte à Biscuits Anti-Humidité
Keksdose Gegen Feuchtigkeit
Lata de Bolachas Antihumidade

ref.	∅ (cm)	H (cm)		Bar Code
812522	17	19,50	4	8411922448405
812523	17	19,50	4	8411922448412

ROMBOS/RHOMBUSES
RAYAS/LINES



Bote para Té

Tea Canister
Pot à Thé
Teedose
Lata para Chá

ref.	L (cm)	W (cm)	H (cm)		Bar Code
812500	7,60	7,60	10	6	8411922446562



surtido / assorted 2A+2B+2C=6

Bote con Asa White

White Canister with Handle
Pot avec Poignée White
Dose mit Henkel White
Lata com Asa White

ref.	∅ (cm)	H (cm)		Bar Code	
812503	11	16	6	8411922446593	CAFÉ/COFFEE
812504	11	16	6	8411922446609	AZÚCAR/SUGAR
812505	11	16	6	8411922446616	TÉ/TEA
812506	13,50	19	6	8411922446623	GALLETAS/BISCUITS



Bote con Cierre Black

Black Canister with Lock
Pot avec Fermature Black
Dose mit Verschluss Black
Lata com Fecho Black



ref.	L (cm)	W (cm)	H (cm)		Bar Code	
812507	12	8	19	4	8411922446630	CAFÉ/COFFEE
812508	12	8	19	4	8411922446647	AZÚCAR/SUGAR
812509	12	8	19	4	8411922446654	TÉ/TEA

Bote Cápsulas Café / Galletas

Coffee Capsules / Biscuits Canister
Pot à Capsules Café / Biscuits
Kaffeekapseln Kekse Dose
Lata para Cápsulas de Café / Bolachas



ref.	L (cm)	W (cm)	H (cm)		Bar Code	
812518	17	10	22	4	8411922446746	A
812519	14	8	19	6	8411922446753	B

Bote para Pasta

Pasta Canister
Pot à Pâtes
Nudeldose
Lata para Massa



ref.	Ø (cm)	H (cm)		Bar Code
812520	8,50	27	6	8411922446760



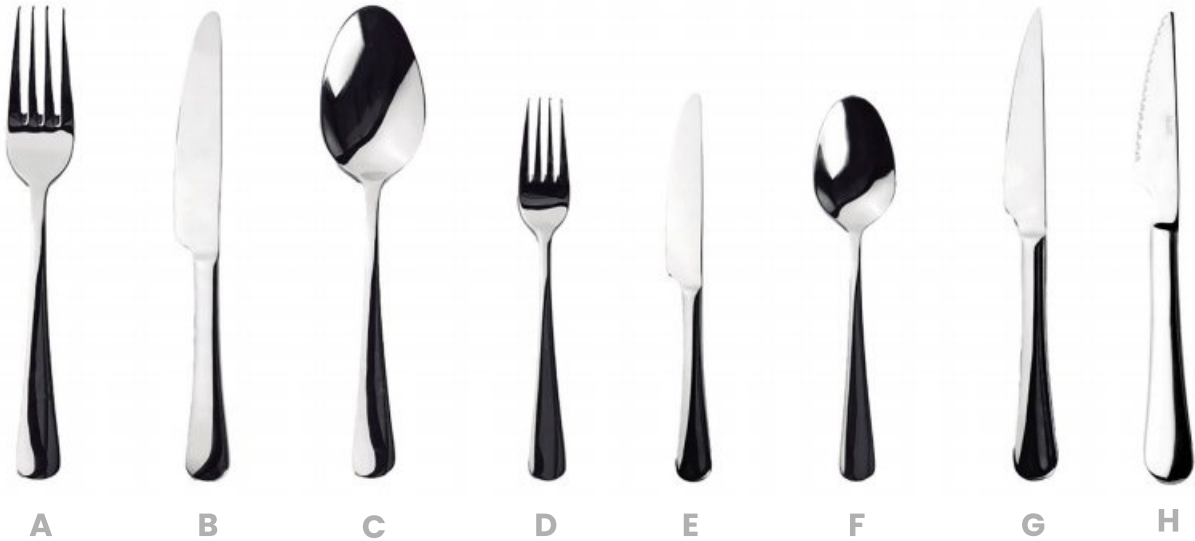

Set 3 Tenedores de Mesa A

Set 3 Table Forks
Jeu 3 Fourchettes De Table
Set 3 Tafelgabel
Set 3 Garfo de Mesa

ref.	L (cm)		Bar Code
680202	19,70	6/72	8411922449037

Set 3 Cuchillos de Mesa B

Set 3 Table Knives
Jeu 3 Couteaux De Table
Set 3 Tafelmesser
Set 3 Faca de Mesa

ref.	L (cm)		Bar Code
680200	23	6/36	8411922449013

Set 3 Cucharas de Mesa C

Set 3 Table Spoons
Jeu 3 Cuillères Table
Set 3 Tafelloffel
Set 3 Colher de Mesa

ref.	L (cm)		Bar Code
680201	20	6/72	8411922449020

Set 3 Tenedores de Postre D

Set 3 Dessert Forks
Jeu 3 Fourchettes à Dessert
Set 3 Dessetgabel
Set 3 Garfo de Sobremesa

ref.	L (cm)		Bar Code
680206	17,70	6/72	8411922449075

Set 3 Cuchillos de Postre E

Set 3 Dessert Knives
Jeu 3 Couteaux à Dessert
Set 3 Dessetmesser
Set 3 Faca de Sobremesa

ref.	L (cm)		Bar Code
680204	21	6/36	8411922449051

Set 3 Cucharas de Postre F

Set 3 Dessert Spoons
Jeu 3 Cuillères à Dessert
Set 3 Dessetloffel
Set 3 Colher de Sobremesa

ref.	L (cm)		Bar Code
680205	17,80	6/72	8411922449068

Set 3 Cuchillos de Carne G

Set 3 Steak Knives
Jeu 3 Couteaux à Viande
Set 3 Fleischmesser
Set 3 Faca para Carne

ref.	L (cm)		Bar Code
680207	21	6/36	8411922449082

Set 3 Cuchillos Chuleteros H

Set 3 Cutlet Knives
Jeu 3 Couteaux à Steak
3er-Set Filetmesser
Set 3 Facas para Carne

ref.	L (cm)		Bar Code
680210	22	6/36	8411922474336

Set 6 Tenedores Mini

Set 6 Mini Forks
Jeu 6 Fourchettes Mini
Set 6 Kleine Gabel
Set 6 Garfo Mini



ref.	L (cm)		Bar Code
680209	14,20	6/96	8411922449105

Set 6 Cucharillas de Café

Set 6 Coffee Spoons
Jeu 6 Cuillères à Café
Set 6 Kaffeelöffel
Set 6 Colher de Cafe

Set 6 Cucharillas Moka

Set 6 Moka Teaspoons
Jeu 6 Cuillère Moka
Set 6 Mokkalöffel
Set 6 Colher Moka

ref.	L (cm)		Bar Code
680208	14	6/96	8411922449099

ref.	L (cm)		Bar Code
680203	11	6/96	8411922449044

Juego 24 Cubiertos

Set 24 Knives And Forks
Jeu 24 Couverts
Besteckset 24 Teiling
Jogo 24 Talheres



X6

ref.	L (cm)	W (cm)		Bar Code
680250	25	18	1/6	8411922452006



Cuchillos y Tijeras.

ACERO INOXIDABLE

STAINLESS STEEL
ACIER INOXYDABLE
EDELSTAHL
AÇO INOX

Cuchillos y Tijeras.

Premium.

ACERO INOXIDABLE 420 MOV. POM
STAINLESS STEEL 420 MOV. POM
ACIER INOXYDABLE 420 MOV. POM
EDELSTAHL 420 MOV. POM
AÇO INOX 420 MOV. POM

- Mango resistente de polioximetileno (POM)
- Remaches de acero inoxidable
- Polyoxymethylene handles (POM)
- Stainless steel rivets



Cuchillo Mondador (A)

Paring Knife
Couteau d'Office
Schälmesser
Faca de Corte

ref.	L (cm)		Bar Code
797300	7,50	6/48	8411922433067

Cuchillo Cocina 130mm (C)

Kitchen Knife 130mm
Couteau Cuisine 130mm
Küchenmesser 130mm
Faca de Cozinha 130mm

ref.	L (cm)		Bar Code
797302	13	6/36	8411922433081

Cuchillo Verduras (B)

Vegetable Knife
Couteau à Légumes
Gemüsemesser
Faca de Legumes

ref.	L (cm)		Bar Code
797301	10	6/48	8411922433074

Cuchillo Cocina 150mm (D)

Kitchen Knife 150mm
Couteau Cuisine 150mm
Küchenmesser 150mm
Faca de Cozinha 150mm

ref.	L (cm)		Bar Code
797303	15	6/36	8411922433098

Cuchillo Cocinero 170mm E

Chef's Knife 170mm
Couteau Chef 170mm
Kochmesser 170mm
Faca de Cozinheiro 170mm

ref.	L (cm)		Bar Code
797304	17	6/36	8411922433104

Cuchillo Cocina 170mm F

Kitchen Knife 170mm
Couteau Cuisine 170mm
Küchenmesser 170mm
Faca de Cozinha 170mm

ref.	L (cm)		Bar Code
797305	17	6/36	8411922433111

Cuchillo Cocinero 200mm G

Chef's Knife 200mm
Couteau Chef 200mm
Kochmesser 200mm
Faca de Cozinheiro 200mm

ref.	L (cm)		Bar Code
797306	20	6/36	8411922433128

Cuchillo Jamonero H

Ham Knife
Couteau à Jambon
Schinkenmesser
Faca para Presunto

ref.	L (cm)		Bar Code
797310	25	6/36	8411922433135

Cuchillo Panero I

Bread Knife
Couteau à Pain
Brotmesser
Faca para Pão

ref.	L (cm)		Bar Code
797311	20	6/36	8411922433142

Cuchillo Santoku J

Santoku Knife
Couteau Santoku
Santoku-Messer
Faca Santoku

ref.	L (cm)		Bar Code
797312	17	6/36	8411922433159

Cuchillos y
Tijeras.

Cuchillos.

Cuchillo para Tomate

Tomato Knife
Couteau à Tomates
Tomatenmesser
Faca para Tomate



ref.	L (cm)		Bar Code
726200	22	24/48	8411922083545

Cuchillo para Pan

Knife For Bread
Couteau à Pain
Brotmesser
Faca para Pão



ref.	L (cm)		Bar Code
726210	26	15/30	8411922439953

Cuchillo de Cocina Multiuso Morado

Purple Multi-Purpose Kitchen Knife
 Couteau de Cuisine Multi-Usages Violet
 Lila Mehrzweck Küchenmesser
 Faca de Cozinha Multiusos Púrpura



ref.	L (cm)	📦	Bar Code
727608P	8,50	24/48	8411922088854
727612P	12,50	6/72	8411922088878

Cuchillo Multiuso con Funda

Multipurpose Knife with Sheath
 Couteau Multi-Usages avec Étui
 Mehrzweckmesser mit Scheide
 Faca Multiusos com Bainha



ref.	L (cm)	📦	Bar Code
797500	20	24/96	8411922439281

Cuchillo de Cocina Multiuso Verde

Green Multi-Purpose Kitchen Knife
 Couteau de Cuisine Multi-Usages Vert
 Grünes Mehrzweck Küchenmesser
 Faca de Cozinha Multiusos Verde



ref.	L (cm)	📦	Bar Code
727608	8,50	24/48	8411922084795
727612	12,50	6/72	8411922088861
727615	15	6/72	8411922088885
727650	8,5+12,5+15	6/36	8411922088908

Cuchillo Mondador Basic

Basic Paring Knife
 Couteau D'Office Basic
 Schälmesser Basic
 Faca para Descascar Basic



- **Acero Inoxidable 3Cr13**
- **Plástico**
- Stainless Steel 3Cr13
- Plastic



ref.	L (cm)	📦	Bar Code
680700	20	24/144	8411922454406

NEW

Cuchillo Dentado Colorful

Colorful Serrated Knife
 Couteau Dentelé Colorful
 Universalmesser Colorful
 Faca Serrilhada Colorful



- **Acero Inoxidable 3Cr13**
- **Plástico**
- Stainless Steel 3Cr13
- Plastic



ref.	L (cm)	📦	Bar Code
680750C	20	24/144	8411922475302

Cuchillo Mondador Basic Colorful

Basic Colorful Paring Knife
 Couteau D'Office Basic Colorful
 Schälmesser Basic Colorful
 Faca para Descascar Basic Colorful



- **Acero Inoxidable 3Cr13**
- **Plástico**
- Stainless Steel 3Cr13
- Plastic



ref.	L (cm)		Bar Code
680700C	20	24/144	8411922458749

Juego de 5 Cuchillos Colorful

Colorful 5 Knives Set
 Jeu 5 Couteaux Colorful
 5 Messern Set Colorful
 Jogo de 5 Facas Colorful



Juego de 5 Cuchillos Class

Class 5 Knives Set
 Jeu 5 Couteaux Class
 5 Messern Set Class
 Jogo de 5 Facas Class



- **Acero Inoxidable**
- **Plástico**
- **Bambú**
- Stainless Steel
- Plastic
- Bamboo

ref.	L (cm)	W (cm)	H (cm)		Bar Code
728320	14	10	34	1/4/8	8411922441680

Espátula para Mantequilla

Butter Spreader
 Spatule pour le Beurre
 Butterstreichmesser
 Espátula para Manteiga



- **Acero Inoxidable**
- **Plástico**
- Stainless Steel
- Plastic

ref.	L (cm)		Bar Code
628100	14,80	24/144	8411922470611

Set Cuchillos para Queso

Cheese Knife Set
 Jeu Couteaux à Fromage
 Käsemesserset
 Jogo de Facas para Queijo



- **Acero Inoxidable**
- **Madera**
- Stainless Steel
- Wood

ref.	∅ (cm)		Bar Code
782750	21	1/6/12	8411922440508



Tijeras de Cocina

Kitchen Scissors
Ciseaux de Cuisine
Küchenschere
Tesoura de Cozinha



ref.	L (cm)		Bar Code
704904	22	6/36	8411922081800

Tijeras para Aves

Poultry Scissors
Ciseaux à Volailles
Geflügelschere
Tesoura para Aves



ref.	L (cm)		Bar Code
704905	25	1/6/36	8411922083255

Tijeras para Hierbas

Herbs Scissors
Ciseaux à Herbes
Kräuterschere
Tesoura para Ervas



MULTI - HOJAS
MULTI - BLADES
MULTI - LAMES
MULTI - FOLHAS

ref.	L (cm)		Bar Code
704903	22	6/36	8411922081794

Tijeras Luxe

Luxe Scissors
Ciseaux Luxe
Schere Luxe
Tesoura Luxe



ref.	L (cm)		Bar Code
704909	23	6/36	8411922433760

Tijeras con Funda Magnética

Scissors with Magnetic Sheath
Ciseaux avec Gaine Magnétique
Schere mit Magnetischer Scheide
Tesoura com Bainha Magnética



- Magnético
- Magnetic

ref.	L (cm)		Bar Code
704911	22	6/36	8411922447149

Tijeras para Huevo de Codorniz

Quail Egg Scissors
Ciseaux à Oeuf de Caille
Wachteleier-Schere
Tesoura para Ovos de Codorniz



ref.	L (cm)	W (cm)		Bar Code
768200	14	6	6/12/144	8411922441062

Tijeras de Cocina (Surtido de Colores)

Kitchen Scissors (Assorted Colours)
Ciseaux de Cuisine (Assortiment de Couleurs)
Küchenschere (Farbsortiment)
Tesoura de Cozinha (Cores Sortidas)



ref.	L (cm)		Bar Code
704904C	22	24/48	8411922440584

Tijera Duo (Tabla + Cuchillo)

Duo Scissors (Board + Knife)
Ciseaux Duo (Planche + Couteau)
Schere Duo (Brett + Messer)
Tesoura Duo (Tábua + Faca)



- **Plástico**
- **Con cierre de seguridad**
- ***No disponible en EEUU**
- Plastic
- With safety lock
- *Not available in USA

ref.	L (cm)		Bar Code
704910	25	6/36	8411922440003

Tijeras Pelagambas

Prawn Peeling Scissors
Ciseaux Épluche-Crevettes
Meeresfrüchte Schere
Tesoura para Descascar Camarões



ref.	L (cm)		Bar Code
704906	18	6/120	8411922086850

Tijeras Multisuso

Multi-Purpose Scissors
Ciseaux Multifonctions
Mehrzweckschere
Tesoura Multiusos



ref.	L (cm)	W (cm)		Bar Code
705210	18,50	8	6/36	8411922441581

Tijeras para Trinchar Aves Profesional

Professional Poultry Carving Scissors
Ciseaux Professionnels pour Découper la Volaille
Professionelle Geflügelschere
Tesoura para Trinchar Aves Profissional



- **Con cierre de seguridad**
- With safety lock

ref.	L (cm)		Bar Code
704913	25,50	6/36	8411922448603

Tijeras para Huevo Hervido

Boiled Egg Scissors
Ciseaux à Oeuf Dur
Eierköpfer
Tesoura para Ovo Cozido



ref.	Ø (cm)		Bar Code
704912	8	6/36	8411922448306

Piedra para Afilor Combinada

Combined Sharpening Stone
Pierre à Aiguiser Combinée
Kombinierter Schärstein
Pedra para Afiar Combinada



- Corindón
- Corundum

ref.	L (cm)	W (cm)	H (cm)		Bar Code
688200	18	6	3,20	1/6/12	8411922470369

Afilador Compacto

Compact Sharpener
Aiguseur Compact
Kompaktes Messerschleifer
Afilador Compacto



- ABS
- 2 piedras (fina y gruesa) • Con ventosa
- ABS
- 2 stages (fine & coarse) • With suction cup

ref.	∅ (cm)	H (cm)		Bar Code
718210	6	6	6/48	8411922448924

Afilador Mini

Mini Sharpener
Aiguseur Mini
Mini Schärfer
Afiador Mini



ref.	L (cm)	W (cm)		Bar Code
796200	10	6	12/24	8411922093735

Afilador Plegable

Folding Sharpener
Aiguseur Pliant
Klappbarer Messerschärfer
Afiador de Facas Dobrável



- ABS
- ABS

ref.	L (cm)	W (cm)	H (cm)		Bar Code
783760	14	4	4,50	1/12/48	8411922448795

Afilador para Cuchillos de Cocina

Kitchen Knife Sharpener
Aiguseur de Couteaux de Cuisine
Küchenmesserschärfer
Afiador de Facas de Cozinha



- Piedra de cerámica y diamante
- Diamond and ceramic sharpener

ref.	L (cm)		Bar Code
783700	20	1/9/36	8411922083989

Afilador para Cuchillos y Tijeras

Knife and Scissors Sharpener
Aiguiseur de Couteaux et Ciseaux
Schärfer für Küchenmesser und Scheren
Afiador de Facas e Tesouras



ref.	L (cm)		Bar Code
783750	20	1/12/48	8411922435139

Afilador Profesional 7 Usos

Professional Knife Sharpener 7 Uses
Aiguiseur Professionnel 7 Utilisations
Professioneller Messerschärfer 7 Funktionen
Afiador Profissional 7 Tipos de Afiacao

- Acero Inoxidable
- ABS
- Stainless Steel
- ABS

1. RANURA GRUESA / COARSE SLOT - 2. RANURA MEDIA / MEDIUM SLOT - 3. RANURA FINA / FINE SLOT - 4. RANURA PARA CUCHILLOS DENTADOS / SERRATED KNIFE SLOT - 5. RANURA PARA CUCHILLOS DE CERÁMICA / CERAMIC KNIFE SLOT - 6. RANURAS PARA CUCHILLOS DE UN SOLO FILO / SINGLE - EDGED KNIFE SLOT - 7. AFILAR LAS TIJERAS / SHARPENING FOR SCISSORS



ref.	L (cm)	H (cm)		Bar Code
783770	23	9,50	1/6/36	8411922459838

Cuchillos y Tijeras.

Soportes.

Soporte Magnético para Cuchillos Inox

Stainless Steel Knife Magnetic Holder
Support Magnétique pour Couteaux Inox
Magnetischer Messerhalter aus Edelstahl
Suporte Magnético para Facas Inox

- Acero Inoxidable
- Magnético
- Stainless Steel
- Magnetic



ref.	L (cm)		Bar Code
748200	34	6/24	8411922437669

Soporte para Cuchillos y Tijeras

Support for Knives and Scissors
Support pour Couteaux et Ciseaux
Messer- und Scherenhalter
Suporte para Facas e Tesouras

- Plástico
- Poliestireno
- Plastic
- Polystyrene



ref.	H (cm)	Ø (cm)		Bar Code
799000	22	11	1/6	8411922434088

Soporte Magnético para Cuchillos Plástico

Plastic Knife Magnetic Holder
Support Magnétique pour Couteaux Plastique
Magnetische Messerleiste aus Plastik
Suporte Magnético de Plástico para Facas

- Magnético
- Plástico
- Magnetic
- Plastic



ref.	L (cm)		Bar Code
740438	38	6/36	8411922434811
740455	55	6/24	8411922434828

Peladores y Cortadores.

Peladores y Cortadores.

Cortadores.

PLÁSTICO. ACERO INOXIDABLE
PLASTIC. STAINLESS STEEL
PLASTIQUE. ACIER INOXYDABLE
KUNSTSTOFF. ROSTFREIER STAHL
PLÁSTICO. AÇO INOXIDÁVEL

Cortador para Ensaladilla Rusa

Olivier Salad Cutter
Coupe Salade Russe
Schneider für Russischen Salat
Cortador de Salada Russa



Zanahorias
Carrots



Pepinillos
Pickles



Patatas
Potatoes



Huevos
Eggs



Aceitunas
Olives



Queso
Cheese



- Plástico
- Metálico
- Para Laminas y Dados
- Para todo tipo de verduras cocidas
- Plastic
- Metallic
- Slices and Dice
- For all types of boiled vegetables



ref.	L (cm)	W (cm)	H (cm)		Bar Code
774710	21	12	3	1/6/24	8411922445077

Cortapatatas Profesional

Professional Potato Cutter
Coupe-Frites Professionnel
Pommesschneider Professionell
Cortador de Batatas Profissional

- Acero Inoxidable
- 2 medidas (9/12mm)
- Con ventosa
- Stainless Steel
- 2 sizes (9/12mm)
- With suction cup



ref.	L (cm)	W (cm)	H (cm)		Bar Code
721010	25,50	12,50	10	1/6/12	8411922448955

Cuchillas de Recambio para Cortapatatas Profesional

Replacement Blades for Professional Potato Cutter
Lames de Remplacement pour Coupe-Frites Professionnel
Ersatzklingen für Pommesschneider Professionell
Lâminas de Sutiuição para Cortador de Batatas Profissional

- Acero Inoxidable
- Stainless Steel



ref.	W (mm)		Bar Code
721010R	9	1/135	8411922458329
721011R	12	1/125	8411922458732

Cortador en Espiral Profesional

Spiral Slicer Professional
Coupe-Légumes en Spirale Professionnel
Spiralschneider Professionell
Cortador em Espiral Profissional



- Espiral o espagueti
- Con ventosa
- Spiral or spaghetti
- With suction cup

ref.	L (cm)	W (cm)	H (cm)		Bar Code
721110	26	8	11	1/6/12	8411922448962

Sacapuntas Triple

Triple Vegetable Sharpener
Taille-Légumes Triple
Dreifacher Bleistiftspitzer
Afia-Legumes Triple



ref.	L (cm)	∅ (cm)		Bar Code
745700	19	6,50	1/6/36	8411922436686

Sacapuntas para Verduras Grande

Large Vegetable Sharpener
Taille-Pointe Grande
Großer Gemüsespitzer
Apontador de Legumes Grande



ref.	∅ (cm)	H (cm)		Bar Code
723150	7	8	6/24	8411922093742

Sacapuntas para Verduras Pequeño

Small Vegetable Sharpener
Taille-Pointe Petite
Kleiner Gemüsespitzer
Apontador de Legumes Pequeno



ref.	L (cm)	H (cm)		Bar Code
723100	15,50	4	6/72	8411922080803

Cortador para Verduras

Vegetable Cutter
Coupe-Légumes
Gemüseschneider
Cortador de Legumes



- Para tiras y dados
- For strips and dice

ref.	L (cm)	W (cm)		Bar Code
741700	27	12	1/6	8411922435375

Cortapatatas Palanca Clásica

Clásica Lever Potato Cutter
Coupe-Frites à Levier Clásica
Hebel-Kartoffelschneider Clásica
Cortador de Batatas com Alavanca Clásica



ref.	L (cm)	W (cm)		Bar Code
739100	25	9	6/24	8411922093544

Cortapatatas Easycook

Easycook Potato Cutter
Coupe-Frites Easycook
Kartoffelschneider Easycook
Cortador de Batatas Easycook



ref.	L (cm)		Bar Code
777800	24	1/6/12	8411922080384

Molinillo Juliana

Julienne Grinder
Moulin à Julienne
Julienne-Mühle
Moedor Juliana



ref.	L (cm)		Bar Code
796400	25	1/6/18	8411922093766

Descorazonador para Pimientos

Pepper Corer
Vide-Poivrons
Pfeffer Entkerner
Descaroçador de Pimentos



- Nylon
- Nylon



ref.	∅ (cm)	H (cm)		Bar Code
745500	3-4	11	6/72	8411922436655

Cortador para Limones en Media Luna

Half Moon Lemon Cutter
Coupe-Citrons Demi-Lune
Halbmond-Zitronenschneider
Cortador de Limão Meia-Lua



- Profesional
- Profesional



ref.	L (cm)	H (cm)		Bar Code
746800	17	16	1/6/12	8411922437157

Cortapiñas First Class M

First Class Pineapple Cutter M
Coupe-Ananas First Class M
Ananasschneider First Class M
Cortador de Ananás First Class M



- **Pela y corta la piña en rodajas perfectas en unos segundos**
- Peel and cut pineapple into perfect slices in seconds

ref.	L (cm)	Ø (cm)	📦
784100	25	8,50	1/6/24

Cortapiñas First Class L

First Class Pineapple Cutter L
Coupe-Ananas First Class L
Ananasschneider First Class L
Cortador de Ananás First Class L



- **Pela y corta la piña en rodajas perfectas en unos segundos**
- Peel and cut pineapple into perfect slices in seconds

ref.	L (cm)	Ø (cm)	📦	Bar Code
784150	25	9,70	1/6/36	8411922434026

Cortapiñas Essential M

Essential Pineapple Cutter M
Coupe-Ananas Essential M
Ananasschneider Essential M
Cortador de Ananás Essential M



- **Pela y corta la piña en rodajas perfectas en unos segundos**
- Peel and cut pineapple into perfect slices in seconds

ref.	L (cm)	📦	Bar Code
784000	25	1/6/36	8411922084528

Cortador para Sandía Inox

Stainless Steel Watermelon Cutter
Coupe-Pastèque Inox
Wassermelonen Schneider aus Edelstahl
Cortador de Melancia Inox



- **Cortar y servir con un solo utensilio**
- Cut and serve in one tool



ref.	L (cm)	H (cm)	📦	Bar Code
746100	21,50	7	6/72	8411922436822

Cortador para Sandía Plástico

Plastic Watermelon Cutter
Coupe-Pastèque Plastique
Wassermelonen Schneider aus Plastik
Cortador de Melancia Plástico



- **Cortar y servir con un solo utensilio**
- Cut and serve in one tool

ref.	L (cm)	📦	Bar Code
749800	22	6/72	8411922438956

Descorazonador para Manzanas

Apple Corer
Vide-Pomme
Apfelentkerner
Descaroçador de Maçãs



ref.	L (cm)	Ø (cm)	📦	Bar Code
682600	19,50	2,80	6/72	8411922455960

Cortador para Manzanas Luxe

Luxe Apple Cutter
Luxe Coupe-Pommes
Apfelausstecher Luxe
Cortador de Maçãs Luxe



ref.	∅ (cm)	L (cm)	📦	Bar Code
782912	9	19	6/24	8411922083200

Cortador para Melón y Piña

Melon and Pineapple Cutter
Coupe-Melon et Ananas
Melonen- und Ananasschneider
Cortador de Melão e Ananás



ref.	L (cm)	📦	Bar Code
777300	22	1/6/12	8411922080216

Deshuesador para Mango

Mango Stoner
Dénoyauter Mangue
Mango Entkerner
Descaroçador de Manga



ref.	L (cm)	∅ (cm)	📦	Bar Code
744200	18,50	9	6/24	8411922436280

Deshuesador para Cerezas / Laminador para Fresas

Cherry Pitter / Strawberry Slicer
Dénoyauter Cerises / Coupe-Fraises
Kirschkentkerner / Erdbeeren Schneider
Descaroçador de Cerejas / Laminador para Morangos



ref.	∅ (cm)	H (cm)	📦	Bar Code
793300	8	16,50	1/6/24	8411922092486

Deshuesador para Cerezas y Aceitunas

Cherry and Olive Pitter
Dénoyauter Cerises et Olives
Entsteiner Für Kirschen Und Oliven
Descaroçador para Cerejas e Azeitonas



- Aleación de Zinc
- Zinc Alloy

ref.	L (cm)	📦	Bar Code
686300	18,50	6/48	8411922459210

Vaciador de Melón Doble

Double Melon Baller
Vide-Melon Double
Doppelseitige Melonenausstecher
Esvaziador de Melões Duplo



ref.	∅ (cm)	📦	Bar Code
741600	2,5/3	6/144	8411922435382

Deshuesador para Cerezas

Cherry Pitter
Dénoyauter Cerises
Kirschkentkerner
Descaroçador de Cerejas



ref.	📦	Bar Code
774100	1/6	8411922079463

Cortador para Foie

Foie Gras Cutter
Coupe-Foie Gras
Gänseleber Schneider
Cortador para Foie



ref.	L (cm)	W (cm)		Bar Code
719600	21	13	1/6/24	8411922079791

Lira para Queso

Cheese Lyre
Lyre à Fromage
Käseschneider
Lira de Queijo



ref.	L (cm)		Bar Code
724912	12	6/36	8411922082142
724917	17	6/36	8411922082159

Cortador para Queso en Barra 2 Espesores

Two Thickness Cheese Slicer
Coupe-Fromage 2 Épaisseurs
Käseschneider Mit 2 Schnittstärken
Cortador de Queijo 2 Espessuras



ref.	L (cm)		Bar Code
685700	23	6/144	8411922458855

Guía Cortacebollas

Onion Holder Slicer
Pique Découpe-Oignons
Zwiebelhalter/Schneidhilfe
Guia Cortacebollas



ref.	L (cm)		Bar Code
724200	13	6/120	8411922082074

Lira Cortaqueso Blando

Soft Cheese Lyre
Lyre à Fromage Doux
Weichkäseschneider
Cortador de Queijo Macio

- Aleación de Zinc
- Regulable
- Zinc Alloy
- Adjustable



ref.	L (cm)		Bar Code
744900	9,50	6/48	8411922436501

Hilo para Lira Cortaquesos (10 uds.)

Cheese Lyre Wire
Fil pour Lyre à Fromage
Ersatz Draht für Käseschneider
Fio para Lira de Queijo



ref.	L (cm)		Bar Code
725012	12	1/500	8411922082166
725017	17	1/1000	8411922082173

Cortador Ondulado

Wavy Cutter
Coupeur Ondulé
Wellenkutter
Cortador Ondulado



ref.	L (cm)	H (cm)		Bar Code
729900	8	10	6/180	8411922086140

Protector para Dedos

Finger Guard
Protecteur de Doigts
Fingerschützer
Protetor de Dedos



ref.	L (cm)	W (cm)		Bar Code
787900	6,50	6	6/144	8411922088090

Gafas para Cortar Cebolla

Onion Cutting Goggles
Lunettes pour Couper Oignons
Zwiebelgläser
Órculos para Cortar Cebollas



ref.		Bar Code
796600	6/60	8411922093827

Decorador Guirnalda Profesional

Professional Garland Decorator
Décorateur Guirlande Professionnel
Professioneller Dekorateur Girlande
Decorador Grinalda Profissional



- 2 medidas · Zanahoria y calabacín
- 2 sizes · Carrot & zucchini

ref.	L (cm)		Bar Code
779750	17	6/240	8411922457827

Decorador Espiral Doble

Double Spiral Decorator
Décorateur Spirale Double
Doppelspirale Dekorateur
Decorador de Espiral Dupla



ref.	L (cm)		Bar Code
779200	16	6/144	8411922081855

Cortahuevos Plástico

Plastic Egg Slicer
Coupe-Oeuf Plastique
Plastik-Eierschneider
Cortador de Ovos de Plástico



ref.	L (cm)	W (cm)		Bar Code
790500	14	8	6/72	8411922090529

Cortahuevos Inox

Stainless Steel Egg Slicer
Coupe-Oeuf Inox
Eierschneider aus Edelstahl
Cortador de Ovos Inox



- Acero Inoxidable 18/10
- Stainless Steel 18/10

ref.	L (cm)	W (cm)		Bar Code
769800	14,50	8,50	12/96	8411922161328

Perforador de Huevos

Egg Piercer
Perceur D'Oeufs
Eierstecher
Perfurador de Ovos



- Evita que se agriete en la cocción y ayuda a pelarlo
- Prevent from cracking during boiling and makes the egg easier to peel

ref.	Ø (cm)	H (cm)		Bar Code
687800	6	2,50	6/144	8411922460117

Pala Recogeverduras

Vegetable Scoop
Pelle à Légumes
Gemüseschaufel
Pá Recolhedora de Verduras



ref.	L (cm)	W (cm)		Bar Code
722224	24	15	1/6/24	8411922080087

Laminador para Ajos

Garlic Slicer
 Laminoir pour Ails
 Knoblauchhobel
 Laminador para Alhos



ref.	L (cm)	W (cm)	H (cm)	📦	Bar Code
730210	23	6	4,50	6/96	8411922448177

Cortador / Laminador de Huevos y Champiñones

Cutter / Slicer for Eggs & Mushrooms
 Couper pour Oeufs et Champignons
 Eier- und Pilzschneider
 Cortador / Laminador de Ovos e Cogumelos



ref.	∅ (cm)	L (cm)	📦	Bar Code
763450	6	11	6/48	8411922456332

Laminador para Aguacate

Avocado Slicer
 Coupe-Avocat
 Avocado-Aufschnittmaschine
 Laminador de Abacate



ref.	L (cm)	📦	Bar Code
751610	24,50	6/96	8411922445053



Mandolina Easycook

Easycook Mandolin
 Mandoline Easycook
 Mandoline Easycook
 Mandolina Easycook

5 CUCHILLAS
 5 BLADES



ref.	L (cm)	📦	Bar Code
772400	30	1/6/12	8411922077568



Mandolina en V

V-Shaped Mandolin
Mandoline en V
V-Mandoline
Mandolina em V



- **Plástico**
- **Acero Inoxidable**
- Plastic
- Stainless Steel



ref.	L (cm)		Bar Code
782000	31	1/6/12	8411922082814

NEW

Mandolina Vertical

Vertical Mandoline
Mandoline Verticale
Vertikale Mandoline
Mandolina Vertical

- **Acero Inoxidable**
- **Plástico**
- **Recipiente con tapa**
- **3 Cuchillas (1 lisa, 2 juliana)**
- Stainless Steel
- Plastic
- Container with lid included
- 3 Blades (1 stright, 2 julienne)



ref.	L (cm)	W (cm)	H (cm)		Bar Code
691400	17,20	11,30	5,20	1/6/12	8411922475746

NEW

Mandolina Regulable Class

Class Adjustable Mandoline
Mandoline Réglable Class
Verstellbare Mandoline Class
Mandolina Ajustável Class

- **Acero Inoxidable**
- **Plástico**
- **4 Cuchillas (1 lisa, 1 juliana, 2 ralladores)**
- Stainless Steel
- Plastic
- 4 Blades (1 straight, 1 julienne, 2 graters)



ref.	L (cm)	W (cm)	H (cm)		Bar Code
667000	35	12	8,30	1/6	8411922475319

Mandolina Regulable con Mango

Adjustable Mandolin with Handle
Mandoline Réglable avec Manche
Verstellbare Mandoline mit Handgriff
Mandolina Ajustável com Cabo



- **Regulable**
- Adjustable

ref.	L (cm)		Bar Code
789800	32	1/6/24	8411922090345

Pelador para Espárragos

Asparagus Peeler
 Éplucheur d'Asperges
 Spargelschäler
 Descascador de Espargos



- Professional
- Professional



ref.	L (cm)	📦	Bar Code
753500R	25	6/48	8411922439205

Cortador/Pelador para Judías Verdes

French Style Bean Slicer
 Effileur pour Haricots
 Grüner Bohnenschneider
 Cortador/Descascador de Feijão Verde



Pelador 3 Cuchillas

3-Blade Peeler
 Éplucheur à 3 Lames
 3-Klingen-Schäler
 Descascador 3 Láminas



ref.	L (cm)	📦	Bar Code
799700	13	12/360	8411922434538

ref.	L (cm)	📦
728600	18,50	12/48

Pelamanzanas

Apple Peeler
 Éplucheur de Pommes
 Apfelschäler
 Descascador de Maçãs



Pelador para Manzana y Kiwi

Apple and Kiwi Peeler
 Éplucheur de Pomme et Kiwi
 Apfel- und Kiwischäler
 Descascador de Maçãs e Kiwis



ref.	L (cm)	📦	Bar Code
725300	33	1/6/12	8411922082210

ref.	L (cm)	W (cm)	📦	Bar Code
793900	15	7	1/6/24	8411922093452

Pelador para Ajos

Garlic Peeler
Éplucheur à Ails
Knoblauch-Schäler
Descascador de Alho



- Silicona
- Silicone

ref.	L (cm)	W (cm)	📦	Bar Code
726800	7	5	12/96	8411922083682

Pela Ajos Eco

Eco Garlic Peeler
Éplucheur à Ail Eco
Knoblauchschäler Eco
Descascador de Alho Eco



- Silicona
- Silicone

ref.	L (cm)	📦	Bar Code
707900	14	12/120	8411922074918

Pelapatatas

Potato Peeler
Éplucheur de Pommes de Terre
Kartoffelschäler
Descascador de Batatas



ref.	L (cm)	📦	Bar Code
749000	11	30/120	8411922438529

Pelatatas Y

Y-Shaped Potato Peeler
Éplucheur de Pommes de Terres Y
Kartoffelschäler Y
Descascador de Batatas Y



ref.	L (cm)	W (cm)	📦	Bar Code
791400	15	7	24/96	8411922090833

Pelatomates

Tomato Peeler
Éplucheur de Tomates
Tomatenschäler
Pelatomates



ref.	L (cm)	W (cm)	📦	Bar Code
749050	11	5	30/120	8411922452730

Pelatomates Y

Tomato Peeler Y
Éplucheur de Tomates Y
Tomatenschäler Y
Pelatomates Y



ref.	L (cm)	W (cm)	📦	Bar Code
794000	15	7	24/96	8411922093445

Pelapatatas Confort

Confort Potato Peeler
Éplucheur à Legumes Confort
Kartoffelschäler Confort
Descascador de Batatas Confort



ref.	L (cm)	📦	Bar Code
739001	15	12/48	8411922093490

Set 3 Peladores

Set of 3 Peelers
Jeu de 3 éplucheurs
3-Teiliges Schälmesser-Set
Jogo 3 Descascadores



ref.	L (cm)		Bar Code
686200	13	6/60	8411922459203

Pelapatatas / Escamador Recto Classic

Straight Potato Peeler / Scaler Classic
Éplucheur / Écailleur Droit Classic
Gerade Kartoffelschäler / Fischentschupper Classic
Descascador / Escamador Reto Classic



ref.	L (cm)		Bar Code
742800	17	24/48	8411922435573

Pelador Basic

Basic Peeler
Éplucheur Basic
Schäler Basic
Descascador Basic



ref.	L (cm)		Bar Code
680600	16	24/192	8411922454390

Raspador de Escamas

Scale Scraper
Râpe à Écailles
Fischentschupper
Raspador de Escamas



ref.	L (cm)	H (cm)		Bar Code
705610	26	2	6/48	8411922449563

Pelador para Castañas

Chestnut Peeler
Éplucheur de Châtaignes
Maronenschäler
Descascador de Castanhas



ref.	L (cm)		Bar Code
680000	17,50	6/12/48	8411922448580

Pelador para Naranja

Orange Peeler
Éplucheurs d'Oranges
Orangenschäler
Descascador de Laranja



ref.	L (cm)		Bar Code
731300	10	12/96	8411922086102

Pelador para Calabaza

Pumpkin Peeler
Éplucheur à Courge
Kürbisschäler
Descascador de Abóbora



ref.	L (cm)	W (cm)		Bar Code
749600	17	10	6/72	8411922438796

Set 4 Utensilios para Decorar Calabazas

Set 4 Pumpkin Decorating Utensils
Set 4 Ustensiles pour Decorre les Citrouille
4Er Werkzeugset zum Dekorieren Von Kürbis
Conjunto de 4 Utensilios para Decorar Abóboras



ref.		Bar Code
721700	6/48	8411922448931

Desgranador para Granadas

Pomegranate Deseeder
Égreneuse à Grenades
Granatapfel Entkerner
Descascador de Romã



- Plástico
- Plastic

ref.	Cms		Bar Code
797000	18	6/48	8411922094114

Cascanueces Luxe

Luxe Nutcracker
Casse-Noix Luxe
Nussknacker Boletus
Quebra-Nozes Luxe



- Metálico
- Metallic

ref.	L (cm)		Bar Code
726300	18,50	6/24	8411922083606

Cascanueces Classic

Classic Nutcracker
Casse-Noix Classic
Nussknacker Classic
Qubra Nozes Classic



- Metálico
- Metallic

ref.	L (cm)		Bar Code
738800	18	12/24	8411922093476

Cascanueces de Madera Boletus

Nutcracker Boletus
Casse-Noix Boletus
Nussknacker Boletus
Qubra Nozes Boletus



- Madera de Haya
- Beech Wood

ref.	Ø (cm)	H (cm)		Bar Code
682500	6	10	12/24	8411922455953



Picador Rápido Rotatory

Rotatory Chopper
 Hachoir Rotatory
 Schnellzerkleinerer Rotatory
 Picador Rápido Rotatory



- **Material de alta calidad**
- **3 cuchillas**
- **Base antideslizante**
- High quality material
- 3 blades
- Non-slip base

ref.	∅ (cm)	H (cm)	📦	Bar Code
750350	12,50	13	1/6/24	8411922452747

Picador para Carne

Meat Mincer
 Hachoir à Viande
 Fleischwolf
 Picador para Carne



- **Incluye Receta**
- **Incluye 2 discos y accesorio para embutidos**
- Includes Recipe
- With 2 grinders and sausage making accessory

ref.	W (cm)	H (cm)	📦	Bar Code
777150	11	25	1/6	8411922456226

Picador Mini Easycook

Easycook Mini Mincer
 Hachoir Mini Easycook
 Mini-Zerkleinerer Easycook
 Picador Mini Easycook



ref.	L (cm)	📦	Bar Code
772300	18	1/6/48	8411922077551

Picador Basic

Chopper
 Hachoir
 Zerkleinerer
 Picadora



ref.	∅ (cm)	H (cm)	📦	Bar Code
768910	8	23	1/6/48	8411922448115

Picador Confort

Confort Mincer
 Hachoir Confort
 Zerkleinerer Confort
 Picador Confort



- **Acero Inoxidable**
- **Plástico**
- **Silicona**
- Stainless Steel
- Plastic
- Silicone

ref.	H (cm)	∅ (cm)	📦	Bar Code
799510	23	8,70	1/6/12	8411922434323

Picador Eco

Eco Mincer
Hachoir Eco
Zerkleinerer Eco
Picador Eco



ref.	H (cm)	∅ (cm)		Bar Code
799600	23	10	1/6/12	8411922434330

Picador para Ajo Eco

Eco Garlic Mincer
Hachoir à Ails Eco
Knoblauchschneider Eco
Picador de Alho Eco



ref.	∅ (cm)		Bar Code
750000	7	6/24	8411922439090

Prensa Ajos

Garlic Press
Presse-Ails
Knoblauchpresse
Prensa de Alho



ref.	L (cm)	W (cm)	H (cm)		Bar Code
776400	19	4	6	1/6/24	8411922087765

Prensador para Ajos

Stainless Steel Garlic Press
Pressoir à Ail Inox
Knoblauchpresse Edestahl
Prensador para Alhos Inox



- Aleación de Zinc
- Zinc Alloy

ref.	L (cm)		Bar Code
686400	16	6/48	8411922459227

Prensador para Ajos Inox

Garlic Crusher
Presse Ail
Knoblauchpresse
Prensador de Alhos



ref.	L (cm)	H (cm)		Bar Code
681900	10	7	6/72	8411922455601

Picador para Perejil

Parsley Mill
Hachoir à Persil
Kräutermühle
Moinho de Picar Salsa



ref.	L (cm)	H (cm)		Bar Code
688100	19	6	6/24	8411922470352

Pinzas.

ACERO INOXIDABLE

STAINLESS STEEL
ACIER INOXYDABLE
ROSTFREIER STAHL
AÇO INOXIDÁVEL



Tenacilla Barbacoa

Barbecue Tong
Pince à Barbecue
Grillzange
Pinças para Churrasco



ref.	L (cm)		Bar Code
745439	34	12/72	8411922436624

Pinza para Hielo

Ice Tong
Pince à Glaçon
Eiszange
Pinça para Gelo



ref.	L (cm)		Bar Code
763600	18	12/144	8411922203080

Tenacilla Punta de Nylon

Nylon Tip Tong
Pince Pointe Nylon
Nylonzange
Pinça Ponta de Nylon



- Ideal para superficies antiadherentes
- Perfect for non-stick surfaces



ref.	L (cm)	H (cm)		Bar Code
791125	25	4	6/48	8411922090628
791130	30	4	6/48	8411922090635
791135	35	4	6/48	8411922090642

Tenacilla Estrecha

Narrow Tong
Pince Étroite
Schmale Zange
Pinças Estreitas



ref.	L (cm)		Bar Code
745325	25	12/96	8411922436600
745330	30	12/96	8411922436617
745335	35	12/60	8411922439748

Pinza para Espinas de Pescado

Fish Bone Tweezer
Pince à Désarêter
Fischgrätenpinzette
Pinça para Espinhas de Peixe



ref.	L (cm)	H (cm)	📦	Bar Code
736700	8,50	2,40	6/144	8411922091793

Pinza Nylon Prof

Prof Nylon Tongs
Pince Nylon Prof
Nylon Zange Prof
Pinça Nylon Prof



ref.	L (cm)	📦	Bar Code
741824	24	6/96	8411922435344
741830	30	6/72	8411922435351

Pinza Universal

Universal Tongs
Pince Universelle
Universal-Zange
Pinça Universal



ref.	L (cm)	📦	Bar Code
706900	24,50	12/72	8411922074802

Pinza Nylon Color

Nylon Tong Assortment
Assortiment de Pince Nylon
Nylonzangen Sortiment
Pinças de Nylon Sortido



ref.	L (cm)	📦	Bar Code
751123	23	20/40	8411922441857

Pinza para Ensalada

Salad Tongs
Pince Salade
Salatzange
Pinça para Salada



ref.	L (cm)	📦	Bar Code
716300	20	6/72	8411922073355

Pinza - Tijera Repostería

Pastry Scissor - Tongs
Pince - Ciseaux Pâtisserie
Gebäckzange - Schere
Pinça - Tesourapara para Pastelaria



ref.	L (cm)	📦	Bar Code
745100	18	6/120	8411922436525

Pinza Universal Redonda

Universal Round Tong
Pince Universelle Ronde
Universal-Rundzange
Pinça Universal Redonda



ref.	L (cm)	📦	Bar Code
761200	23,50	6/72	8411922621846

Pinza para Albóndigas

Meatball Tongs
Pinces pour Boulettes de Viande
Frikadellenzange
Pinça para Almondegas



ref.	Ø (cm)	📦	Bar Code
708534	3,40	6/120	8411922075373
708544	4,40	6/108	8411922075380

Pinza para Frituras

Frying Tongs
Pince à Friture
Frittierzange
Pinça para Fritos



ref.	L (cm)		Bar Code
723200	23	6/72	8411922080810

Pinza Pastelería

Pastry Tongs
Pince Pâtisserie
Gebäckzange
Pinça para Pastelaria



ref.		Bar Code
761400	12/144	8411922621860

Pinza para Hielo con Muelle

Ice Tong with Spring
Pince à Glace avec Ressort
Eisklemme mit Feder
Pinça para Gelo com Mola



ref.	L (cm)		Bar Code
732300	19	6/24	8411922086331

Pinza para Jamón

Ham Tongs
Pince à Jambon
Schinkenlange
Pinça para Presunto



ref.	L (cm)		Bar Code
748900	12	6/120	8411922438550

Pinza Repostería con Anillas

Pastry Tongs with Rings
Pince Pâtisserie avec Anneaux
Backzange mit Ringen
Pinça de Pastelaria com Anéis



ref.	L (cm)		Bar Code
744300	17	6/96	8411922436310

Pinza de Precisión

Precision Tongs
Pince de Précision
Präzisionszange
Pinça de Precisão



ref.	L (cm)		Bar Code
740800	17	6/144	8411922435092
740821	21	6/144	8411922438581
740830	30	6/72	8411922449006

Pinza Servicio con Muelle

Serving Tongs with Spring
Pince Service avec Ressort
Servierzange mit Feder
Pinça para Servir com Mola



ref.	L (cm)		Bar Code
745000	20	6/96	8411922436518

Pinza Perforada

Perforated Tongs
Pince Perforée
Perforierte Zange
Pinça Perfurada



ref.	L (cm)		Bar Code
716410	22	6/108	8411922451023

Pinza de Precisión Curva

Curved Precision Tongs
Pince de Précision Courbe
Gebogene Präzisionszange
Pinça de Precisão Curva



ref.	L (cm)		Bar Code
741016	16	6/144	8411922448986
741021	21	6/144	8411922448993

Pinza para Horno

Oven Tongs
Pince à Four
Ofenzange
Pinça para Forno



- **Acero Inoxidable 18/10**
- **Silicona**
- Stainless Steel 18/10
- Silicone



ref.	L (cm)		Bar Code
741900	19	6/72	8411922435337

Pinza para Tarros de Conserva

Preserving Jar Clamp
Pince à Bocaux
Zange Für Einmachgläser
Pinça para Frascos de Comservas



ref.	L (cm)	W (cm)		Bar Code
684400	22	8	6/48	8411922457421

Pinza para Platos Calientes

Clip for Hot Dishes
Pince pour Plats Chauds
Zange für Heiße Teller
Pinça para Pratos Quentes



- **Acero Inoxidable 18/10**
- **Silicona**
- Stainless Steel 18/10
- Silicone

ref.	L (cm)		Bar Code
763150	18	6/36	8411922456325

Pinza Punta Inox

Pointed Stainless Steel Tongs
Pince Pointe Inox
Spitzzange, Edelstahl
Pinça Ponta Inox



ref.	L (cm)		Bar Code
690524	24	6/96	8411922474435
690530	30	6/72	8411922474442



Molinillo Rallador

Grater Grinder
Moulin Râpe
Trommelreibe
Moinho Ralador



- **Acero Inoxidable**
- **Plástico**
- Stainless Steel
- Plastic

ref.	L (cm)		Bar Code
772600	18	1/6/36	8411922077582

Rallador Fino Easycook

Easycook Fine Grater
Râpe Fine Easycook
Fein Reibe Easycook
Ralador Fino Easycook



- **Con Deposito**
- With Deposit

ref.	L (cm)	W (cm)		Bar Code
779101	27	8	1/6/24	8411922081749

Rallador para Queso Giratorio

Rotary Cheese Grater
Râpe à Fromage Rotative
Rotierende Käseibe
Ralador de Queijo Giratorio



- **Plástico**
- **Acero Inoxidable**
- **También para chocolate**
- Plastic
- Stainless Steel
- Also for chocolate

ref.	L (cm)	W (cm)	H (cm)		Bar Code
739850	20	14	10	1/6/24	8411922439786

Rallador Gueso Easycook

Easycook Coarse Grater
Râpe Grossière Easycook
Grobe Reibe Easycook
Ralador Grosso Easycook



- **Con Deposito**
- With Deposit

ref.	L (cm)	W (cm)		Bar Code
779101	27	8	1/6/24	8411922081749

Rallador 4 Caras Mini

Mini 4-Sided Grater
Râpe 4 Faces Mini
Mini 4 Seite Reibe
Mini Ralador 4 Faces



ref.	H (cm)		Bar Code
705300	7	6/144	8411922072617

Rallador 4 Caras

4-Sided Grater
Râpe 4 Faces
Reibe 4 Seiten
Ralador 4 Lados



ref.	H (cm)		Bar Code
756600	20	6/84	8411922209259

Rallador 4 Caras XL

Grater 4 Sides XL
Râpe 4 Faces XL
4-Seitige Reibe XL
Ralador 4 Caras XL



ref.	L (cm)	W (cm)		Bar Code
682000	10,50	7,50	6/12	8411922455618

Rallador 4 Caras Mini Verde

Mini 4-Sided Grater Green
Râpe 4 Faces Mini Vert
Reibe 4 Seiten Mini Grün
Ralador 4 Lados Mini Verde



ref.	H (cm)		Bar Code
756650	7	6/72	8411922435184

Rallador Plano Inox

Stainless Steel Flat Grater
Râpe Plate Inox
Flache Reibe Edelstahl
Ralador Plano Inox



ref.	L (cm)	W (cm)		Bar Code
680900	28	11,50	6/60	8411922454420

Rallador Plano Basic

Basic Flat Grater
Râpe Plate Basic
Flache Reibe Basic
Ralador Plano Basic



ref.	L (cm)	W (cm)		Bar Code
681300	24	11	6/72	8411922455502

Rallador para Nuez Moscada

Nutmeg Grater
Râpe pour Noix de Muscade
Muskatnuss-Reibe
Ralador de Noz-Moscada



ref.	L (cm)		Bar Code
750600	13,50	6/144	8411922069952

Rallador para Berza

Cabbage Grater
Râpe à Chou
Kohlreibe
Ralador de Couve



ref.	L (cm)		Bar Code
748410	13	6/60	8411922441932

Rallador 3 Cuchillas

3 Blade Grater
Râpe 3 Lames
3-Klingen-Reibe
Ralador 3 Lâminas



- Acero Inoxidable
- Plástico
- Stainless Steel
- Plastic



ref.	L (cm)		Bar Code
772500	15	1/6/60	8411922077575

Rallador Class

Class Grater
Râpe Class
Reibe Class
Ralador Class



ref.	L (cm)		Bar Code
748400	32	6/60	8411922437690
748401	32	6/60	8411922437706

FINO
GRUESO

Rallador Largo Class

Class Long Grater
Râpe Longue Class
Langreibe Class
Ralador Longo Class



ref.	L (cm)		Bar Code
748450	40	6/60	8411922437713
748451	40	6/60	8411922437720

FINO
GRUESO

Laminador para Trufa / Chocolate

Truffle / Chocolate Grater
Râpe à Truffes / Chocolat
Trüffel- & Schokoladenreibe
Laminador para Trufa / Chocolate



- Hoja ajustable
- Adjustable blade

ref.	L (cm)	W (cm)		Bar Code
730100	18	9	6/72	8411922439779

NEW

Set 3 Ralladores Basic

Basic Set of 3 Graters
Set de 3 Râpes Basic
Set 3 Reiben Basic
Conjunto 3 Raladores Basic

- Acero Inoxidable
- Plástico
- Stainless Steel
- Plastic



ref.	L (cm)	W (cm)	H (cm)		Bar Code
666600	21	6,50	4	6/96	8411922475166

Molinillo Rallador para Queso

Cheese Grater Grinder
Râpe à Fromage à Manivelle
Käsereibe
Muinho Ralador para Queijo



ref.	L (cm)	W (cm)	H (cm)		Bar Code
690600	20	11	8,30	6/24	8411922474459

Tapas.

ACERO INOXIDABLE

STAINLESS STEEL
ACIER INOXYDABLE
ROSTFREIER STAHL
AÇO INOXIDÁVEL



- Pomo de Baquelita
- Bakelite Knob

Tapa Multiuso Profesional I-Chef

I-Chef Professional Multipurpose Lid
Couvercle Multi-Usages Professional I-Chef
Professioneller Mehrzweck-Deckel I-Chef
Tampa Multiuso Profesional I-Chef



ref.	∅ (cm)	📦	Bar Code
714319	14-16-18	6/108	8411922440010
714323	18-20-22	6/72	8411922440027
714327	22-24-26	6/36	8411922440034
714331	26-28-30	6/36	8411922440041
714337	30-32-34-36	6/36	8411922439687
714343	36-38-40-42	6/12	8411922439694

Tapa Multiuso con Agujeros

Multipurpose Lid with Holes
Couvercle Multi-Usages avec Trous
Mehrzweck-Deckel mit Löchern
Tampa Multiuso com Furos



ref.	∅ (cm)	📦	Bar Code
714219	14-16-18	6/60	8411922203943
714223	18-20-22	6/48	8411922203950
714227	22-24-26	6/36	8411922203967
714231	26-28-30	6/24	8411922203974
714237	30-32-34-36	6/24	8411922203981
714243	36-38-40-42	6/12	8411922203988

Tapa Volteatortillas

Omelette Flip Lid
Couvercle Retourne-Omelette
Tortilla-Wendedeckel
Tampa para Voltear Tortilhas



ref.	∅ (cm)	📦	Bar Code
715826	26	6/36	8411922068412
715830	30	6/24	8411922068429

Tapa Multiuso sin Agujeros

Multipurpose Lid without Holes
Couvercle Multi-Usages sans Trous
Mehrzweck-Deckel ohne Löchern
Tampa Multiuso sem Furos



ref.	∅ (cm)	📦	Bar Code
715719	14-16-18	6/60	8411922161700
715723	18-20-22	6/24	8411922161717
715727	22-24-26	6/36	8411922161724
715731	26-28-30	6/24	8411922161731
715737	30-32-34-36	6/24	8411922161748

Tapa de Cristal con Pomo Inox

Glass Cover with Stainless Steel Knob
Couvercle en Verre avec Poignée Inox
Glasdeckel mit Edelstahlknopf
Tampa de Vidro com Pegador Inox



- Pomo Acero Inoxidable
- Stainless Steel Knob

ref.	Ø (cm)	📦	Bar Code
971612	12	6/24	8411922457254
971616	16	6/24	8411922455397
971618	18	6/24	8411922455403
971620	20	6/12	8411922455410
971622	22	6/12	8411922455427
971624	24	6/12	8411922455434
971626	26	6/12	8411922455441
971628	28	6/12	8411922455458
971630	30	6/12	8411922455465
971632	32	6	8411922455472

Tapa de Cristal

Glass Cover
Couvercle en Verre
Glasdeckel
Tampa de Vidro



ref.	Ø (cm)	📦	Bar Code
970712	12	6/24	8411922457247
970714	14	6/24	8411922439991
970716	16	6/24	8411922161762
970718	18	6/24	8411922161779
970720	20	6/12	8411922161786
970722	22	6/12	8411922161793
970724	24	6/12	8411922161809
970726	26	6/12	8411922161816
970728	28	6/12	8411922161823
970730	30	6/12	8411922161830
970732	32	3/6	8411922161847
970736	36	3/6	8411922433265

Tapa de Cristal con Pomo Plegable

Glass Cover with Folding Knob
Couvercle en Verre avec Poignée Pliante
Glasdeckel mit Klappknopf
Tampa de Vidro com Pegador Dobrável



- Asa Abatible
- Folding Handle

ref.	Ø (cm)	📦	Bar Code
970914	14	6/24	8411922440096
970916	16	6/24	8411922440102
970918	18	6/24	8411922440119
970920	20	6/12	8411922440126
970922	22	6/12	8411922440133
970924	24	6/12	8411922440140
970926	26	6/12	8411922440157
970928	28	6/12	8411922440164
970930	30	6/12	8411922440171
970932	32	3/6	8411922440188

Tapa de Cristal con Borde de Silicona

Glass Cover with Silicone Rim
Couvercle en Verre avec Bord en Silicone
Glasdeckel mit Silikon-Deckelrand
Tampa de Vidro com Rebordo de Silicone



- Silicona
- Silicone

ref.	Ø (cm)	📦	Bar Code
970800	18+20+22	6/12	8411922433340
970805	16+18+20	6/12	8411922448535
970810	24+26+28	6/12	8411922433357
970815	28+30+32	6	8411922451542

NEW

Tapa Multiuso Cuadrada

Square Multiuse Lid
Couvercle Multiusage Carré
Quadratische Multifunktionsabdeckung
Tampa Multiuso Quadrada



- **Acero Inoxidable**
- Stainless Steel

ref.	L (cm)	W (mm)		Bar Code
667330	30	30	6/24	8411922475401

Tapa Antiderrame

Non-Spill Lid
Couvercle Anti-Éclaboussures
Überlaufschutz Deckel
Tampa Antiderrame



- **Silicona**
- **Evita el rebosamiento por ebullición**
- Silicone
- Stops over boiling

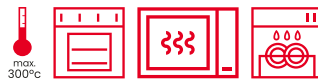

ref.	∅ (cm)		Bar Code
749727	29	1/5/25	8411922438802

Pomo Inox para Tapa de Cristal

Stainless Steel Knob for Glass Cover
Poignée Inox pour Couvercle en Verre
Edelstahlknopf für Glasdeckel
Pegador Inox para Tampa de Vidro



ref.		Bar Code
971600	6/72	8411922459609

Tapa de Malla Antisalpicaduras Eco

Eco Mesh Splatter Screen
Couvercle en Maille Anti-Éclaboussures Eco
Netz Spritzschutz Eco
Tampa de Rede Anti-Salpicos Eco



ref.	∅ (cm)		Bar Code
703625	25	6/36	8411922458237
703630	30	6/36	8411922458244

Tapa de Malla Antisalpicaduras Class

Class Mesh Splatter Screen
Couvercle en Maille Anti-Éclaboussures Class
Netz Spritzschutz Class
Tampa de Rede Anti-Salpicos Class



ref.	∅ (cm)		Bar Code
704329	29	6/36	8411922079623

Tapalimentos Malla

Protective Mesh Lid
Couvercle de Protection à Maille
Masche Lebensmittel Abdeckung
Tapa-Pratos de Rede



- **Acero Inoxidable 18/10**
- **Stainless Steel 18/10**

ref.	∅ (cm)		Bar Code
704129	29	6/72	8411922069877

Tapa para Plancha Grill

Cover for Grill
Couvercle pour Plancha
Deckel für Grillplatte
Tampa para Placa de Grelhar



- **Perfecta para fundir queso**
- **Perfect for melting cheese**

ref.	∅ (cm)	H (cm)		Bar Code
713900	23,20	7,50	6/24	8411922450019
713914	15,50	6	6/48	8411922459449

Tapa de Silicona Plegable

Foldable Silicone Lid
Couvercle en Silicone Pliant
Faltbarer Silikondeckel
Tampa de Silicone Dobrável



- **Silicona**
- **2 posiciones · Guardado fácil**
- **Silicone**
- **2 positions · Easy storage**



ref.	∅ (cm)	H (cm)		Bar Code
798500	25,50	8,50	6/24	8411922433968

Tapa de Cristal con Base de Madera

Glass Cover with Wooden Base
Couvercle en Verre avec Fond en Bois
Glasdeckel mit Holzuntersatz
Tampa de Vidro com Base de Madeira



- **Vidrio**
- **Bambú**
- **Elegante y totalmente transparente**
- **Glass**
- **Bamboo**
- **Elegant and completely transparent**

ref.	∅ (cm)		Bar Code	
715518	18	1/4	8411922455274	M
715520	20	1/4	8411922455281	L
715526	26	1/2	8411922455298	XL
715530	30	1/2	8411922458442	XXL



Tablas para Cortar.

Tabla para Pan de Madera

Wooden Bread Board
Planche à Pain en Bois
Holz Brotbrett
Tábua de Madeira para Pão



- **Bambú**
- Bamboo

ref.	L (cm)	W (cm)	H (cm)	📦	Bar Code
747340	38	25	2	6	8411922448481

NEW

Tabla para Corte con Tope

Cutting Board with Stopper
Planche à Découper avec Butée
Schneidebrett mit Anschlag
Tábua de Corte com Tope

- **Bambú**
- Bamboo

ref.	L (cm)	W (cm)	H (cm)	📦	Bar Code
691100	45	35	3,90	3/6	8411922475203

Tabla para Corte de Fibra de Madera

Fibreboard Cutting Board
Planche à Découper en Fibre de Bois
Schneidebrett aus Holzfaser
Tabua de Corte em Fibra de Madeira



ref.	L (cm)	W (cm)	H (cm)	📦	Bar Code
715429	29	19	6	4/32	8411922456868
715433	33	23	6	4/16	8411922456875
715437	37	27	6	4/16	8411922456882

Tabla para Corte de Bambú

Bamboo Cutting Board
Planche à Découper en Bambou
Schneidebrett aus Bambus
Tábua de Corte de Bambu



- **Bambú**
- **Reversible**
- Bamboo
- Reversible

ref.	L (cm)	W (cm)	H (cm)	📦	Bar Code
743028	28	20	1,50	6	8411922453584
743033	33	23	1,50	6	8411922453591
743040	39,50	28	1,50	6	8411922453607



- **Utilizable por ambos lados, un lado liso y el otro con canal**
- **Superficie de alta densidad que evita la absorción de líquidos**
- **Resistente a manchas o marcas de cuchillos**
- **Fibra de madera procedente de bosques gestionados de forma sostenible**
- Usable on both sides. One side is smooth and the other side has grooves
- The surface is high density so liquids aren't absorbed
- Resists knife marks and stains
- Environmentally friendly cutting board made with wood fibre and natural resin from sustainably managed forests

Tabla para Corte Blanca (Universal)

White Cutting Board (Universal)
Planche à Découper Blanche (Universelle)
Schneidebrett Weiß (Universal)
Tábua de Cortar Branca (Universal)



ref.	L (cm)	W (cm)	H (cm)		Bar Code
749430	30	20	1,50	4/12	8411922438376
749433	33	23	1,50	4/12	8411922438383
749438	38	28	1,50	4/8	8411922438390

Tabla para Corte Amarilla (Aves)

Yellow Cutting Board (Poultry)
Planche à Découper Jaune (Oiseaux)
Schneidebrett Gelb (Geflügel)
Tábua de Cortar Amarela (Aves)



ref.	L (cm)	W (cm)	H (cm)		Bar Code
749433Y	33	23	1,50	4/12	8411922438437

Tabla para Corte Azul (Pescado)

Blue Cutting Board (Fish)
Planche à Découper Bleue (Poisson)
Schneidebrett Blau (Fisch)
Tábua de Cortar Azul (Peixe)



ref.	L (cm)	W (cm)	H (cm)		Bar Code
749433A	33	23	1,50	4/12	8411922438406

Tabla para Corte Roja (Carne)

Red Cutting Board (Meat)
Planche à Découper Rouge (Viande)
Schneidebrett Rot (Fleisch)
Tábua de Cortar Vermelha (Carne)



ref.	L (cm)	W (cm)	H (cm)		Bar Code
749433R	33	23	1,50	4/12	8411922438420

Tabla para Corte Verde (Verduras)

Green Cutting Board (Vegetables)
Planche à Découper Verte (Légumes)
Schneidebrett Grün (Gemüse)
Tábua de Cortar Verde (Legumes)



ref.	L (cm)	W (cm)	H (cm)		Bar Code
749433V	33	23	1,50	4/12	8411922438413

Tabla para Corte (Surtido 8 Piezas)

Cutting Board (Assortment 8 pcs)
Planche à Découper (Assortiment 8 pcs)
Schneidebrett (Sortiment 8 Stück)
Tábua de Cortar (Sortido 8 Peças)

ref.	L (cm)	W (cm)	H (cm)		Bar Code
749400	33	23	1,50	8	8411922438444



X2

Termómetros.

ACERO INOXIDABLE
STAINLESS STEEL
ACIER INOXYDABLE
ROSTFREIER STAHL
AÇO INOXIDÁVEL



Termómetro para Horno

Oven Thermometer
Thermomètre pour Four
Backofen-Thermometer
Termómetro para Forno



max.250°C
480°F

ref.	L (cm)	W (cm)		Bar Code
743400	7	6	6/72	8411922435931

Termómetro Alimentos con Sonda

Food Thermometer with Probe
Thermomètre Aliments avec Sonde
Lebensmittelthermometer mit Fühler
Termómetro para Alimentos con Sonda



max.150°C
300°F

ref.	L (cm)		Bar Code
743401	14	6/72	8411922435948

Termómetro para Carne con Sonda

Meat Thermometer with Probe
Thermomètre Viande avec Sonde
Fleischthermometer mit Fühler
Termómetro para Carne com Sonda



• Para aceite

• For oil



max.150°C
300°F

ref.	L (cm)	Ø (cm)		Bar Code
743402	16	5	6/72	8411922435955

Termómetro Alimentos/Horno con Sonda

Food/Oven Thermometer with Probe
Thermomètre Aliments/Four avec Sonde
Lebensmittel-/Ofenthermometer mit Fühler
Termómetro para Alimentos/Forno com Sonda



max.250°C
480°F

ref.	L (cm)	Ø (cm)		Bar Code
743403	13	7	6/72	8411922435962

Termómetro Digital con Sonda

Digital Thermometer with Probe
Thermomètre Numérique avec Sonde
Digitalthermometer mit Fühler
Termómetro Digital com Sonda



ref.	L (cm)	⊠	Bar Code
743404	22	6/72	8411922435979

Termómetro Digital Magnético con Sonda

Magnetic Digital Thermometer with Probe
Thermomètre Numérique Magnétique avec Sonde
Magnetisches Digitalthermometer mit Fühler
Termómetro Digital Magnético com Sonda



- Longitud del cable: 115cm
- Cable length: 115cm

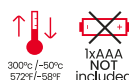

ref.	L (cm)	W (cm)	⊠	Bar Code
743405	7	6	6/72	8411922435986

Set 3 Termómetros para Horno con Sonda (Patata, Carne, Aves)

Set 3 Oven Thermometers with Probe (Potato, Meat, Poultry)
Jeu 3 Thermomètres pour Four avec Sonde (Pommes de Terre, Viande, Volaille)
Set 3 Backofenthermometer mit Fühler (Kartoffel, Fleisch, Geflügel)
Conjunto 3 Termómetros para Forno com Sonda (Batata, Carne, Aves)



ref.	L (cm)	∅ (cm)	⊠	Bar Code
743406	7	2,50	6/72	8411922436730

Termómetro Frigorífico - Congelador Digital

Digital Fridge - Freezer Thermometer
Thermomètre Réfrigérateur - Congélateur Numérique
Digitales Kühl- und Gefrierschrankthermometer
Termómetro Digital para Frigorífico - Congelador



- Plástico
- Plastic

ref.	L (cm)	W (cm)	⊠	Bar Code
743410	7	4,50	6/72	8411922448825

Termómetro Frigorífico - Congelador

Fridge - Freezer Thermometer
Thermomètre pour Réfrigérateur - Congélateur
Kühl- und Gefrierschrank-Thermometer
Termómetro para Frigorífico - Congelador



ref.	L (cm)	W (cm)	⊠	Bar Code
743409	7	7	6/72	8411922448818



Utensilios.

Utensilios.

Intense.

ACERO INOXIDABLE
STAINLESS STEEL
ACIER INOXYDABLE
ROSTFREIER STAHL
AÇO INOXIDÁVEL



Espumadera

Skimmer
Écumoire
Schaumlöffel
Escumadeira



ref.	L (cm)	Ø (cm)		Bar Code
762010	36	10	6/36	8411922447613

Espumadera de Malla

Mesh Skimmer
Écumoire en Maille
Netzschaumlöffel
Escumadeira de Malha



ref.	L (cm)	Ø (cm)		Bar Code
762011	36	11	6/36	8411922447620

Espumadera de Alambre

Wire Skimmer
Écumoire à Fil
Schaumlöffel aus Draht
Escumadeira de Arame



ref.	L (cm)	Ø (cm)		Bar Code
762025	36	12	6/36	8411922447767

Cacillo

Ladle
Louche
Schöpfkelle
Concha



ref.	L (cm)	Ø (cm)		Bar Code
762012	33	8	6/36	8411922447637

Espátula Paleta

Straight Spatula
Spatule Droite
Gerader Spatel
Espátula Reta



ref.	L (cm)	W (cm)		Bar Code
------	--------	--------	--	----------

762052	26,50	7,50	6/72	8411922459760
--------	-------	------	------	---------------

Espátula Silicona

Silicone Spatula
Spatule en Silicone
Silikon-Spatel
Espátula de Silicone



ref.	L (cm)	W (cm)		Bar Code
------	--------	--------	--	----------

762051	30,50	7,70	6/72	8411922459562
--------	-------	------	------	---------------

Prensa Ajos

Garlic Press
Presse-Ails
Knoblauchpresse
Prensa de Alho



ref.	L (cm)		Bar Code
------	--------	--	----------

762031	20	6/54	8411922447828
--------	----	------	---------------

Cacillo con Ecurridor

Ladle with Strainer
Louche avec Égouttoir
Schöpfkelle mit Abtropfsieb
Concha com Escorredor



ref.	L (cm)	Ø (cm)		Bar Code
------	--------	--------	--	----------

762048	31	8	6/36	8411922456240
--------	----	---	------	---------------

Mazo Tenderizador

Meat Tenderiser
Attendrisseur à Viande
Zartmacherhammer
Malho Amaciador



ref.	L (cm)	Ø (cm)		Bar Code
------	--------	--------	--	----------

762047	27	6	6/24	8411922456004
--------	----	---	------	---------------

Descapsulador

Bottle Opener
Décapsuleur
Flaschenöffner
Descapsulador



ref.	L (cm)		Bar Code
------	--------	--	----------

762028	19	6/72	8411922447789
--------	----	------	---------------

Descorazonador

Corer
Vide-Pomme
Entkerner
Descaroçador



ref.	L (cm)		Bar Code
------	--------	--	----------

762029	20	6/72	8411922447804
--------	----	------	---------------

Ruleta Corta Pastas

Pasta Cutting Wheel
Roulette Coupe-Pâtes
Nudelschneiderad
Roda de Corte para Massas



ref.	L (cm)		Bar Code
------	--------	--	----------

762034	18	6/72	8411922447859
--------	----	------	---------------

Espátula

Spatula
Spatule
Spatel
Espátula



ref.	L (cm)		Bar Code
762013	35	6/54	8411922447644

Cuchara

Spoon
Cuillère
Löffel
Colher



ref.	L (cm)		Bar Code
762015	33	6/54	8411922447668

Tenedor

Fork
Fourchette
Gabel
Garfo



ref.	L (cm)		Bar Code
762014	34	6/72	8411922447651

Batidor

Whisk
Fouet
Schneebeesen
Batedor



ref.	L (cm)		Bar Code
762017	31	6/36	8411922447682

Cuchara Pasta

Pasta Spoon
Cuillère Pâtes
Nudellöffel
Colher para Massas



ref.	L (cm)		Bar Code
762016	32	6/54	8411922447675

Pala para Pescado

Fish Server
Pelle pour Poisson
Fischschaufel
Pá de Peixe



ref.	L (cm)		Bar Code
762019	32	6/36	8411922447705

Rallador

Grater
Râpe
Reibe
Ralador



ref.	L (cm)		Bar Code
762026	27	6/72	8411922447774

Batidor Silicona

Silicone Whisk
Fouet Silicone
Silikon-Schneebeesen
Batedor de Silicone



ref.	L (cm)		Bar Code
762018	28	6/36	8411922447699

Abrelatas

Tin Opener
Ouvre-Boîte
Dosenöffner
Abre-Latas



ref.	L (cm)		Bar Code
762030	21	6/36	8411922447811

Pincel de Silicona

Silicone Brush
Pinceau Silicone
Silikonbürste
Escova de Silicone



ref.	L (cm)		Bar Code
762027	22	6/72	8411922447781

Pala para Servir Tartas

Cake Server
Pelle pour Servir
Gâteaux
Schaufel zum Servieren von Torten
Pá para Servir Bolos



ref.	L (cm)		Bar Code
762037	26	6/48	8411922447880

Cuchillo para Queso

Cheese Knife
Couteau à Fromage
Käsemesser
Faca para Queijo



ref.	L (cm)		Bar Code
762049	26	6/72	8411922458336

Abrebotes

Can Opener
Ouvre-Bocaux
Deckelöffner
Abre-Boiões



ref.	L (cm)		Bar Code
762032	26	6/36	8411922447835

Cortapizzas

Pizza Cutter
Roulette à Pizza
Pizzaschneider
Cortador de Pizza



ref.	L (cm)		Bar Code
762036	20	6/72	8411922447873

Abrestras

Oyster Knife
Couteau à Huitres
Austernöffner
Abridor de Ostras



ref.	L (cm)		Bar Code
762038	17	6/48	8411922447897

Racionador de Helado

Ice Cream Scoop
Cuillère à Glace
Eiscreme-
Portionierer
Porcionador de
Gelado



ref.	L (cm)		Bar Code
762035	20	6/72	8411922447866

Cortador para Queso

Cheese Cutter
Coupe-Fromage
Käseschneider
Ralador de Queijo



ref.	L (cm)		Bar Code
762045	25	6/72	8411922448061

Espátula Nylon

Nylon Spatula
Spatule Nylon
Nylon Spatel
Espátula de Nylon



ref.	L (cm)		Bar Code
762020	36	6/54	8411922447712

Cuchara Nylon

Nylon Spoon
Cuillère Nylon
Nylon Löffel
Colher de Nylon



ref.	L (cm)		Bar Code
762022	33	6/54	8411922447736

Cacillo Nylon

Nylon Ladle
Louche Nylon
Nylon Schöpfkelle
Concha de Nylon



ref.	L (cm)		Bar Code
762021	32	6/36	8411922447729

Cuchara Pasta Nylon

Nylon Pasta Spoon
Cuillère Pâtes Nylon
Nylon Nudellöffel
Colher para Massas de
Nylon



ref.	L (cm)		Bar Code
762024	33	6/54	8411922447750

Rallador de Limon

Lemon Grater
Râpe à Citron
Zitronenreibe
Ralador de
Limão



ref.	L (cm)		Bar Code
762044	16	6/72	8411922448054

Mechador

Larding Needle
Aiguille à Larder
Spicknadel
Aguilha para Recheio



ref.	L (cm)		Bar Code
762043	42	6/54	8411922448047

Vaciador

Fruit Baller
Moule à Boules
Kugelausstecher
Cortador de Bolas



ref.	L (cm)		Bar Code
762039	17	6/72	8411922448009

Prensa Patatas

Potato Masher
Presse Purée
Kartoffelpresse
Amasador de Batatas



ref.	L (cm)		Bar Code
762041	28	6/36	8411922448023

Pelatomates

Tomato Peeler
Éplucheur de Tomates
Tomatenschäler
Pelatomates



ref.	L (cm)		Bar Code
762042	20	6/72	8411922448030

Pelapatatas

Potato Peeler
Éplucheur de Pommes de Terre
Kartoffelschäler
Descascador de Batatas



ref.	L (cm)		Bar Code
762033	19	6/72	8411922447842

Pelapatatas "Y"

"Y" Potato Peeler
Éplucheur de Pommes de Terre "Y"
"Y" Kartoffelschäler
Descascador de Batatas "Y"



ref.	L (cm)		Bar Code
762040	17	6/72	8411922448016

Descorazonador para Tomate

Tomato Corer
Vide-Tomate
Tomatenausstecher
Descaroçador de Tomates



ref.	L (cm)		Bar Code
762046	17	6/72	8411922448078

Cuchillo - Espátula para Mantequilla

Butter Knife - Spatula
Couteau - Spatule à Beurre
Buttermesser - Spatel
Faca - Espátula para Manteiga



ref.	L (cm)		Bar Code
762050	19	6/72	8411922458343

Espumadera Nylon

Nylon Skimmer
Écumoire Nylon
Nylon Schaumlöffel
Escumadeira de Nylon



ref.	L (cm)	Ø (cm)		Bar Code
762023	34	11	6/36	8411922447743

NEW

Rallador Curvo

Curved Grater
Râpe Courbe Intense
Gebogene Reibe
Ralador Curvo

ref.	L (cm)	W (cm)	H (cm)		Bar Code
762053	29,50	6	2,30	6/72	8411922475227





NEW

Cuchara

Spoon
 Cuillère
 Löffel
 Colher



ref.	L (cm)	W (cm)	H (cm)		Bar Code
667100	33,10	6,90	5,10	6/36	8411922475326

NEW

Cuchara Pasta

Pasta Spoon
 Cuillère à Pâtes
 Nudellöffel
 Colher para Massas



ref.	L (cm)	W (cm)	H (cm)		Bar Code
667101	33,80	6	5,20	6/36	8411922475333

NEW

Espumadera

Skimmer
 Écumoire
 Schaumlöffel
 Escumadeira



ref.	L (cm)	W (cm)	H (cm)		Bar Code
667102	35,20	11,10	2,80	6/36	8411922475340

NEW

Cacillo

Ladle
 Louche
 Schöpflöffel
 Concha



ref.	L (cm)	W (cm)	H (cm)		Bar Code
667103	32,50	9,30	7,30	6/36	8411922475357

NEW

Espátula

Spatula
 Spatule
 Spatel
 Espátula



ref.	L (cm)	W (cm)	H (cm)		Bar Code
667104	34,80	9,50	2,70	6/36	8411922475364



Espumadera ClásicaClásica Skimmer
Écumoire Clásica
Schaumlöffel Clásica
Escumadeira Clásica

ref.	Ø (cm)	L (cm)		Bar Code
710300	11	35	12/48	8411922622140

Cacillo ClásicaClásica Ladle
Louche Clásica
Schöpfkelle Clásica
Concha Clásica

ref.	Ø (cm)	L (cm)		Bar Code
710400	9	30	12/72	8411922622157

Cacillo Salsas ClásicaClásica Sauce Ladle
Louche Sauces Clásica
Soßenkelle Clásica
Colher para Molhos Clásica

ref.		Bar Code
710401	12/72	8411922208030

Espátula ClásicaClásica Spatula
Spatule Clásica
Pfannenwender Clásica
Espatula Clásica

ref.	L (cm)		Bar Code
710500	33	12/72	8411922622164

Cuchara ClásicaClásica Spoon
Cuillère Clásica
Löffel Clásica
Colher Clásica

ref.	L (cm)		Bar Code
710600	34	12/72	8411922622171

Tenedor ClásicaClásica Fork
Fourchette Clásica
Gabel Clásica
Garfo Clásica

ref.		Bar Code
710700	12/72	8411922622188

Cuchara con Agujeros ClásicaClásica Spoon with Holes
Cuillère à Trous Clásica
Löffel mit Löchern Clásica
Colher Perfurada Clásica

ref.	L (cm)		Bar Code
710800	34	12/72	8411922622195

Cuchara Pasta ClásicaClásica Pasta Spoon
Cuillère Pâtes Clásica
Nudellöffel Clásica
Colher para Massas Clásica

ref.		Bar Code
710900	12/72	8411922622201

CacilloLadle
Louche
Schöpfkelle
Concha

ref.	L (cm)		Bar Code
712900	30	12/72	8411922423518

EspumaderaSkimmer
Écumoire
Schaumlöffel
Escumadeira

ref.	∅ (cm)	L (cm)		Bar Code
712800	11	33	12/72	8411922423501

EspátulaSpatula
Spatule
Pfannenwender
Espatula

ref.	L (cm)		Bar Code
713000	33	12/72	8411922423525

CucharaSpoon
Cuillère
Löffel
Colher

ref.	L (cm)		Bar Code
713100	34	12/72	8411922423532

TenedorFork
Fourchette
Gabel
Garfo

ref.	L (cm)		Bar Code
713200	35	12/72	8411922423549

Soporte Alambre UtensiliosWire Utensil Stand
Support pour Ustensiles en Fil
Utensilienständer aus Draht
Suporte de Utensílios de Arame

ref.	L (cm)		Bar Code
759701	41,50	1/8	8411922204391

CucharaSpoon
Cuillère
Löffel
Colher

ref.	L (cm)	H (cm)		Bar Code
733903	32	7	12/72	8411922087161

EspumaderaSkimmer
Écumoire
Schaumlöffel
Escumadeira

ref.	L (cm)	H (cm)		Bar Code
733900	33	1	12/72	8411922087130

Cacillo

Ladle
Louche
Schöpfkelle
Concha



ref.	L (cm)	H (cm)		Bar Code
733901	30	8,50	12/72	8411922087147

Espátula

Spatula
Spatule
Spatel
Espatula



ref.	L (cm)	H (cm)		Bar Code
733902	32	8	12/72	8411922087154

Utensilios.

Prisma.

ACERO INOXIDABLE
STAINLESS STEEL
ACIER INOXYDABLE
ROSTFREIER STAHL
AÇO INOXIDÁVEL

Espumadera Malla

Mesh Skimmer
Écumoire Maille
Netzschaumlöffel
Escumadeira de Malha



ref.	Ø (cm)	L (cm)		Bar Code
764410	10	34	6/72	8411922203820
764412	12	39	6/72	8411922205640

Cacillo Mini

Mini Ladle
Louche Mini
Mini-Schöpfkelle
Concha Mini



ref.	Ø (cm)	H (cm)		Bar Code
733804	4	14	6/240	8411922087116
733806	6	22	6/120	8411922087123

Utensilios.

Nylon.

NYLON
NYLON
NYLON
NYLON



Espátula para Tortillas

Spatula for Omelettes
Spatule pour Omelettes
Pfannenwender für Omelette
Espatula para Tortilha



ref.	L (cm)	W (cm)		Bar Code
682800	28	6	6/96	8411922456257

Espátula Larga para Crepes

Long Crepe Spatula
Spatule à Crêpes Longue
Langer Spatel für Crepes
Espátula longa para Crepes



ref.	L (cm)		Bar Code
738760	32	6/144	8411922454376

Pala para Lasaña / Plancha

Lasagne/Grill Spatula
Spatule pour Lasagne/Planche
Lasagne/Grill Spatel
Espátula para Lasanha/Chapa



ref.	L (cm)		Bar Code
738750	30	6/72	8411922451511

Espátula para Plancha

Grill Spatula
Spatule pour Planche
Grill Spatel
Espátula para Chapa



ref.	L (cm)	W (cm)		Bar Code
738700	32	10	6/36	8411922093261

Cacillo para Aceitunas

Olive Ladle
Louche à Olives
Olivenlöffel
Concha para Azeitonas

ref.	L (cm)	Ø (cm)		Bar Code
719106	24	6,50	6/72	8411922449419
719110	28	8	6/72	8411922448160

TAMAÑO PEQUEÑO/SMALL SIZE



Utensilios.

Nylon
Soft.

NYLON
NYLON
NYLON
NYLON
NYLON



Cuchara

Spoon
Cuillère
Löffel
Colher



ref.	L (cm)		Bar Code
734051	31	12/72	8411922450088

Cacillo

Ladle
Louche
Schöpfkelle
Concha



ref.	L (cm)		Bar Code
734050	31	12/72	8411922450071

Espátula

Spatula
Spatule
Spatel
Espatla



ref.	L (cm)		Bar Code
734052	31,50	12/72	8411922450095

Cuchara Pasta

Pasta Spoon
Cuillère Pâtes
Pasta-Löffel
Colher para Massa



ref.	L (cm)		Bar Code
734053	30	12/72	8411922451009

Espumadera

Skimmer
Écumoire
Schaumlöffel
Escumadeira



ref.	L (cm)		Bar Code
734054	31	12/72	8411922451016

**Espumadera**

Skimmer
 Écumoire
 Schaumlöffel
 Escumadeira



ref.	L (cm)		Bar Code
772700	34	12/72	8411922077735

Espátula

Spatula
 Spatule
 Spatel
 Espátula



ref.	L (cm)		Bar Code
772800	34	12/72	8411922077742

Cuchara

Spoon
 Cuillère
 Löffel
 Colher



ref.	L (cm)		Bar Code
773000	33,50	12/72	8411922077766

Cacillo

Ladle
 Louche
 Schöpfkelle
 Concha



ref.	L (cm)		Bar Code
772900	30	12/72	8411922077759

Cuchara Pasta

Pasta Spoon
 Cuillère Pâtes
 Nudellöffel
 Colher para Massa



ref.	L (cm)		Bar Code
773050	31	12/72	8411922079135

Espumadera

Skimmer
 Écumoire
 Schaumlöffel
 Escumadeira



ref.	Ø (cm)	L (cm)		Bar Code
759000	11	35	12/96	8411922621761

Cacillo

Ladle
 Louche
 Schöpfkelle
 Concha Suprema



ref.	Ø (cm)	L (cm)		Bar Code
759100	9	32	12/96	8411922621778

Cuchara

Spoon
 Cuillère
 Löffel
 Colher



ref.	L (cm)		Bar Code
759200	31	12/96	8411922621785

Espátula Larga

Long Spatula
 Spatule Longue
 Langer Spatel
 Espátula Longa



ref.	L (cm)		Bar Code
759300	32	12/96	8411922621792

**Espumadera**Skimmer
Écumoire
Schaumlöffel
Escumadeira

ref.	L (cm)		Bar Code
757300	11	12/144	8411922600339

CacilloLadle
Louche
Schöpfkelle
Concha

ref.	Ø (cm)		Bar Code
757600	9	12/144	8411922600308

CucharaSpoon
Cuillère
Löffel
Colher

ref.	L (cm)		Bar Code
757700	31	12/144	8411922600315

EspátulaSpatula
Spatule
Spatel
Espátula

ref.	L (cm)		Bar Code
757800	33	12/144	8411922600322

**Set 6 Utensilios + Soporte Colorful**Set 6 Utensils + Stand Colourful
Jeu 6 Ustensiles + Support Colorful
Set 6 Utensilien + Ständer Corlorful
Jogo 6 utensílios + Suporte Colorful

- Nylon
- Soft Touch
- **Evita el contacto del alimento con las diferentes superficies de la cocina, mejorando así la limpieza e higiene**
- Nylon
- Soft Touch
- Prevents food from coming into contact with the various kitchen surfaces, improving cleanliness and hygiene

ref.		Bar Code
740500	1/4/8	8411922434835

Utensilios.

Madera.

MADERA DE HAYA

BEECH WOOD
BOIS DE HÊTRE
BIENENHOLZ
MADEIRA BEECH



Espátula para Tortillas

Spatula for Omelettes
Spatule pour Omelettes
Pfannenwender für Omelette
Espatula para Tortilha



ref.	L (cm)		Bar Code
685400	28,50	6/36	8411922458459

Cuchara Española

Spanish Spoon
Cuillère Espagnole
Spanischer Löffel
Colher Espanhola



ref.	L (cm)		Bar Code
747422	22	6/72	8411922437515
747425	25	6/72	8411922437522
747430	30	6/36	8411922437539

Cuchara Redonda

Round Spoon
Cuillère Ronde
Runder Löffel
Colher Redonda



ref.	L (cm)		Bar Code
747625	25	6/96	8411922437560
747630	30	6/36	8411922437577

Tenedor

Fork
Fourchette
Gabel
Garfo



ref.	L (cm)		Bar Code
747515	15	6/72	8411922437546
747522	22	6/72	8411922437553
747530	30	6/36	8411922438598

Pinza - Tijera de Madera

Wooden Scissor Tongs
Ciseaux Pince en Bois
Scheren-Zange aus Holz
Pinça Tesoura de Madeira



ref.	L (cm)		Bar Code
742300	28	6/36	8411922439915

Servidor para Miel

Honey Spoon
Cuillère à Miel
Honig-Servierer
Servidor de Mel



ref.	L (cm)		Bar Code
747918	18	6/72	8411922437607

Espátula

Spatula
Spatule
Spatel
Espátula



ref.	L (cm)		Bar Code
747730	30	6/36	8411922437584

Espátula Perforada

Perforated Spatula
Spatule Perforée
Perforierter Spatel
Espátula Perforada



ref.	L (cm)		Bar Code
747830	30	6/36	8411922437591

Espumadera

Skimmer
Écumoire
Schaumlöffel
Escumadeira



ref.	L (cm)		Bar Code
746630	30	6/36	8411922439236

Pala para Pescado

Fish Server
Pelle à Poisson
Fischschaufel
Pá para Peixe



ref.	L (cm)	W (cm)		Bar Code
683100	30	12	6/36	8411922456943

Espátula para Wok

Wok Spatula
Spatule pour Wok
Wok-Spatel
Espátula para Wok



ref.	L (cm)	W (cm)		Bar Code
751430	30	6	6/36	8411922445039

Espátula Inclinada

Angled Spatula
Spatule Inclinée
Angewinkelte Spatel
Espátula Inclinada



ref.	L (cm)	W (cm)		Bar Code
751530	30	6	6/36	8411922445046

Pala - Espátula XL

Shovel - Spatula XL
Pelle - Spatule XL
Schaufel - Spatel XL
Pá - Espátula XL



ref.	L (cm)	W (cm)		Bar Code
747734	34	8,60	6/36	8411922449921

Cuchara para Confituras

Marmalade Spoon
Cuillère à Confiture
Marmeladenlöffel
Colher para Compota



ref.	L (cm)		Bar Code
755918	18	6/72	8411922453942

Servidor para Pasta

Spaguetti Server
Cuillère Spaghetti
Pasta Löffel
Colher par Spaguete



ref.	L (cm)	W (cm)		Bar Code
686900	30,50	6,30	6/36	8411922459494

Mazo Tenderizador

Meat Tenderiser
Attendrisseur à Viande
Fleischhammer
Maço Amaciador



ref.	L (cm)	Ø (cm)		Bar Code
686800	32	5	6/24	8411922459487

Rodillo con Asas

Rolling Pin with Handles
Rouleau avec Anses
Nudelholz mit Griffen
Rolo com Pegas



ref.	L (cm)	∅ (cm)	📦	Bar Code
747920	43	4,40	6/24	8411922453508
747930	43	6,50	6/12	8411922453515

Cuchara Eco

Eco Spoon
Cuillère Eco
Löffel Eco
Colher Eco



- **Madera de Haya**
- **Mango redondo. Sin revestimiento.**
- Beech Wood
- Round handle. Without coating.

ref.	L (cm)	📦	Bar Code
747625R	25	6/72	8411922453539
747630R	30	6/36	8411922453546
747635R	35	6/36	8411922453737
747640R	40	6/36	8411922453744

Espátula para Crepes Eco

Eco Crepe Spatula
Spatule à Crêpes Eco
Crêpe Spatel Eco
Espátula para Crepes Eco



- **Madera de Haya**
- **Mango redondo. Sin revestimiento.**
- Beech Wood
- Round handle. Without coating.

ref.	L (cm)	📦	Bar Code
716513	13	6/36	8411922455311
716518	18	6/36	8411922455328

Tenedor Eco

Eco Fork
Fourchette Eco
Gabel Eco
Garfo Eco



- **Madera de Haya**
- **Mango redondo. Sin revestimiento.**
- Beech Wood
- Round handle. Without coating.

ref.	L (cm)	📦	Bar Code
747522R	22	6/72	8411922453553
747530R	30	6/36	8411922453560

Espatula Perforada Eco

Eco Perforated Spatula
Spatule Perforée Eco
Perforierter Spatel Eco
Espátula perforada Eco



- **Madera de Haya**
- **Mango redondo. Sin revestimiento.**
- Beech Wood
- Round handle. Without coating.

ref.	L (cm)	📦	Bar Code
747830R	30	6/36	8411922453577

Cuchara/Espátula para Sangría

Spoon/Spatula for Sangria
Cuillère/Spatule pour Sangria
Löffel/Spatel für Sangria
Colher/Espátula para Sangria



ref.	L (cm)	📦	Bar Code
755833	33,50	6/72	8411922448528

Pinza Multiusos Eco

Eco Multipurpose Tongs
Pincas Multi-Usages Eco
Mehrzweck Zange Eco
Pinça Multiusos Eco



ref.	L (cm)		Bar Code
716730	30	6/36	8411922455335
716732	32	6/36	8411922455342
716740	40	6/36	8411922455359

Espumadera L

Skimmer L
Écumoire L
Schaumlöffel L
Espumadera L



ref.	L (cm)		Bar Code
689400	34	6/36	8411922471069

Jamonero Kompakto

Kompakto Ham Holder
Porte-Jambon Kompakto
Kompakto Schinkenhalter
Suporte para Presunto Kompakto



- **Madera de Caucho**
- **Acero Inoxidable**
- **Ajustable a todos los tamaños de jamón**
- **Fácil de montar y de guardar**
- Rubber Wood
- Stainless Steel
- Adjustable to all sizes of hams
- Easy to assemble and storage

ref.	L (cm)	W (cm)		Bar Code
684200	40	17	1/6	8411922457407

Pinza Magnética Multiusos

Multi-Purpose Magnetic Tong
Pince Magnétique Multi-Usages
Mehrzweckzange mit Magnet
Pinça Magnética Multiusos



- **Bambú**
- **Bamboo**

ref.	L (cm)		Bar Code
709400	28	6/36	8411922441413
709422	22	20	8411922448085

Espátula L

Spatula L
Spatule L
Kelle L
Espátula L



ref.	L (cm)		Bar Code
689300	33	6/36	8411922471052

Cuchara para Arroz

Rice Spoon
Cuillère à Riz
Reislöffel
Colher para Arroz



ref.	L (cm)		Bar Code
689500	21	6/72	8411922471076



Cuchara Oliva

Oliva Spoon
Cuillère Oliva
Löffel Oliva
Colher Oliva



- **Madera de Olivo**
- **Revestimiento de Aceite**
- Olive Wood
- Oil Coating

ref.	L (cm)		Bar Code
689600	30	6/36	8411922471243

Tenedor Oliva

Oliva Fork
Fourchette Oliva
Gabel Oliva
Garfo Oliva



- **Madera de Olivo**
- **Revestimiento de Aceite**
- Olive Wood
- Oil Coating

ref.	L (cm)		Bar Code
689700	30	6/36	8411922471250

Espátula Oliva

Oliva Spatula
Spatule Oliva
Kelle Oliva
Espátula Oliva



- **Madera de Olivo**
- **Revestimiento de Aceite**
- Olive Wood
- Oil Coating

ref.	L (cm)		Bar Code
689800	30	6/36	8411922471267

Espátula Perforada Oliva

Oliva Perforated Spatula
Spatule Perforée Oliva
Kelle Perforiert Oliva
Espátula Perfurada Oliva



- **Madera de Olivo**
- **Revestimiento de Aceite**
- Olive Wood
- Oil Coating

ref.	L (cm)		Bar Code
689900	30	6/36	8411922471274

NEW

Plato para Pulpo / Queso / Embutidos

Plate for Octopus / Cheese / Cold meats
Plat pour Poulpe / Fromage / Charcuterie
Teller für Kalmar / Kase / Aufschnitt
Prato para Polvo / Queijo / Enchidos



- **Madera de Acacia**
- **Revestimiento de Aceite**
- Acacia Wood
- Oil Coating



ref.	Ø (cm)	H (mm)		Bar Code
691216	16	21,50	4/24	8411922475661
691218	18	21,50	4/24	8411922475678
691220	20	21,50	4/24	8411922475685
691222	22	21,50	4/24	8411922475692
691224	24	21,50	4/24	8411922475708
691226	26	21,50	4/24	8411922475715
691228	28	21,50	4/24	8411922475722



Palillos (8 uds.)

Chopsticks
Baguettes
Essstäbchen
Panzinhos



ref.	L (cm)		Bar Code
683500	24	6/72	8411922457025

Pinchos de Bambú Lazo (50 uds.)

Bamboo Prikkers Lazo
Piques en Bambou Lazo
Bambus-Spieße Lazo
Espetos de Bambu Lazo



ref.	L (cm)		Bar Code
752209	9	6/144	8411922441789

Pinchos de Bambú

Bamboo Prikkers
Piques en Bambou
Bambus-Spieße
Espetos de Bambu



ref.	L (cm)		Bar Code	
752109	9	6/144	8411922441765	70 uds
752118	18	6/144	8411922441772	50 uds

Brochetas de Bambú

Bamboo Skewers
Brochettes en Bambou
Bambus-Spieße
Espetos de Bambu



ref.	L (cm)		Bar Code	
753620	20	12/72	8411922084917	100 uds
753630	30	6/48	8411922084924	50 uds

Utensilios.

Portautensilios.

ACERO INOXIDABLE
STAINLESS STEEL
ACIER INOXYDABLE
ROSTFREIER STAHL
AÇO INOXIDÁVEL

Portautensilios Premier

Premier Utensil Holder
Porte-Ustensiles Premier
Utensilienhalter Premier
Porta Utensilios Premier



ref.	∅ (cm)		Bar Code
708700	12	6/48	8411922076257
708706	6,50	6/144	8411922081473
708710	10	6/72	8411922081480

Portautensilios Porcelana

Porcelain Utensil Holder
Porte-Ustensiles Porcelaine
Porzellan Utensilienhalter
Porta-Utensílios de Porcelana



- Porcelana
- Porcelain

ref.	∅ (cm)	H (cm)		Bar Code	
748601	12	14	6/12	8411922438291	NEGRO/BLACK
748602	12	14	6/12	8411922438307	ROJO/RED

Portautensilios Giratorio

Rotating Utensil Holder
Porte-Ustensiles Rotatif
Drehbarer Utensilienhalter
Porta-Utensílios rotativo



ref.	∅ (cm)	H (cm)	📦	Bar Code
797200	14	18	4	8411922433012

Portautensilios Rectangular

Rectangular Utensil Holder
Porte-Ustensiles Rectangulaire
Rechteckiger Utensilienhalter
Porta-Utensílios Retangular



ref.	L (cm)	H (cm)	📦	Bar Code
797250	22	18	4	8411922433029

Escurrecubiertos

Cutlery Drainer
Égouttoir à Couverts
Küchenutensilienhalter
Escorredor de Talheres



ref.	∅ (cm)	H (cm)	📦	Bar Code
714000	8	13	6/72	8411922203929

Portautensilios de Cocina

Utensil Holder
Porte-Ustensiles
Küchenutensilienhalter
Porta Utensílios de Cozinha



ref.	∅ (cm)	H (cm)	📦	Bar Code
714100	10	18	6/48	8411922203936

Portautensilios Americano

American Utensils Holder
Porte-Ustensiles Américain
Amerikanischer Küchenutensilienhalter
Porta Utensílios Americano



ref.	∅ (cm)	H (cm)	Lts	📦	Bar Code
700512	12	16	1,80	6/48	8411922447057

Portautensilios con Jabonera

Kitchen Soap Dispenser Caddy
Porte-Ustensiles avec Distributeur de Savon
Utensilienhalter mit Seifenschale
Porta-Utensílios com Saboneteira



ref.	L (cm)	W (cm)	H (cm)	📦	Bar Code
797220	18	12,50	8,50	1/6	8411922457889

Portacubiertos

Cutlery Bucket
Pot Range-Couverts
Besteckhalter
Porta-Talheres



ref.	L (cm)	W (cm)	H (cm)	📦	Bar Code
797210	18	8,60	13	1/6	8411922457872

Colgador de Barra

Utensil Hanging Bar Rack
Barre de Suspension
Hängeleiste
Cabide de Barra



ref.	L (cm)	📦	Bar Code
764540	40	6/36	8411922208986
764550	50	6/36	8411922203844

Utensilios Varios.



Utensilios
Varios.

Centrifugadoras.

PLÁSTICO
PLASTIC
PLASTIQUE
KUNSTSTOFF
PLÁSTICO



Centrifugadora para Ensalada Essential

Essential Salad Spinner
Essoreuse à Salade Essential
Salatschleuder Essential
Centrifugadora de Salada Essential



- Con freno · Antideslizante
- With brake · Non-slip

ref.	∅ (cm)	∩	Bar Code
783620	20	1/6	8411922083828
783626	26	1/6	8411922083835

Centrifugadora para Ensalada Confort

Confort Salad Spinner
Essoreuse à Salade Confort
Salatschleuder Confort
Centrifugadora de Salada Confort



- A manivela · Antideslizante
- Via crank · Non-slip

ref.	∅ (cm)	∩	Bar Code
783120	20	1/6	8411922434309
783124	24	1/4	8411922083293

Centrifugadora para Ensalada a Pedal Function

Function Salad Spinner via Pedal
Essoreuse à Salade à Pédale Function
Pedal Salatschleuder Function
Centrifugadora de Salada a Pedal Function



ref.	∅ (cm)		Bar Code
783016	16	1/6	8411922083279
783024	24	1/4	8411922083286

Utensilios
Varios.

Exprimidores.

Exprimidor Inox

Stainless Steel Juicer
Presse-Agrumes Inox
Edelstahl-Saftpresse
Espremedor Inox



- Acero Inoxidable 18/10
- Stainless Steel 18/10



ref.	∅ (cm)	Lts		Bar Code
765700	10	0,40	1/24	8411922208733

Exprimidor para Cítricos

Citrus Juicer
Presse-Agrumes de Citriques
Zitruspresse
Espremedor de Citrinos



- Plástico
- Más cantidad con menos esfuerzo
- Plastic
- Less effort, more juice



ref.	L (cm)	W (cm)		Bar Code
788500	25	9	6/24	8411922089554

Exprimidor para Limones

Lemon Juicer
Presse-Agrumes de Citrons
Zitronenpresse
Espremedor de Limão



- Aluminio
- Aluminium

ref.	∅ (cm)		Bar Code
782310	6	6/24	8411922439977

Exprimidor para Limas

Lime Juicer
Presse-Agrumes de Citrons Verts
Limettenpresse
Espremedor de Limas



- Aluminio
- Aluminium

ref.	∅ (cm)		Bar Code
782410	5	6/24	8411922439984



Molde Hamburguesa Luxe

Luxe Hamburger Mold
Moule Hamburger Luxe
Hamburger Form Luxe
Molde de Hambúrguer Luxe



- Aluminio
- Aluminium

ref.	∅ (cm)		Bar Code
748000	11	6/24	8411922437638

Molde Hamburguesa

Hamburger Mold
Moule Hamburger
Hamburger Form
Molde de Hambúrguer



- Aluminio
- Aluminium

ref.	∅ (cm)	H (cm)		Bar Code
748001	6	8	1/6/120	8411922454635
748002	9	8	1/6/72	8411922454642

Prensa Hamburguesas

Burger Press
Presse Steak Haché
Hamburgerpresse
Prensa para Hambúrgueres



- Acero Inoxidable
- Stainless Steel

ref.	∅ (cm)	H (cm)		Bar Code
702650	14,50	6,50	1/6/24	8411922474404

NEW

Papel Separador de Hamburguesas (100 uds.)

Hamburguer Patty Paper
Papier à Steak Haché
Burgerpapier
Papier para Hambúrgueres



- Papel
- Paper



non-stick

ref.	∅ (cm)		Bar Code
690811	11	12/144	8411922475050

NEW

Molde Hamburguesa Inox

Stainless Steel Burger Mold
Moule Hamburger Inox
Hamburger Form aus Edelstahl
Molde de Hambúrguer Inox



- Acero Inoxidable
- Stainless Steel

ref.	∅ (cm)		Bar Code
666909	9	6/36	8411922475142
666911	11,40	6/24	8411922475159



Molde Hamburguesa Redondo

Round Hamburger Mold
Moule Hamburger Rond
Runde Hamburgerform
Forma de Hambúrguer Redonda



- Plástico
- Plastic

ref.	∅ (cm)		Bar Code
777201	11	1/6/48	8411922080186

Molde Hamburguesa Cuadrado

Square Hamburger Mold
Moule Hamburger Carré
Quadratische Hamburgerform
Forma de Hambúrguer Quadrada



- Plástico
- Plastic

ref.	L (cm)		Bar Code
777200	8,50	1/6/72	8411922080179

Utensilios
Varios.

Molinillos.

Molinillo para Pimienta Mini

Mini Pepper Mill
Moulin à Poivre Mini
Mini-Pfeffermühle
Moinho de Pimenta Mini



- Aluminio
- Aluminium

ref.	∅ (cm)	H (cm)		Bar Code
790400	3	15	6/60	8411922090512

Molinillo para Pimienta/Sal Eléctrico

Electric Pepper/salt Mill
Moulin à Poivre/Sel Électrique
Elektrische Pfeffer-/Salzmühle
Moedor Elétrico de Pimenta/Sal



- Acero Inoxidable 18/10
- Stainless Steel 18/10



4xAAA
included

ref.	L (cm)		Bar Code
778600	22	6/30	8411922081008

Molinillo para Pimienta Elegance

Elegance Pepper Mill
Moulin à Poivre Elegance
Pfeffermühle Elegance
Moinho de Pimenta Elegance



- Madera
- Muela de cerámica
- Wood
- Ceramic grinder

ref.	H (cm)		Bar Code
773416	15	1/6/24	8411922078121
773421	20	1/6/24	8411922078138
773431	30	1/6/24	8411922078145

Molinillo para Pimienta Natural

Natural Pepper Mill
Moulin à Poivre Natural
Pfeffermühle Natural
Moinho de Pimenta Natural



- Madera
- Muela de cerámica
- Wood
- Ceramic grinder

ref.	H (cm)		Bar Code
773316	15	1/6/24	8411922078077
773321	20	1/6/24	8411922078084
773331	30	1/6/24	8411922078107

Molinillo para Pimienta Red

Red Pepper Mill
Moulin à Poivre Red
Pfeffermühle Red
Moinho de Pimenta Red



- **Madera**
- **Muela de cerámica**
- Wood
- Ceramic grinder

ref.	H (cm)		Bar Code
773216	15	1/6/24	8411922441543
773221	20	1/6/24	8411922441550
773231	30	1/6/24	8411922441567

Molinillo para Pimienta Negro

Negro Pepper Mill
Moulin à Poivre Negro
Pfeffermühle Negro
Moinho de Pimenta Negro



- **Madera**
- Wood

ref.	H (cm)		Bar Code
774516	15	1/6/24	8411922449877
774521	20	1/6/24	8411922449884
774531	30	1/6/24	8411922449891

Molinillo para Pimienta Transparente

Transparent Pepper Mill
Moulin à Poivre Transparent
Transparente Pfeffermühle
Moinho de Pimenta Transparente



- **PMMA**
- **Muela de cerámica**
- PMMA
- Ceramic grinder

ref.	H (cm)	∅ (cm)		Bar Code
683414	14	5,50	1/6/24	8411922456998
683416	16	5,50	1/6/24	8411922457001
683418	18	5,50	1/6/24	8411922457018

Molinillo para Sal/Pimienta Mini Colores

Mini Salt/Pepper Mill Colours
Moulin à Sel/Poivre Mini Couleurs
Salz/Pfeffermühle Mini Farben
Moinho para Sal/Pimenta Mini Cores



- **Plástico**
- **Muela de cerámica**
- Plastic
- Ceramic grinder

ref.	∅ (cm)	H (cm)		Bar Code
689000	5,80	10	12/72	8411922470758

Utensilios
Varios.

Morteros.



Mano para Mortero

Pestle for Mortar
Pilon pour Mortier
Stöbel Für Mörser
Pistilo para Almofariz



- **Madera de Haya**
- **Universal**
- Beech Wood
- Universal

ref.	L (cm)		Bar Code
684500	19	6/36	8411922457865

Mortero de Mármol

Marble Mortar
Mortier Marbre
Marmor Mörser
Almofariz de Mármore



- **Mármol**
- **No poroso e higiénico**
- Marble
- Non porous and hygienic

ref.	∅ (cm)	H (cm)		Bar Code
780310	12	12	1/6	8411922444063

Mortero de Granito

Granite Mortar
Mortier Granite
Granit Mörser
Almofariz de Granito



- **Granito**
- Granite

ref.	∅ (cm)	H (cm)		Bar Code
780410	13	8	1/4	8411922444070

Mortero Inox

Stainless Steel Mortar
Mortier Inox
Edelstahl Mörser
Almofariz Inox



- **Acero Inoxidable**
- Stainless Steel



ref.	L (cm)	H (cm)		Bar Code
722600	13,50	7,50	1/6/12	8411922080209

Mortero de Bambú

Bamboo Mortar
Mortier de Bambou
Mörser aus Bambus
Almofariz de Bambu



- **Bambú**
- Bamboo

ref.	∅ (cm)	H (cm)		Bar Code
752050	10	11	6	8411922456530
752060	14	11	1/6	8411922475197

NEW

Utensilios
Varios.

Embudos.



Embudo para Confituras

Funnel for Jams
Entonnoir à Confitures
Trichter für Marmeladen
Funil para Compotas



- **Acero Inoxidable 18/10**
- Stainless Steel 18/10

ref.	∅ (cm)		Bar Code
739614	5,5-14	6/72	8411922433715

Embudo con Filtro

Funnel with Filter
Entonnoir avec Filtre
Trichter mit Filter
Funil com Filtro



- **Acero Inoxidable 18/10**
- Stainless Steel 18/10

ref.	∅ (cm)		Bar Code
763800	10	6/72	8411922203103

Embudo Plegable

Collapsible Funnel
Entonnoir Pliable
Trichter Faltbar
Funil Dobrável



- **Silicona**
- Silicone

ref.	∅ (cm)	∩	Bar Code
744600	9,50	6/162	8411922436471
744610	12,50	6/48	8411922470871

Embudo para Reciclaje de Aceite Doméstico

Household Oil Recycling Funnel
Entonnoir pour Recyclage de L'Huile
Haushaltsöl-Recycling-Trichter
Funil de Reciclagem de Óleo Doméstico



- **Plástico**
- **El embudo se adapta a las botellas de plástico de refresco y agua**
- Plastic
- The funnel adapts to plastic soft drink and water bottles

ref.	∅ (cm)	H (cm)	∩	Bar Code
781900	10	9	12	8411922082791

Utensilios
Varios.

Jarras.

Jarra de Agua para Nevera

Water Jug for Fridge
Pichet D'Eau pour Réfrigérateur
Kühlschrankkrug
Jarro de Água para Frigorífico



- **Borosilicato**
- **Acero Inoxidable**
- **Para puerta de nevera**
- Borosilicate
- Stainless Steel
- For refrigerator door

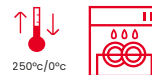

ref.	Lts	∅ (cm)	H (cm)	∩	Bar Code
626011	1,10	8	24	6	8411922452976
626015	1,50	9	28	6	8411922452983

Jarra de Agua para Nevera Class

Class Water Jug for Fridge
Pitchet en verre
Wasserkrug
Jarro de vidro para água



- Borosilicato
- Acero Inoxidable
- Para puerta de nevera
- Filtro Inox
- Borosilicate
- Stainless Steel
- For refrigerator door
- Stainless Steel filter

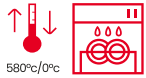

ref.	L (cm)	W (cm)	H (cm)	Lts		Bar Code
628318	17	8,50	23	1,50	1/6/12	8411922470864

Jarra de Agua

Water Jug
Pichet d'Eau
Wasserkrug
Jarro de Água



- Vidrio
- Tapa plástica
- Glass
- Plastic lid

ref.	L (cm)	W (cm)	H (cm)	Lts		Bar Code
743825	8	8	15,70	0,60	1/6	8411922476101
743850	8	8	23,50	1,10	6	8411922457940
743875	11	8,50	26	1,80	6	8411922470345

Jarra de Agua con Retén

Water Jug with Stopper
Pichet d'Eau avec Retenu
Wasserkrug mit Stopper
Jarro de Água com Retentor



- Acero Inoxidable
- Stainless Steel

ref.	Lts		Bar Code
711620	2	1/12	8411922622287

Jarra de Agua Recta

Straight Water Jug
Pichet d'eau Droite
Wasserkrug Gerade
Jarro de Agua Recto



- Acero Inoxidable
- Stainless Steel

ref.	Lts		Bar Code
721820	2	4/12	8411922079999

Lechera

Milk Churn
Laiterie
Milchkanne
Leiteira



- Aluminio
- Aluminium

ref.	∅ (cm)	H (cm)	Lts		Bar Code
151215	11,50	21,50	1,50	1/6	8411922459081
151220	12	20,50	2	1/6	8411922459098

Abridor de Latas y Tarros Easycook

Jar and Tin Opener Easycook
Ouvre-Boîtes et Bocaux Easycook
Dosen- und Glasöffner Easycook
Abre-Latas e Abre-Jarras Easycook



- Acero Inoxidable
- Plástico
- Stainless Steel
- Plastic

ref.	L (cm)	W (cm)		Bar Code
743600	20	6	6/24	8411922436112

Abrelatas + Abrebotellas + Abrebotes Confort

Confort Can Opener + Bottle Opener + Jar Opener
Ouvre-Boîtes + Ouvre-Bouteilles + Ouvre-Bocaux
Confort
Dosenöffner + Flaschenöffner + Glasöffner Confort
Abre-Latas + Abre-Garrafas + Abre-Frascos Confort



- Plástico
- Acero Inoxidable
- Plastic
- Stainless Steel

ref.	L (cm)		Bar Code
739002	14	12/48	8411922093506

Abretarros Easy Open

Jar Opener Easy Open
Ouvre-Bocaux Easy Open
Topföffner Easy Open
Abridor de Frascos Easy Open



- Plástico
- Plastic

ref.	L (cm)		Bar Code
750100	14	24/120	8411922439199



Abrebotes Easy Open

Jar Opener Easy Open
Ouvre-Bocaux Easy Open
Topföffner Easy Open
Abridor de Frascos Easy Open



- Plástico
- Elimina el vacío
- Plastic
- Pops the vacuum

ref.	L (cm)		Bar Code
743300	14	10/120	8411922435924

Abrebotes

Jar Opener
Ouvre-Bocaux
Topföffner
Abridor de Frascos



- Acero Inoxidable
- Stainless Steel

ref.	L (cm)	W (cm)		Bar Code
774700	16	10	6/72	8411922079562

Abridor de Tarros y Botellas Múltiple

Jar and Bottle Opener
Ouvre-Boîtes et Bouteilles
Flaschen- und Deckelöffner
Abridor de Frascos e Garrafas



- Plástico
- Goma
- Plastic
- Rubber

ref.	L (cm)	W (cm)		Bar Code
763300	22,50	8,50	6/24/72	8411922446128

Utensilios
Varios.

Marisco.



Rompemarisco + 2 Tenedores

Seafood Cracker + 2 Forks
Pince à Fruits de Mer + 2 Fourchettes
Zange für Meeresfrüchte + 2 Gabeln
Quebra Marisco + 2 Garfos



- Acero Inoxidable
- Stainless Steel

ref.	L (cm)		Bar Code
781400	18-24	6/24	8411922082494

Tenaza para Marisco + 4 Tenedores

Lobster Cracker + 4 Forks
Pince à Crustacés + 4 Fourchettes
Zange + 4 Gabeln für Meeresfrüchte
Pinças de Marisco + 4 Garfos



- Acero Inoxidable
- Stainless Steel

ref.	L (cm)		Bar Code
684900	18+20,50	6/36	8411922458022

Tenaza para Marisco

Seafood Cracker
Pince à Fruits de Mer
Zange für Meeresfrüchte
Quebra Marisco



- Acero Inoxidable
- Stainless Steel

ref.	L (cm)		Bar Code
781500	18	6/12	8411922082500

Rompemarisco

Seafood Cracker
Pince à Fruits de Mer
Zange für Meeresfrüchte
Quebra Marisco



- Acero Cromado
- Chrome Steel

ref.	L (cm)		Bar Code
785800	16	12/24	8411922085242

Cuchillo para Ostras Basic

Basic Oyster Knife Basic
Couteau à Huîtres Basic
Austernmesser Basic
Faca para Ostras Basic



- Acero Inoxidable
- Stainless Steel

ref.	L (cm)		Bar Code
681100	16,50	6/48	8411922454468

Rompemarisco / Cascanueces Basic

Basic Seafood Cracker / Nutcracker
Pince à Fruits de Mer / Casse-Noix Basic
Zange für Meeresfrüchte / Nussknacker Basic
Quebra Marisco / Quebra-Nozes Basic



- Aleación de Zinc
- Zinc Alloy



ref.	L (cm)		Bar Code
628800	16	6/48	8411922472110

Utensilios
Varios.

Mallas y Filtros.

Hilo Alimentario para Matanzas

Kitchen Twine
Fil Alimentaire pour Abattage
Küchengarn
Fio de cozinha



- Algodón
- Cotton



ref.	m		Bar Code
730710	250	1/6	8411922448252

Hilo de Cocina con Dispensador

Kitchen Twine with Dispenser
Fil de Cuisine avec Distributeur
Küchengarn mit Spender
Fio de Cozinha com Dispensador



- Rayón
- Rayon



ref.	L (cm)		Bar Code
795500	600	12/72	8411922093643

Aguja para Bridar

Trussing Needle
Aiguille à Brider
Dressiernadel
Aguilha de Cozinha



- Acero Inoxidable
- Stainless Steel

ref.	Cms		Bar Code
796000	18	6/288	8411922093711

Hilo de Cocina

Kitchen Twine
Fil Alimentaire
Küchengarn
Fio de Cozinha



- Rayón
- Rayon



ref.	L (cm)		Bar Code
771200	600	12/96	8411922077827

Malla Elástica para Carne

Elastic Mesh for Meat
Maille Élastique pour Viande
Elastisches Fleischnetz
Rede Elástica para Carne



- Algodón
- Poliester
- Cotton
- Polyester

ref.	L (cm)		Bar Code
777702	200	1/6	8411922080308

Malla para Legumbres

Mesh Bag for Legumes
Sac à Légumes
Gemüsenetz
Saco para Legumes



- Nylon
- Nylon

ref.	L (cm)	W (cm)	Kg		Bar Code
779000	30	5	2	1/6	8411922081206
779010	37	10	4	6	8411922446555

Set 2 Fundas para Rodillo de Amasar

Set 2 Covers for Kneading Roller
Jeu 2 Étuis pour Rouleau de Pâtisserie
Set 2 Nudelholz-Abdeckung
Jogo 2 Coberturas para Rolo de Amassar



- Algodón
- Poliester
- Cotton
- Polyester

ref.	L (cm)		Bar Code
746650	38	6/96	8411922451658

Bolsas para Fruta

Fruit Bags
Sac pour Fruits
Fruchtsäcke
Sacos para fruta



- PET
- Reutiliza y recicla · Ligera y transpirable
- PET
- Reuse & recycle · Light & breathable



ref.	L (cm)	W (cm)		Bar Code
702310	30+35+43	20+30+30	6/48	8411922453324

Paño para Queso

Cheese Cloth
Chiffon à Fromage
Käsetuch
Pano para Queijo



- Algodón
- Paso 770µm
- Cotton
- Pitch 770µm



max. 60°



ref.	L (cm)	W (cm)		Bar Code
746400	50	50	6	8411922436853

Tela de Estameña

Muslin Cloth
Tissu Étamine
Schablonen-Tuch
Tela de Gaze



- Algodón
- Paso 358µm
- Cotton
- Pitch 358µm



max. 60°



ref.	L (cm)	W (cm)		Bar Code
746450	50	50	6	8411922436860

Saco para Jamón

Ham Sack
Sac pour Jambon
Schinkenbeutel
Saco para Presunto



- Algodón
- Poliester
- Cotton
- Polyester

ref.	L (cm)		Bar Code
777609	90	1/6	8411922080292

Bola de Malla para Especies

Spice Ball Mesh
Boule à Maille pour Épices
Gewürzkugel aus Mesh
Bola de Malha para Especiarias



- Acero Inoxidable 18/10
- Stainless Steel 18/10



ref.	∅ (cm)		Bar Code
779510	10	6/36	8411922081893

Bolsa Filtro para Leche Vegetal

Filter Bag for Plant Milk
Sac Filtre pour Lait Végétal
Planzenmilchbeutel
Saco Filtro para Leite Vegetal



- Algodón
- Todo tipo de frutos secos, cereales y semillas
- Cotton
- All types of nuts, cereals and seeds

ref.	L (cm)	W (cm)		Bar Code
706550	34	25,50	6	8411922456400

Bola para Cocido

Cooking Ball
Boule pour Pot-au-Feu
Kochkugel für Eintopf
Esfera para Cozidos



- Acero Inoxidable 18/10
- Stainless Steel 18/10



ref.	∅ (cm)		Bar Code
768414	14,50	6/24	8411922209006

Filtro para Especies

Spice Strainer
Infuseur à Herbes et Épices
Gewürzsieb
Filtro para Especiarias



- Acero Inoxidable
- Stainless Steel



ref.	L (cm)	W (cm)		Bar Code
688800	11	4,50	6/144	8411922470710





Separador de Yemas Múltiple

Multiple Egg Yolk Separator
Séparateur de Jaunes D'Oeufs Multiple
Mehrfacher Eigelbtrenner
Separador de Gemas Multiplio

- ABS
- Regulable
- ABS
- Adjustable



ref.	L (cm)	W (cm)		Bar Code
682300	29	12	1/6/48	8411922455939

Separador de Yemas Inox

Stainless Steel Egg Yolk Separator
Séparateur de Jaunes d'Oeuf Inox
Edelstahl Eigelb-Separator
Separador de Gema de Ovo Inox



- Acero Inoxidable 18/10
- Stainless Steel 18/10

ref.	L (cm)		Bar Code
709500	17	6/96	8411922076929

Separador de Yemas

Egg Yolk Separator
Séparateur à Oeuf
Eigelbtrenner
Separador de Gemas



- Plástico
- Con apoyo para bowl
- Plastic
- With bowl hanger

ref.	L (cm)	W (cm)	H (cm)		Bar Code
739300	10	7	4	6/96	8411922433531



Utensilios Varios.

Parrillas.

ACERO INOXIDABLE 18%

STAINLESS STEEL 18%
ACIER INOXYDABLE 18%
ROSTFREIER STAHL 18%
AÇO INOXIDÁVEL 18%



Parrilla Besuguera Inox

Stainless Steel Fish Wire Grill
Grill à Poisson
Edelstahl-Fischgrill
Grelhador de Peixe Inox



ref.	L (cm)	W (cm)	📦	Bar Code
770100	42	19	2/4	8411922072266

Parrilla Pescado Inox

Stainless Steel Fish Wire Grill
Grill à Poisson Inox
Edelstahl-Fischgrill
Grelhador de Peixe Inox

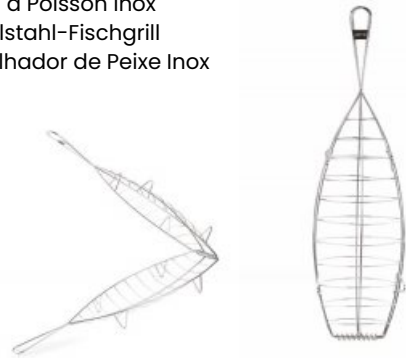

ref.	L (cm)	W (cm)	📦	Bar Code
769745	45	16	2/6	8411922161304

Parrilla Rodaballo Inox L

Stainless Steel Fish Wire Grill L
Grill à poisson L
Edelstahl-Fischgrill L
Grelhador de Peixe L



ref.	L (cm)	W (cm)	📦	Bar Code
770250	31	21	2/6	8411922459814

Parrilla Rodaballo Inox XL

Stainless Steel Fish Wire Grill XL
Grill à Poisson XL
Edelstahl-Fischgrill XL
Grelhador de Peixe XL



ref.	L (cm)	W (cm)	📦	Bar Code
770200	42	30	2/4	8411922072273

Parrilla Doble 12 Kokotxas / Espárragos

Double Grill for 12 Fish Cheeks / Asparagus
Grill Double 12 Kokotxas / Asperges
Rost, 2-Geteilt, 12 Cocochas / Spargel
Grelha Dupla para 12 Cocochas / Espargos

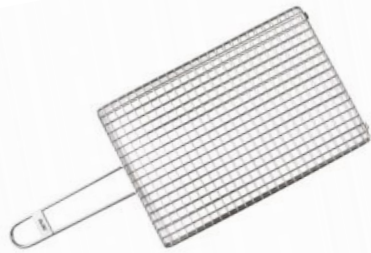
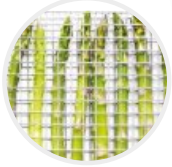

- **Rodajas de verdura**
- **Carne**
- **Bacon, etc...**
- Sliced vegetables
- Meat
- Bacon, etc...

ref.	L (cm)	W (cm)	H (cm)	⌘ (cm)	📦	Bar Code
770400	30	20	1	1x1	2/6	8411922471144

Parrilla Doble 6 Kokotxas / Vieiras

Double Grill for 6 Fish Cheeks / Scallops
Grill Double 6 Kokotxas / Coquiles
Rost, 2-Geteilt, 6 Cocochas / Jacobsmuschel
Grelha Dupla para 6 Cocochas / Vieiras

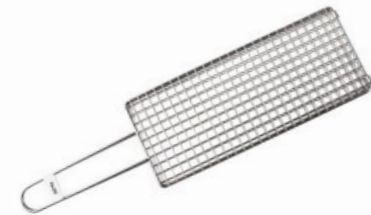

- **Rodajas de verdura**
- **Carne**
- **Bacon, etc...**
- Sliced vegetables
- Meat
- Bacon, etc...

ref.	L (cm)	W (cm)	H (cm)	⌘ (cm)	📦	Bar Code
770401	30	12	1	1x1	2/6	8411922471151

Parrilla Doble Sardinias / Pulpo

Double Grill for Sardines / Octopus
Grill Double Sardines / Poulpe
Rost, 2-Geteilt, Sardinien / Kalmar
Grelha Dupla para Sardinhas / Polvo

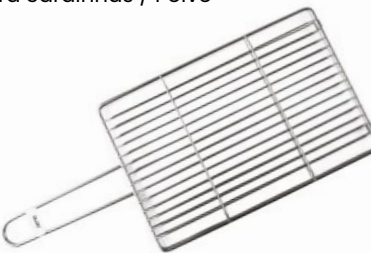

- **Rodajas de salmón y de bonito**
- **Langostinos**
- **Salchichas, hamburguesas, etc...**
- Slices of salmon and tuna
- Prawns
- Sausages, hamburgers, etc...

ref.	L (cm)	W (cm)	H (cm)	⌘ (cm)	📦	Bar Code
770402	30	20	2	1	2/6	8411922471168

Parrilla Doble Calamares

Double Grill for Squids
Grill Double Calamars
Rost, 2-Geteilt, Kalmare
Grelha Dupla para Calamares



- **Evita que asomen tentáculos de los calamares.**
- **Rodajas o tiras de verduras o carne**
- **Bacon, etc...**
- Prevents squid tentacles from falling through the holes
- Slices or thin strips of vegetables or meat
- Bacon, etc...

ref.	L (cm)	W (cm)	H (cm)	⌘ (cm)	📦	Bar Code
770403	30	20	1	0,5x0,5	2/6	8411922471175

Parrilla / Cesto Almejas / Verduras

Grill / Basket for Clams / Vegetables
 Grill / Panier Palourdes / Légumes
 Rost/Korb Muscheln/Gemüse
 Grelha / Cesto para Amêijoas / Vegetais



- Crustaceos y mariscos
- Champiñones
- Pimientos y alcachofas
- Crustacean ans seafood
- Mushrooms
- Peppers and artichokes

ref.	L (cm)	W (cm)	H (cm)	⊞ (cm)	📦	Bar Code
770404	24	13	8	1x1	2/6	8411922471182

Sartén para Barbacoa

Barbecue Frying Pan
 Poêle pour Barbecue
 Barbecue-Pfanne
 Frigideira para Churrasco



- Acero Inoxidable 18/10
- Almejas, navajas, marisco
- Champiñones
- Pimientos, calabacín, alcachofas
- Stainless Steel 18/10
- Clams, razor clams, seafood
- Mushrooms
- Peppers, courgette or artichokes

ref.	∅ (cm)	H (cm)	L (cm)	📦	Bar Code
665628	28	6	50	2/6/24	8411922474947

Grill Piedra Redondo

Round Stone Grill
 Grill Pierre Rond
 Runder Steingrill
 Pedra para Grelhar Redonda

- Acero Inoxidable
- Piedra
- 3 quemadores
- Stainless Steel
- Stone
- 3 burners



ref.	∅ (cm)	H (cm)	📦	Bar Code
755050	30	1,80	1/2	8411922455489

Repuesto Piedra Redonda

Round Grill Replacement Stone
 Pierre Rechange pour Grill Rond
 Runder Ersatzstein
 Pedra Redonda de Reposição

- Piedra
- Stone



ref.	∅ (cm)	H (cm)	📦	Bar Code
755050P	30	1,80	1	8411922455922



Grill Piedra Rectangular

Rectangular Grill Stone
Grill Pierre Rectangulaire
Rechteckiger Steingrill
Pedra para Grelhar Retangular



- **Acero Inoxidable**
- **Piedra**
- Stainless Steel
- Stone



ref.	L (cm)	W (cm)		Bar Code
755000	37	18	1/2	8411922087291

Repuesto Piedra Rectangular

Rectangular Grill Replacement Stone
Pierre Rechange pour Grill Rectangulaire
Rechteckiger Ersatzstein
Pedra Retangular de Reposição



- **Piedra**
- Stone



ref.	L (cm)	W (cm)		Bar Code
755000P	37	18	1/3	8411922093957

Colgador para 3 Brochetas

Rack for 3 Skewers
Support pour 3 Brochettes
Ständer für 3 Spieße
Suporte para 3 Espetadas



- **Acero Inoxidable**
- Stainless Steel



ref.	H (cm)	Ø (cm)		Bar Code
628500	50	23	6	8411922471120

Set 6 Brochetas Planas

Set 6 Flat Skewers
Ensemble 6 Brochettes Plates
Bratspiesse Flach, 6 stk.
Set 6 Espetos Planos

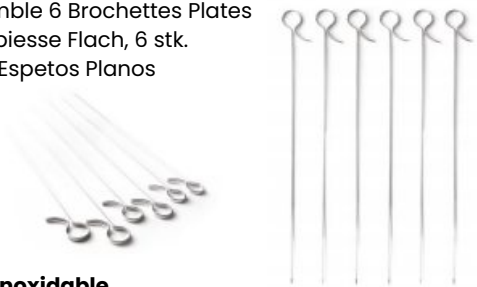

- **Acero Inoxidable**
- Stainless Steel



ref.	L (cm)		Bar Code
628600	40	6/48	8411922471137

Utensilios
Varios.

Orden y
Limpieza.

Reposautensilios de Silicona

Utensil Holder
Repose-Ustensiles
Kochlöffelständer
Base para Pousar Utensilios



- **Silicona**
- Silicone

ref.	L (cm)	W (cm)		Bar Code
685350	13,70	13,50	6/36	8411922458268

Reposacucharas

Spoon Stand
Support pour Cuillère
Löffelständer
Porta-Colheres



- **Acero Inoxidable**
- Stainless Steel

ref.	L (cm)	W (cm)		Bar Code
743700	22	10	6/48	8411922436150

Reposautensilios con Cuchara

Utensil Stand with Spoon
Support pour Ustensiles avec Cuillère
Utensilienhalter mit Löffel
Suporte de Utensílios com Colher



- **Madera**
- **Acero Inoxidable 18/10**
- Wood
- Stainless Steel 18/10

ref.	W (cm)	H (cm)		Bar Code
769000	9,50	17,20	1/24	8411922209457

NEW

Organizador de Latas Nevera

Can Organizer
Organisateur de Canettes
Dosenhalter
Organizador de Latas



- **Plástico**
- Plastic



ref.	L (cm)	W (cm)	H (cm)		Bar Code
691000	35	14,20	10	3/6	8411922475180

Organizador de Cajones

Drawer Organizer
Organisateur de Tiroirs
Schubladenorganisator
Organizador de Gavetas

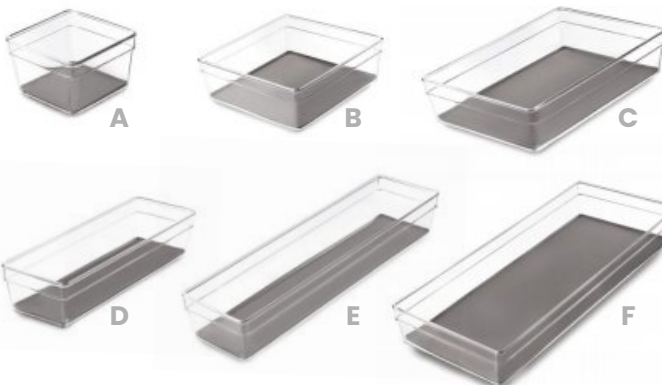

- **Plástico**
- **Silicona**
- **Material antideslizante · 4 puntos de apoyo**
- Plastic
- Silicone
- Non-slip material · 4 non-slip feet

ref.	L (cm)	W (cm)	H (cm)		Bar Code	
690108	8	8	5,50	6/24	8411922445152	A
690115	15,50	15,50	5,50	6/24	8411922445183	B
690122	22,80	15,50	5,50	6/12	8411922445190	C
690124	24,50	8	5,50	6/24	8411922445169	D
690132	32,50	8	5,50	6/24	8411922445176	E
690138	38,30	15,50	5,50	6/12	8411922446104	F

Cubertero

Cutlery Holder
Plateau pour Couverts
Einlage
Organizador de Talheres



- Plástico
- Silicona
- Plastic
- Silicone

ref.	L (cm)	W (cm)	H (cm)		Bar Code
690233	33,50	27	5,50	3/6/12	8411922446111

Huevera 18 Unidades

Egg Holder 18 Eggs
Boîte à 18 Oeufs
Eierhalter für 18 Eier
Caixa para Ovos 18 Unidades



- Plástico
- Plastic



ref.	L (cm)	W (cm)	H (cm)		Bar Code
690018	33	17	8	6	8411922457223

Cesta para Huevos

Egg Basket
Panier à Oeufs
Eierkorb
Cesto para Ovos



- Acero Cromado
- Chrome Steel

ref.	∅ (cm)	H (cm)		Bar Code
684700	19,50	13	3/6	8411922457971

Soporte Dispensador de Papel

Paper Towel Holder
Support pour Papier Essuie-Tout
Küchenrollenhalter
Suporte para Papel de Cozinha



- Acero Inoxidable
- Plástico
- Con ventosa
- Stainless Steel
- Plastic
- With suction base

ref.	H (cm)		Bar Code
712200	33	6	8411922454529

Escurridor para Platos y Cubiertos Aluminio

Aluminium Dish and Cutlery Drainer
Égouttoir à Vaisselle et Couverts en Aluminium
Aluminium Geschirrabtropfer und Besteckkasten
Escorredor de Pratos e Talheres em Alumínio



- Plástico
- Aluminio
- Plastic
- Aluminium

ref.	L (cm)	W (cm)		Bar Code
720700	41	20	1/4	8411922439298

Escurridor Eco

Eco Drainer
Égouttoir Eco
Geschirrabtropfstander Eco
Escorredor Eco



- Plástico
- Plastic

ref.	L (cm)	W (cm)	H (cm)		Bar Code
721600	44	22	13	1/6	8411922441529

Alfombrilla Escurreplatos

Dish Drainer Mat
Tapis D'Égouttage pour Vaisselle
Geschirr-Abtropfmatte
Tapete Escorredor de Pratos



- **Silicona**
- Silicone

ref.	L (cm)	W (cm)		Bar Code
685300	40	30	6/36	8411922458251

Atril Plegable Class

Class Folding Book Stand
Pupitre Pliable Class
Klappbarer Buchständer Class
Atril Dobravel Class



- **Acero Cromado**
- **También para ebooks o tablets**
- Chrome Steel
- Also for ebooks or tablets

ref.	L (cm)	W (cm)	H (cm)		Bar Code
728750	15	9	13	6/48	8411922449976

Atril para Libro de Cocina

Cookbook Stand
Support pour Livre de Cuisine
Kochbuch-Ständer
Suporte para Livro de Cozinha



- **Acero Inoxidable**
- Stainless Steel

ref.	L (cm)	W (cm)		Bar Code
728000	20	17	1/6	8411922084931

Set 2 Colgadores de Trapos

Set 2 Dish Rag Holders
Jeu 2 Porte-Torchons
Set 2 Saughaken
Jogo 2 Suportes para Pendurar Panos



- **Plástico**
- Plastic

ref.	∅ (cm)		Bar Code
681200	5	6/144	8411922454475

Recogemigas

Crumb Cleaner
Ramasse-Miettes
Krümelsammler
Recogemigas



- **Acero Inoxidable**
- Stainless Steel



ref.	L (cm)	W (cm)	H (cm)		Bar Code
722400	21,50	6,50	2,70	1/6/60	8411922080148

NEW

Recogemigas Confort

Confort Crumb Sweeper
Ramasse-Miettes Confort
Krümelsammler Comfort
Apanha-migalhas Conforto



- **Acero Inoxidable**
- Stainless Steel



ref.	L (cm)	W (cm)	H (cm)		Bar Code
691300	20	4,70	2	6/36	8411922475739

Set 6 Especieros + Soporte Giratorio

Set 6 Spice Jars + Rotating Stand
Jeu 6 Porte-Épices + Support Rotatif
Set 6 Gewürzgläser + Drehbarer Ständer
Jogo 6 Frascos para Especiarias + Suporte Giratório



- **Plástico**
- Plastic

ref.	∅ (cm)	H (cm)		Bar Code
797710	18	21,50	1/6/12	8411922441598

Clip Magnético para Bolsas (4 uds.)

Clip for Bags with Magnet (4 pcs)
Clip pour Sacs avec Aimant (4 pcs)
Magnet-Beutelclip (4 stk.)
Clipes com Iman para Sacos (4 uds.)



- **Plástico**
- **Acero Inoxidable**
- Plastic
- Stainless Steel



ref.	L (cm)		Bar Code
717700	7,50	6/96	8411922448627

Clip para Bolsas (4 uds.)

Clip for Bags (4 pcs)
Clip pour Sacs (4 pcs)
Beutelclip (4 stk.)
Clipes para Sacos (4 uds.)



- **Plástico**
- Plastic

ref.	L (cm)		Bar Code
717800	9	6/288	8411922448900

Cepillo para Fregadero

Sink Brush
Brosse à Vaisselle
Spülbürste
Escova de Pia



- **Plástico**
- **Permite limpiar vajilla, ollas, fuentes de horno, etc... con manchas resistentes con mayor facilidad y rapidez**
- Plastic
- Enables you to remove stubborn stains from dishes, pots, oven dishes, etc... more quickly and easily



ref.	L (cm)		Bar Code
680400	24	6/24	8411922449785

Cepillo para Cacerolas con Dispensador de Jabón

Pan Brush with Soap Dispenser
Brosse à Marmites avec Distributeur de Savon
Töpfe Bürste mit Seifenspender
Escova para Panelas com Dispensador de Sabão



- **Plástico**
- Plastic



ref.	L (cm)	W (cm)		Bar Code
735800	10	8,50	12/72	8411922089127

Dispensador para Detergente

Detergent Dispenser
Distributeur de Détergent
Spülmittelspender
Dispensador de Detergente



- **Plástico**
- **Incluye estropajo-esponja**
- Plastic
- Includes scourer-sponge

Esponja de Esmeril para Cacerolas y Sartenes

Emery Sponge for Casseroles and Frying Pans
Éponge en Émeri pour Casseroles et Poêles
Scheuerschwamm für Töpfe und Pfannen
Esponja de Esmeril para Caçarolas e Frigideiras



- **Perfecta para recuperar/limpiar utensilios metálicos**
- Perfect for cleaning/recovering metal utensils

ref.	L (cm)	W (cm)		Bar Code
680500	16	7	6/24	8411922449792

ref.	L (cm)	W (cm)	H (cm)		Bar Code
682400	10	2,50	2,50	6/48	8411922455946

Rejilla Filtro para Fregadero

Sink Filter Grid
Grille de Filtre d'Évier
Spülbecken-Filter
Grelha Filtro para Pia da Cozinha



- **Acero Inoxidable**
- Stainless Steel

ref.	∅ (cm)		Bar Code
730907	7	6/120	8411922451375
730909	9	6/120	8411922451382
730911	11,50	6/120	8411922451399

Filtro de Malla para Fregadero

Mesh Sink Strainer
Filtre Maillé pour Évier
Abflusssieb
Filtro de Rede para Pia



- **Acero Inoxidable**
- Stainless Steel

ref.	∅ (cm)		Bar Code
687507	7,50	6/120	8411922459821

Cepillo para Verduras

Vegetable Brush
Brosse à Légumes
Gemüsebürste
Escova para Legumes



- ABS
- ABS



ref.	L (cm)	W (cm)	📦	Bar Code
783300	8	6	6/72	8411922083316

Rejilla para Fregadero

Sink Strainer
Grille pour Évier
Spülbecken-Sieb
Grelha para Pia



- Plástico
- Plastic

ref.	L (cm)	Ø (cm)	H (cm)	📦	Bar Code
748300	11	7	3	6/96	8411922437676

Rasqueta Vitrocerámica

Vitroceramic Scraper
Racloir Vitrocéramique
Vitrokeramik-Schaber
Raspador Vitrocerâmica



- Acero Inoxidable 18/10
- Stainless Steel 18/10



ref.	L (cm)	📦	Bar Code
708200	13	6/144	8411922074970

Repuestos Rasqueta Vitrocerámica (3 uds.)

Vitroceramic Scraper Blades (3 pcs)
Lames pour Racloir Vitrocéramique (3 pcs)
Vitrokeramik-Schaber Klängen (3 stk.)
Reposto Raspador Vitrocerâmica (3 uds.)



- Acero Inoxidable
- Stainless Steel



ref.	📦	Bar Code
708250	24/144	8411922081961

Papelera de Barra

Table Bin
Poubelle de Table
Tischeimer
Caixote do Lixo de Mesa



- Acero Inoxidable 18/10
- Stainless Steel 18/10

ref.	Ø (cm)	H (cm)	📦	Bar Code
769200	11,70	16,50	1/12	8411922209471

Cubo para Reciclaje

Recycling Bin
Poubelle pour Recyclage
Recycling-Treiteimer
Balde para Reciclagem



- Acero Inoxidable
- Cuerpo metálico
- Cubo interior plástico extraíble
- Mecanismo de pedal
- Stainless Steel
- Metallic body
- Removable plastic inner bucket
- Pedal mechanism

ref.	Lts	L (cm)	W (cm)	H (cm)	📦	Bar Code
796711	8	29	17	40	1/4	8411922453683
796721	15	34	20	46	1/4	8411922453690

Librador de Madera

Wooden Scoop
Pelle en Bois
Holzschaukel
Pá de Servir de Madeira



- Madera de Haya
- Beech Wood



ref.	L (cm)		Bar Code
683210	10	6/72	8411922456950
683214	14	6/72	8411922456967
683217	17	6/36	8411922456974

Librador

Scoop
Pelle à Farine
Schaufel
Colhere de Servir



- Acero Inoxidable
- Stainless Steel



ref.	L (cm)		Bar Code
749924	24	6/72	8411922439045
749928	28	6/72	8411922439052

Set 3 Libradores

Set 3 Scoops
Jeu 3 Pelles
Set 3 Schaufeln
Jogo 3 Pás de Servir



- Plástico
- Plastic

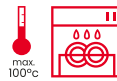

ref.	L (cm)		Bar Code
723300	16,5+19+21,5	1/12/36	8411922449815

ACERO INOXIDABLE
STAINLESS STEEL
ACIER INOXYDABLE
ROSTFREIER STAHL
AÇO INOXIDÁVEL



Set 6 Cucharillas Presentación

Set 6 Presentation Teaspoons
Jeu 6 Cuillère Présentation
Set 6 Präsentation Teelöffel
Jogo 6 Colheres de Apresentação



ref.	L (cm)	H (cm)		Bar Code
731600	13	4,50	6/60	8411922086133

Pluma para Decorar Platos

Decorating Spoon Pen
Cuillère Pluma
Dekorierlöffel
Colher Caneta para Decorar Pratos



ref.	L (cm)		Bar Code
740900	17	6/120	8411922435108
740921	21	6/120	8411922441888

Cuchara para Esferificaciones

Spoon for Spherifications
Cuillère pour Sphérifications
Löffel für Sphärisierungen
Colher para Esferificações



ref.	L (cm)		Bar Code
711700	18	6/120	8411922441871

Molde Nido

Nest Mold
Moule Nid
Nestbacklöffel
Forma Ninho



ref.	∅ (cm)		Bar Code
706300	8,5+10	6/72	8411922076264

Mini Cestillo Redondo

Round Mini-Basket
Mini Panier Rond
Mini-Runder Korb
Mini Cesto Redondo



ref.	∅ (cm)	H (cm)		Bar Code
751910	9	7,50	6/54	8411922093780

Bandeja de Mantequilla con Tapa

Butter Tray with Lid
Beurrier avec Couvercle
Butterdose mit Deckel
Manteigueira com Tampa



ref.	L (cm)	W (cm)		Bar Code
722900	19	12	1/6/36	8411922080575

Mini Cestillo Rectangular

Square Mini-Basket
Mini Panier Carré
Mini-Rechteckiger Korb
Mini Cesto Retangular



ref.	L (cm)	W (cm)		Bar Code
751900	10,50	9	6/54	8411922093773

Rabanera

Platter
Ravier
Platte
Pratinho



ref.	L (cm)	W (cm)		Bar Code
722013	13	6	6/204	8411922080025

Bajoplato

Shallow Dish
Dessous Assiette
Unterteller
Prato Marcador



ref.	∅ (cm)		Bar Code
715932	32	12/36	8411922070149

Salsera

Sauce Boat
Saucière
Soßenschüssel
Molheira



ref.	Lts		Bar Code
765500	0,23	6/60	8411922208764

Set 2 Soportes para Huevo Hervido

Set 2 Stands for Boiled Eggs
Jeu 2 Coquetiers
Set 2 Gekochte Eier Halter
Jogo 2 Suportes para Ovos Cozidos



ref.	∅ (cm)	H (cm)	📦	Bar Code
764650	5	4,50	6/108	8411922453393

Pinzas Sujetamantel (4 uds.)

Tablecloth Clips (4 pcs)
Pince à Nappe (10 pcs)
Tischtuch-Clips (4 stk.)
Clips para Toalhas de Mesa (4 uds.)



ref.	L (cm)	W (cm)	📦	Bar Code
725100	5	4	6/144	8411922448597

Salvamantel Extensible

Extendable Trivet
Dessous de Plat Extensible
Ausziehbarer Untersetzer
Descanso de Prato Estensível



ref.	L (cm)	W (cm)	📦	Bar Code
724500	45	20	6/24	8411922082104

Servilletero de Mesa "U"

"U" Shaped Napkin Holder
Rond de Serviette de Table "U"
"U" Förmiger Serviettenhalter
Porta-Guardanapos de Mesa "U"



ref.	L (cm)	W (cm)	📦	Bar Code
724600	11,50	11	6/60	8411922082111

Servilletero con Bola

Napkin Holder with Ball
Rond de Serviette avec Boule
Serviettenhalter mit Kugel
Porta-Guardanapos com Bola



ref.	L (cm)	W (cm)	📦	Bar Code
724700	17	17	1/16	8411922082128

Salvamantel Magnético

Magnetic Trivet / Pot Rest
Dessous de Plat Magnétique
Untersetzer, Magnetisch
Base Protetora Magnética



- Silicona
- Silicone



ref.	∅ (cm)	📦	Bar Code
688400	18	6/120	8411922470383

Salvamantel Cuadrado/Redondo

Square/Round Trivet
Dessous de Plat Carré/Rond
Quadratischer/Runder Untersetzer
Descanso de Prato Quadrado/Redondo



- Silicona
- Silicone



ref.	L (cm)	W (cm)	📦	Bar Code
776900	16	16	6/24	8411922088014

Temporizador de Cocina Digital

Digital Kitchen Timer
Minuteur de Cuisson Numérique
Digitaler Küchentimer
Termómetro Digital de Cozinha



- Plástico
- Con imán
- Plastic
- With magnet



2xAAA
NOT
included

ref.	L (cm)	W (cm)		Bar Code
743407	7	7	6/72	8411922441833

Temporizador de Cocina Digital Inox

Stainless Steel Digital Kitchen Timer
Minuterie de Cuisson Numérique Inox
Digitaler Edelstahl-Küchentimer
Temporizador Digital de Cozinha Inox



- Acero Inoxidable
- Con imán
- Stainless Steel
- With magnet



1xAAA
NOT
included

ref.	L (cm)	W (cm)		Bar Code
743411	7	6,40	6/72	8411922456271

Temporizador de Cocina Inox

Stainless Steel Kitchen Timer
Minuteur de Cuisson Inox
Edelstahl-Küchentimer
Temporizador de Cozinha Inox



- Acero Inoxidable
- Stainless Steel

ref.	L (cm)	W (cm)		Bar Code
743408	6	6	6/72	8411922441840



Barware.



Sacacorchos de Palanca Vertical Class

Class Vertical Lever Corkscrew
Tire-Bouchon à Levier Vertical Class
Senkrecht Hebelkorkenzieher Class
Saca-Rolhas Vertical de Alavanca Class

- Acero Inoxidable
- Plástico
- Soft Touch
- Stainless Steel
- Plastic
- Soft Touch



ref.	L (cm)		Bar Code
695001	16	1/6/12	8411922446166

Sacacorchos de Palanca Vertical Luxe

Luxe Vertical Lever Corkscrew
Tire-Bouchon à Levier Vertical Luxe
Senkrecht Hebelkorkenzieher Luxe
Saca-Rolhas Vertical de Alavanca Luxe

- Acero Inoxidable
- Plástico
- Stainless Steel
- Plastic



ref.	L (cm)		Bar Code
695003	16	1/6/12	8411922446180

Sacacorchos de Palanca Horizontal

Horizontal Lever Corkscrew
Tire-Bouchon à Levier Horizontal
Horizontaler Hebelkorkenzieher
Saca-Rolhas de Alavanca Horizontal

- Acero Inoxidable
- Plástico
- Stainless Steel
- Plastic



ref.	L (cm)		Bar Code
695004	18	1/6/12	8411922446197

Descorchador Giratorio con Alas

Self Pulling Corkscrew
Tire-Bouchon Rotatif avec Ailes
Drehkorkenzieher mit Flügeln
Saca-Rolhas Giratório com Pegas

- Acero Inoxidable
- Plástico
- Soft Touch
- Stainless Steel
- Plastic
- Soft Touch



ref.	L (cm)		Bar Code
695000	16	6/48	8411922446159

Sacacorchos Giratorio Confort

Confort Corkscrew
Tire-Bouchon Confort
Korkenzieher Confort
Saca-Rolhas Confort



- Acero Inoxidable
- Plástico
- Incluye cortacápsulas
- Stainless Steel
- Plastic
- Foil-cutter included

ref.	L (cm)		Bar Code
695043	17,50	6/48	8411922457384

Sacacorchos Eléctrico

Electric Corkscrew
Tire-Bouchon Électrique
Elektrischer Korkenzieher
Saca-Rolhas Elétrico



- Plástico
- Metálico
- Soft Touch
- Incluye cortacápsulas
- Plastic
- Metallic
- Soft Touch
- Foil-cutter included



ref.	L (cm)		Bar Code
695045	24	6/24	8411922457841

Sacacorchos Bodega

Wine Cellar Corkscrew
Tire-Bouchon Cave
Korkenzieher Weinkeller
Saca-Rolhas Bodega



- Acero Cromado
- Espiral fresada
- Chrome Steel
- Milled spiral

ref.	L (cm)		Bar Code
695040	15	6/48	8411922446784

Sacacorchos Giratorio Cerrado

Closed Rotary Corkscrew
Tire-Bouchon Rotatif Fermé
Geschlossener Drehkorkenzieher
Saca-Rolhas Giratorio Fechado



- Acero Inoxidable
- Plástico
- Stainless Steel
- Plastic

ref.	L (cm)		Bar Code
695008	12,50	6/48	8411922446234

Sacacorchos Doble Palanca Metálico

Metallic Double Lever Corkscrew
Tire-Bouchon Double Levier Métallique
Korkenzieher mit Doppelhebel aus Metal
Saca-Rolhas Metalico de Dupla Avalanca



- Acero Inoxidable
- Stainless Steel

ref.	L (cm)		Bar Code
695005	18	6/48	8411922446203

Sacacorchos Doble Palanca Class

Class Double Lever Corkscrew
Tire-Bouchon Double Levier Class
Korkenzieher mit Doppelhebel Class
Saca-Rolhas de Dupla Avalanca Class



- Acero Inoxidable
- Plástico
- Soft Touch
- Stainless Steel
- Plastic
- Soft Touch

ref.	L (cm)		Bar Code
695007	17	6/48	8411922446227

Sacacorchos Doble Palanca Eco

Eco Double Lever Corkscrew
Tire-Bouchon Double Levier Eco
Korkenzieher mit Doppelhebel Eco
Saca-Rolhas de Dupla Avaranca Eco

- Acero Cromado
- Plástico
- Chrome Steel
- Plastic



ref.	L (cm)		Bar Code
695006	17	6/48	8411922446210

Sacacorchos Doble Palanca Love

Love Double Lever Corkscrew
Tire-Bouchon Double Levier Love
Korkenzieher mit Doppelhebel Love
Saca-Rolhas de Dupla Avaranca Love

- Plástico
- Acero Cromado
- Plastic
- Chrome Steel



ref.	L (cm)		Bar Code
695044	17	6/48	8411922457834

Sacacorchos Doble Apoyo + Descapsulador

Double Support Corkscrew + Foil Cutter
Tire-Bouchon Double Support + Décapsuleur
Korkenzieher mit Doppelaufgabe + Folienschneider
Saca-Rolhas de Duplo Apoio + Corta Capsulas

- Acero Inoxidable
- Plástico
- Stainless Steel
- Plastic



ref.	L (cm)		Bar Code
695015	14,70	6/72	8411922446302

Sacacorchos 2 Tiempos Class

Class 2 Step Corkscrew
Tire-Bouchon 2 Temps Class
2 Fach Korkenzieher Class
Saca-Rolhas de 2 Movimentos Class

- Acero Inoxidable
- Plástico
- Stainless Steel
- Plastic



ref.	L (cm)		Bar Code
695016	11,50	6/72	8411922446319

Sacacorchos Camarero Luxe

Luxe Waiter Corkscrew
Tire-Bouchon Barman Luxe
Korkenzieher Kellner Luxe
Saca-Rolhas Garçom Luxe

- Acero Inoxidable
- Plástico
- Stainless Steel
- Plastic



ref.	L (cm)		Bar Code
695017	12	6/72	8411922446326

Sacacorchos + Abrechapas

Corkscrew + Bottle Opener
Tire-Bouchons + Ouvre-Bouteilles
Korkenzieher + Kapselöffner
Saca-Rolhas + Abre-Garrafas

- Acero Inoxidable
- Plástico
- Stainless Steel
- Plastic



ref.		Bar Code
784700	12/144	8411922085136

Sacacorchos Mayordomo

Butler Corkscrew
Tire-Bouchon Majordome
Korkenzieher Butler
Saca-Rolhas Mordomo

- **Acero Cromado**
- **Plástico**
- Chrome Steel
- Plastic



ref.	L (cm)		Bar Code
695009	11	6/72	8411922446241

Sacacorchos Doble Apoyo

Double Support Corkscrew
Tire-Bouchon à Double Support
Korkenzieher mit Doppelhebel
Saca-Rolhas Suporte Duplo

- **Acero Inoxidable**
- Stainless Steel



ref.	L (cm)		Bar Code
709100	12	6/72	8411922076905

Abridor de Champagne

Champagne Opener
Ouvre-Bouteilles Champagne
Champagneröffner
Abridor de Champanha

- **Acero Cromado**
- **Plástico**
- Chrome Steel
- Plastic



ref.	L (cm)		Bar Code
695010	17,50	6/48	8411922446258

Descapsulador Metal Luxe

Luxe Metallic Foil Cutter
Décapsuleur Métallique Luxe
Folienschneider aus Metal Luxe
Corta Capsulas de Metal Luxe

- **Metal**
- **Acero Inoxidable**
- Metal
- Stainless Steel



ref.	Ø (cm)		Bar Code
695018	6	6/72	8411922446333

Descapsulador Eco

Eco Foil Cutter
Décapsuleur Eco
Folienschneider Eco
Corta Capsulas Eco

- **Plástico**
- Plastic



ref.	L (cm)		Bar Code
695019	7	6/72	8411922446340

Bomba de Vacío Inox + 2 Tapones

Stainless Steel Vacuum Pump + 2 Stoppers
Pompe à Vide Inox + 2 Bouchons
Vakuumpumpe aus Edelstahl + 2 Deckel
Bomba de Vácuo Inox + 2 Tampões

- **Acero Inoxidable**
- **Silicona**
- Stainless Steel
- Silicone



ref.	L (cm)		Bar Code
695032	15	6/48	8411922446470

Tapones de Repuesto para Bomba de Vacío

Replacement Vacuum Pump Stoppers
Bouchons Recharge Pompe à Vide
Ersatzverschlüsse für Vakuumpumpe
Tampões de Reposição para Bomba de Vácuo

- **Silicona**
- Silicone



ref.	L (cm)		Bar Code
695039	5	6/72	8411922446548

Tapón para Vino con Bomba de Vacío

Wine Stopper with Vacuum Pump
Bouchon de Vin avec Pompe à Vide
Weinverschluss mit Vakuumpumpe
Tampão de Vinho com Bomba de Vácuo

- **Metal**
- Metal



ref.	L (cm)		Bar Code
695033	6	6/72	8411922446487

Tapón de Vacío Eco

Eco Vacuum Stopper
Bouchon Vide Eco
Weinverschluss mit Vakuumpumpe Eco
Tampão de Vácuo Eco

- Plástico
- Plastic



ref.	L (cm)		Bar Code
695041	5,80	6/120	8411922451528

Bomba de Vacío

Vacuum Pump
Pompe à Vide
Vakuumpumpe
Bomba de Vácuo

- Plástico
- Plastic



ref.	L (cm)		Bar Code
781100	14	1/6/48	8411922082456

Tapón para Champagne-Vino Ajustable

Adjustable Champagne & Wine Sealer
Bouchon à Champagne et Vin Réglable
Champagner und Weinverschluss
Tampão para Champahne e Vinho Ajustável

- Plástico
- Plastic



ref.	L (cm)		Bar Code
695002	6	6/72	8411922446173

Tapón para Champagne con Pulsador

Champagne Stopper with Push-Button
Bouchon à Champagne avec Poussoir
Champagnerdeckel mit Druckknopf
Tampão para Champahne com Pulsador

- Acero Inoxidable
- Silicona
- Stainless Steel
- Silicone



ref.	L (cm)		Bar Code
695011	5	6/72	8411922446265

Tapón para Champagne Eco

Eco Champagne Stopper
Bouchon à Champagne Eco
Champagnerdeckel Eco
Tampão para Champahne Eco

- Silicona
- Plástico
- Silicone
- Plastic



ref.	L (cm)		Bar Code
695012	4,50	6/72	8411922446272

Tapón para Cava Cromado

Chromed Champagne Stopper
Bouchon pour Cava Chromé
Verchromter Verschluss für Cava
Rolha para Cava Cromada

- Acero Inoxidable
- Silicona
- Stainless Steel
- Silicone



ref.		Bar Code
722500	1/6/72	8411922080155

Tapón para Vino Silver

Silver Wine Stopper
Bouchon de Vin Silver
Weinverschluss Silver
Tampão para Vinho Silver

- Metal
- Silicona
- Metal
- Silicone



ref.	L (cm)		Bar Code
695026	7	6/72	8411922446418

Set 2 Tapones Cónicos para Vino

Set 2 Conical Wine Stoppers
Jeu 2 Bouchons de Vin Coniques
2Er Set Konischer Weinverschluss
Conjunto de 2 Tampões Cónicos para Vinho

- Metal
- Silicona
- Metal
- Silicone



ref.	L (cm)		Bar Code
695028	6	6/72	8411922446432

Set 2 Tapones para Vino

Set 2 Stoppers for Wine
Jeu 2 Bouchons Vin
Set 2 Weinstopper
Jogo 2 Rolhas de Vinho



- TPR
- TPR

ref.		Bar Code
785300	6/144	8411922085198

Set 2 Tapones de Vino Luxe

Set 2 Luxe Stoppers
Jeu 2 Bouchons Luxe
2Er Set Weinverschluss Luxe
Conjunto de 2 Tampões para Vinho Luxe



- **Acero Cromado**
- **Plástico**
- Chrome Steel
- Plastic

ref.	L (cm)		Bar Code
695029	3	6/72	8411922446449

Set 2 Tapones con Émbolo

Set 2 Stoppers with Piston
Jeu 2 Bouchons à Piston
Set aus 2 Verschluss mit Kolben
Conjunto de 2 Tampões com Émbolo



- **Acero Inoxidable**
- **Silicona**
- **Plástico**
- Stainless Steel
- Silicone
- Plastic

ref.	L (cm)		Bar Code
695036	10	6/72	8411922446657

Escanciador de Vino con Tapón

Wine Pourer with Stopper
Bec Verseur de Vin avec Bouchon
Weinausschankhilfe mit Deckel
Escanciador de Vinho com Tampão



- **Acero Inoxidable**
- Stainless Steel

ref.	L (cm)		Bar Code
695020	8	6/72	8411922446357

Escanciador de Vino

Wine Pourer
Bec Verseur de Vin
Weinausschankhilfe
Escanciador de Vinho



- **Acero Inoxidable**
- Stainless Steel

ref.	L (cm)		Bar Code
695021	8	6/72	8411922446364

Escanciador Inox

Stainless Steel Pourer
Bec Verseur Inox
Edelstahl-Ausschankhilfe
Escanciador Inox



- **Acero Inoxidable 18/10**
- Stainless Steel 18/10

ref.		Bar Code
785100	6/144	8411922085174

Escanciador de Vino con Cierre

Wine Pourer with Closure
Bec Verseur de Vin avec Fermeture
Weinausschankhilfe mit Deckel
Escanciador de Vinho com Tampa



- **Acero Inoxidable**
- **Silicona**
- Stainless Steel
- Silicone

ref.	L (cm)		Bar Code
695022	10	6/72	8411922446371

Set 2 Escanciadores de Vino con Filtro

Set 2 Wine Pourers with Filter
Jeu 2 Bec Verseur avec Filtre
2Er Set Weinausschankhilfe mit Filter
Conjunto de 2 Escanciadores de Vinho com Filtro



- **Plástico**
- Plastic

ref.	L (cm)		Bar Code
695023	8,50	6/72	8411922446388

Escanciador de Vino Luxe

Luxe Wine Pourer
 Verseur de Vin Luxe
 Weinausschankhilfe Luxe
 Escanciador de Vinho Luxe

- Metal
- Silicona
- Metal
- Silicone



ref.	L (cm)		Bar Code
695024	7,50	6/72	8411922446395

Set Bomba de Vacío + Vertedor

Set Vacuum Pump + Spout
 Jeu Pompe à Vide + Verseur
 Set Dispenser + Vakuumpumpe
 Conjunto de Bomba de Vácuo + Vertedor

- Silicona
- Plástico
- Silicone
- Plastic



ref.	L (cm)		Bar Code
695025	10	6/72	8411922446401

Aireador de Vino Instantaneo

Instant Wine Aerator
 Aérateur de Vin Instantané
 Sofort Weinbelufter
 Arejador de Vinho Instantaneo

- Acero Cromado
- Plástico
- Chrome Steel
- Plastic



ref.	L (cm)		Bar Code
695027	16,50	6/72	8411922446425

Tapón Vertedor Dosificador

Dosing Pouring Stopper
 Bouchon Verseur Doseur
 Ausgießerstopfen für Spender
 Rolha para Verter com Doseador

- Plástico
- Plastic



ref.	ml		Bar Code
764006	50	6/90	8411922205756
764022	20	6/90	8411922449990

Set Sacacorchos + Descapsulador + Escanciador

Set Corkscrew + Foil Cutter + Pourer
 Jeu Tire-Bouchon + Décapsuleur + Bec Verseur
 Set Korkenzieher + Folienschneider + Ausschankhilfe
 Conjunto Saca-Rolhas + Corta Capsulas + Escanciador

- Acero Inoxidable
- Silicona
- Plástico
- Stainless Steel
- Silicone
- Plastic



ref.	L (cm)	W (cm)		Bar Code
695014	16,50	14	1/6/12	8411922446296

Tapón Vertedor Standard

Standard Pouring Stopper
Bouchon Verseur Standard
Ausgießerstopfen Standard
Rolha para Verter Standard

- **Acero Inoxidable 18/10**
- Stainless Steel 18/10



ref.		Bar Code	
764001	10/90	8411922203271	BLISTER
764011	12/240	8411922203608	

Tapón Vertedor Standard con Tapa

Standard Pouring Stopper with Lid
Bouchon Verseur Standard avec Couvercle
Ausgießerstopfen Standard mit Schutzkappe
Rolha para Verter Standard com Tampa

- **Acero Inoxidable 18/10**
- Stainless Steel 18/10



ref.		Bar Code	
764002	10/90	8411922203295	BLISTER
764012	12/240	8411922203615	

Tapón Vertedor Clásica Cónico con Tapa

Clásica Conical Pouring Stopper with Lid
Bouchon Verseur Conique Clásica avec Couvercle
Ausgießerstopfen Clásica Konischer mit Deckel
Rolha para Verter Clásica Cónica com Tampa

- **Acero Inoxidable 18/10**
- Stainless Steel 18/10



ref.		Bar Code	
759812	12/240	8411922069174	

NEW

Set 2 Tapones de Sidra

Set 2 Cider Stoppers
Jeu 2 Bouchons de Cidre
Set 3 Apfelweinverschlüsse
Jogo 2 Rolhas de Sidra

- **Plástico**
- Plastic



ref.		Bar Code	
759900	6/108/108	8411922072761	

Tapón Vertedor Standard

Standard Pouring Stopper
Bouchon Verseur Standard
Ausgießerstopfen Standard
Rolha para Verter Standard

- **Acero Cromado**
- Chrome Steel



ref.		Bar Code	
764000	10/90	8411922203257	BLISTER
764010	12/240	8411922203592	

Tapón Vertedor Clásica con Tapa

Clásica Pouring Stopper with Lid
Bouchon Verseur Clásica avec Couvercle
Ausgießerstopfen Clásica mit Deckel
Rolha para Verter Clásica com Tampa

- **Acero Inoxidable 18/10**
- Stainless Steel 18/10



ref.		Bar Code	
759801	10/90	8411922069129	BLISTER
759811	12/240	8411922069167	

Tapón Vertedor Clásica Cónico

Clásica Conical Pouring Stopper
Bouchon Verseur Conique Clásica
Ausgießerstopfen Clásica Konischer
Rolha para Verter Clásica Cónica

- **Acero Inoxidable 18/10**
- Stainless Steel 18/10



ref.		Bar Code	
759803	10/90	8411922069143	BLISTER
759813	12/240	8411922069181	

Set 2 Anillas Antigoteo

Set 2 Anti-Drip Rings
Jeu 2 Anneaux Anti-Goutte
12Er Set Anti-Tropfringen
Conjunto de 2 Anilhas Anti Gotejamento

- **Acero Inoxidable**
- Stainless Steel



ref.	Ø (cm)		Bar Code
695031	4	6/72	8411922446463

Set 12 Marcadores de Copas

Set 12 Glass Markers
Jeu 12 Marqueurs de Verres
12Er Set Glas Marker
Set 12 Identificadores de Taças



- Silicona
- Silicone

ref.	L (cm)		Bar Code
695030	14,50	6/72	8411922446456

Tapón + 6 Identificadores de Copas

Stopper + 6 Glass Identifiers
Bouchon + 6 Identifiants de Verre
Stopfen + 6 Glasmarkierer
Rolha + 6 Identificadores de Copas

- Plástico
- Silicona
- Plastic
- Silicone



ref.		Bar Code
795250	6/72	8411922440591

Aireador de Vino con Filtro

Wine Aerator with Filter
Aérateur de Vin avec Filtre
Weinbelüfter mit Filter
Arejador de Vinho com Filtro



- Acero Inoxidable
- Stainless Steel

ref.		Bar Code
784900	6/72	8411922085150

Bolas Limpia Decantador

Decanter Cleaning Balls
Billes Nettoyantes pour Décanteur
Reinigungskugeln für Dekanter
Esferas para Limpeza de Decantador

- Acero Inoxidable
- Stainless Steel



ref.	Ø (cm)		Bar Code
695035	4	6/48	8411922446500

Set 24 Etiquetas para Vino + Rotulador

Set 24 Wine Labels + Marker Pen
Jeu 24 Étiquettes de Vin + Stylo Marqueur
Set 24 Weinetiketten + Markierstift
Jogo 24 Rótulos de Vinho + Marcador

- Cartón
- Cardboard

ref.		Bar Code
785400	6/144	8411922085204



Termómetro para Botellas

Bottle Thermometer
Thermomètre pour Bouteille
Flaschenthermometer
Termometro para Garrafas

- Acero Inoxidable
- Stainless Steel



ref.	L (cm)		Bar Code
695034	6,50	6/72	8411922446494

Enfriador para Botellas Black

Black Bottle Cooler
Refroidisseur de Bouteilles Black
Flaschenkühler Schwarz
Arrefecedor de Garrafas Preto

- Nylon
- Gel Refrigerante
- Nylon
- Cooling Gel



ref.	W (cm)	H (cm)		Bar Code
786050	15,50	23	6/24	8411922449914

Enfriador para Latas Black

Can Cooler Black
 Refroidisseur de Boîtes Black
 Dosenkühler Schwarz
 Arrefecedor de Latas Preto

- Plástico
- Gel Refrigerante
- Plastic
- Cooling Gel



ref.	L (cm)	H (cm)		Bar Code
786075	26	11	6/48	8411922456264

Bolsa Enfriabotellas 4 Lados

4 Sided Bottle Cooler
 Sac Refroidisseur de Bouteilles 4 Côtés
 4-Seitige Kühltasche für Flaschen
 Saco de Refrigeração para Garrafas 4 lados

- Gel Refrigerante
- Cooling Gel



ref.	L (cm)	W (cm)		Bar Code
778450	25	10	12/48	8411922090352

Bolsa Enfriador para Botellas

Bottle Cooling Bag
 Sac Refroidisseur de Bouteilles
 Kühltasche für Flaschen
 Saco de Refrigeração para Garrafas

- PVC
- Reutilizable
- PVC
- Reusable



ref.	L (cm)	W (cm)	H (cm)		Bar Code
739801	11	11	26	12/72	8411922441864

Enfriador Confort

Confort Bottle Cooler
 Rafraîchisseur de Bouteilles Confort
 Flaschenkühler Confort
 Arrefecedor de Garrafas Confort

- Plástico
- Gel Refrigerante
- Plastic
- Cooling Gel

ref.	L (cm)	W (cm)		Bar Code
695042	21	15	1/6	8411922451818

Enfriador para Botellas

Bottle Cooler
 Refroidisseur de Bouteilles
 Flaschenkühler
 Arrefecedor de Garrafas

- Plástico
- Gel Refrigerante
- Plastic
- Cooling Gel



ref.	L (cm)	W (cm)		Bar Code
786000	38	16	6/24	8411922085280

Bolsa Enfriabotellas Luxe 2 Lados

Luxe 2 Sided Bottle Cooler
 Sac Refroidisseur de Bouteilles Luxe 2 Côtés
 2-Seitige Kühltasche für Flaschen Luxe
 Saco de Refrigeração para Garrafas Luxe 2 Lados

- Gel Refrigerante
- Cooling Gel



ref.	L (cm)	W (cm)		Bar Code
778400	25	10	12/72	8411922080940

Gel Repuesto Enfriador de Botellas Confort

Confort Bottle Cooler Refill Gel
 Gel de Replacement Rafraîchisseur de Bouteilles Confort
 Ersatz-Gel für Flaschenkühler Confort
 Recarga de Gel para Arrefecedor de Garrafas Confort

- PP
- Gel Refrigerante
- Reutilizable
- PP
- Cooling Gel
- Reusable



ref.	W (cm)	H (cm)		Bar Code
695046	14	18,50	6/24	8411922457858



Enfriabotellas Doble Pared

Double-wall Bottle Cooler
 Refroidisseur de Bouteilles Double Paroi
 Doppelwand-Flaschenkühler
 Arrefecedor de Garrafas de Parede Dupla



- **Acero Inoxidable**
- Stainless Steel

ref.	Ø (cm)	H (cm)		Bar Code
786100	11,50	20	4/12	8411922086072

Champanera Versailles

Versailles Champagne Bucket
 Rafräichisseur à Champagne Versailles
 Champagnerkühler Versailles
 Champanheira Versailles



- **Acero Inoxidable**
- **Apilable**
- Stainless Steel
- Stackable

ref.	Ø (cm)	H (cm)		Bar Code
700700	19	21	1/6	8411922453065

Cubo para Champán

Champagne Bucket
 Seau Champagne
 Champagner Eimer
 Balde para Champanhe



- **Acero Inoxidable**
- Stainless Steel

ref.	Lts	Ø (cm)		Bar Code
711320	5	20	4	8411922622249

Cubitera Clásica

Clásica Ice Bucket
 Seau à Glace Clásica
 Eiskübel Clásica
 Balde de Gelo Clásica



- **Acero Inoxidable**
- Stainless Steel

ref.	Lts	Ø (cm)		Bar Code
711414	1,30	14	1/6/48	8411922622256

Cubo Mini

Mini Bucket
 Seau Mini
 Eimer Mini
 Balde Mini



- **Acero Inoxidable**
- Stainless Steel

ref.	Ø (cm)	H (cm)		Bar Code
711807	7	7	6/72	8411922434057
711809	9	8,50	6/72	8411922434064
711810	10	10	6/72	8411922434071

Cubo Inox

Stainless Steel Bucket
 Seau Inox
 Edelstahl Eimer
 Balde Inox



- **Acero Inoxidable**
- Stainless Steel

ref.	Ø (cm)	Lts		Bar Code
711812	12	1	6/48	8411922203882
711816	16	1,90	6/24	8411922622348
711820	20	3,80	6/18	8411922622355
711826	26	8,50	6/12	8411922622362

Exprimidor Manual

Manual Juicer
 Presse-Agrumes Manuel
 Manuelle Saftpresse
 Espremedor Manual



- **PP**
- PP

ref.	L (cm)		Bar Code
780900	18	1/6/72	8411922082432

Exprimidor

Juicer
 Presse-Agrumes
 Saftpresse
 Espremedor



- **Madera de Haya**
- **Revestimiento de Aceite**
- Beech Wood
- Oil Coating

ref.	L (cm)		Bar Code
747940	16	6/36	8411922453638

Exprimidor para Limas y Limones Mini

Mini Lime and Lemon Juicer
 Presse-Agrumes de Citrons Verts et Citrons Mini
 Mini-Entsafter für Limetten und Zitronen
 Espremedor de Lima e Limão Mini

- Plástico
- Plastic



ref.	Ø (cm)	H (cm)	📦	Bar Code
793600	7	8	12/24	8411922092615

Coctelera Boston

Boston Cocktail Shaker
 Shaker Boston
 Cocktail Shaker Boston
 Shaker para Cocktail Boston



- Acero Inoxidable
- Vidrio
- Stainless Steel
- Glass

ref.	Lts	📦	Bar Code
727300	0,50	1/6/12	8411922084368

Vaso Coctelera Boston

Boston Shaker Glass
 Verre Shaker Boston
 Glas für Boston Cocktail Shaker Boston
 Copo de Shaker para Cocktail Boston



- Vidrio
- Glass

ref.	Lts	📦	Bar Code
727350	0,50	1/6/24	8411922084375

Coctelera Clásica

Clásica Cocktail Shaker
 Shaker Clásica
 Cocktail Shaker Clásica
 Shaker para Cocktail Clásica



- Acero Inoxidable 18/10
- Stainless Steel 18/10

ref.	Lts	📦	Bar Code
769100	0,70	1/6/24	8411922209464

Colador Cocktail

Cocktail Strainer
 Passoire pour Cocktail
 Cocktail-Sieb
 Coador de Cocktails



- Acero Inoxidable
- Stainless Steel

ref.	L (cm)	W (cm)	📦	Bar Code
745200	15	12	6/96	8411922436549

Cucharilla Cocktail

Cocktail Spoon
 Cuillère Cocktail
 Cocktail -Teelöffel
 Colher Coquetel



- Acero Inoxidable
- Stainless Steel

ref.	L (cm)	📦	Bar Code
733700	25	6	8411922087048

Cucharilla Cocktail con Macerador

Cocktail Spoon with Mudler
 Cuillère Cocktail avec Pilon
 Cocktail -Teelöffel mit Rührer
 Colher Coquetel com Pico



- Acero Inoxidable
- Stainless Steel

ref.	L (cm)	📦	Bar Code
733750	25	6/96	8411922435078

Macerador para Cocktails

Cocktail Mudler
Pilon à Cocktail
Cocktail Rührer
Pico para Cocktails

- **Acero Inoxidable**
- **Plástico**
- **TPR**
- Stainless Steel
- Plastic
- TPR



ref.	L (cm)		Bar Code
781000	21	1/6/72	8411922082449

Macerador para Cocktails de Madera

Wooden Cocktail Mudler
Pilon à Cocktails en Bois
Cocktail Stößel aus Holz
Pico para Cocktails de Madeira

- **Madera de Haya**
- Beech Wood



ref.	L (cm)		Bar Code
683300	25	6/72	8411922456981

Medidor de Licor Doble 30+20ml

Double Spirit Measurer 30+20ml
Mesureur de Liqueur Double 30+20ml
Doppelter Likör-Messbecher 30+20ml
Medidor de Licor Duplo 30+20ml



- **Acero Inoxidable**
- Stainless Steel

ref.	ml		Bar Code
795100	30+20	12/144	8411922093605

Medidor de Licor Doble 50+25ml

Spirit Double Measurer 50+25ml
Double Mesureur de Liqueur 50+25ml
Doppeltes Likör-Messgerät 50+25ml
Medidor de Licor Duplo 50+25ml



- **Acero Inoxidable**
- Stainless Steel

ref.	ml		Bar Code
747100	25-50	6/120	8411922437454

Medidor de Licor Regulable

Adjustable Spirit Measurer
Mesureur de Liqueur Réglable
Einstellbarer Likörmesser
Medidor de Licor Ajustável



- **Plástico**
- **Regulable**
- Plastic
- Adjustable

ref.	H (cm)	Cts		Bar Code
791700	11	4,50	6/30	8411922090864

Vaso Medidor Mini

Mini Measuring Cup
Verre Mesureur Mini
Mini-Messbecher
Copo de Medição Mini



- **Vidrio**
- Glass

ref.	H (cm)	Ø (cm)		Bar Code
744800	6	5	6/72	8411922436495

Medidor de Licor Triple

Triple Spirit Measurer
Mesureur de Liqueur Triple
Dreifacher Likörmesser
Medidor de Licor Triplo

- **Acero Inoxidable**
- Stainless Steel

ref.	L (cm)		Bar Code
791600	11	6/72	8411922090857



Bandeja para Cubitos de Hielo con Tapa

Ice Cubes Tray with Lid
Plateau à Glaçons avec Couvercle
Eiswürfelbehälter mit Deckel
Bandeja de Cubos de Gelo com Tampa



- **Silicona**
- **Evita el derrame y la absorción de olores**
- **Fácil desmoldeo**
- **Cubitos 33x33x33mm**
- Silicone
- Prevents from spilling and absorbing freezer smells
- Easy to release
- Cubes 33x33x33mm



230°C/-60°C

ref.	L (cm)	W (cm)	📦	Bar Code	
860609	13	13	1/6/36	8411922449198	9 CUBITOS/CUBES
860621	21	14	1/6/30	8411922449204	21 CUBITOS/CUBES

Molde para Hielos Cuadrados XL

Square Ice Cubes Mold XL
Moule pour Glaçon Carré XL
Quadratische Eisform XL
Molde de Gelos Quadrados XL



- **Silicona**
- Silicone



230°C/-60°C

ref.	L (cm)	W (cm)	H (cm)	📦	Bar Code
870650	16	11	5	6/36	8411922093797

Molde 8 Hielos Cuadrados XL

Square 8 Ice Cube Tray XL
Moule 8 Glaçons Carrés XL
Form für 8 Viereckige Eiswürfel XL
Molde 8 para Cubos de Gelo XL



- **Silicona**
- Silicone



230°C/-60°C

ref.	L (cm)	W (cm)	H (cm)	📦	Bar Code
870660	21,50	11,50	5	6/36	8411922474251

Set 2 Moldes para Hielo

Set 2 Ice Trays
Jeu 2 Moules pour Glaçons
Set 2 Eisformen
Jogo 2 Moldes de Gelo



- **Silicona**
- Silicone



220°C/-20°C

ref.	L (cm)	W (cm)	📦	Bar Code
870600	25	12	6/24	8411922086232

Bandeja para Minihielos

Mini Ice Tray
Mini-Moule à Glace
Mini-Eiswürfel-Form
Bandeja para Gelo Mini



- **Silicona**
- Silicone



230°C/-60°C

ref.	L (cm)	W (cm)	📦	Bar Code
685500	24	12	6/36	8411922458466

Molde 4 Bolas de Hielo XL

4 Ice Ball Mold XL
Moules pour 4 Boules Glace XL
Form 4 Eiskugeln XL
Molde 4 Bolas de Gelo XL

- **Silicona**
- Silicone



230°C/-60°C



ref.	∅ (cm)	L (cm)	W (cm)	📦	Bar Code
765950	5	12	12	12/48	8411922454826

Molde Bolas de Hielo Gintonic's XL (4 uds.)

Gintonic's Ice Ball Mold XL (4 pcs)
Moule Boule de Glaçon Gintonic's XL (4 pcs)
Gintonic's Eiskugelform XL (4 stk.)
Forma Bolas de Gelo Gintonic's XL (4 uds.)

- **Silicona**
- **Plástico**
- **Líquido frío durante mucho más tiempo**
- Silicone
- Plastic
- Cold liquid for much longer



ref.	∅ (cm)	📦	Bar Code
870500	5,50	6/72	8411922086089



Molde Bolas de Hielo Gintonic's XXL (2 uds.)

Gintonic's Ice Ball Mold XXL (2 pcs)
Moule Boule de Glaçon Gintonic's XXL (2 pcs)
Gintonic's Eiskugelform XXL (2 stk.)
Forma Bolas de Gelo Gintonic's XXL (2 uds.)

- **Silicona**
- **Plástico**
- **Líquido frío durante mucho más tiempo**
- Silicone
- Plastic
- Cold liquid for much longer



ref.	∅ (cm)	📦	Bar Code
870550	7,50	6/48	8411922090543



Picador para Hielo

Ice Crusher
Broyeur à Glace
Eiszerkleinerer
Triturador de Gelo



- **Plástico**
- **Acero Inoxidable**
- Plastic
- Stainless Steel

ref.	∅ (cm)	H (cm)		Bar Code
792400	16	26	1/6	8411922091977

Sifón de Soda

Soda Siphon
Siphon à Soda
Soda-Siphon
Sifão de Refrigerante



- **Aluminio**
- Aluminium

ref.	Lts		Bar Code
744010	0,80	1/2/12	8411922436242

Cargas de Sifón de Soda CO2

CO2 Cartridges for Soda Siphon
Charges CO2 pour Siphon à Soda
Soda-Siphon CO2-Ladungen
Cargas de Sifão de Refrigerante CO2



ref.		Bar Code
744100	1/5/30	8411922436259

Abrechapas Soft Touch Color

Soft Touch Bottle Opener Color
Ouvre-Bouteilles Soft Touch Couleur
Soft-Touch-Kapselheber Farbe
Abre garrafas Soft Touch Cor



surtido/assorted 6+6+6+6=24

- **Plástico**
- **Metálico**
- Plastic
- Metallic

ref.	L (cm)	W (cm)		Bar Code
752600	13	4,50	24/120	8411922445022

Abrechapas Inox

Stainless Steel Bottle Opener
Ouvre-Bouteilles Inox
Flaschenöffner aus Edelstahl
Abridor de Garrafas Inox



- **Acero Inoxidable**
- Stainless Steel

ref.	L (cm)		Bar Code
695037	18	6/72	8411922446524

Abrechapas Soft Touch

Soft Touch Bottle Opener
Ouvre-Bouteilles Soft Touch
Flaschenöffner Soft Touch
Abridor de Garrafas Soft Touch



- **Acero Inoxidable**
- **Plástico**
- Stainless Steel
- Plastic

ref.	L (cm)		Bar Code
695038	13	6/72	8411922446531

Abrelatas Palomilla

Manual Can Opener
Ouvre-Boîte Papillon
Flügeldosenöffner
Abre-Latas Manual



- Acero Inoxidable
- Stainless Steel

ref.	L (cm)	W (cm)		Bar Code
743100	7,60	4,20	6/108	8411922456479

Abrelatas Explorador (2 uds.)

Explorer Can Opener (2 pcs)
Ouvre-Boîtes Explorateur (2 pcs)
Entdecker Dosenöffner (2 stk.)
Abre-Latas Explorador (2 uds.)



- Acero Inoxidable
- Stainless Steel

ref.		Bar Code
785500	12/144	8411922085211

Abrelatas Mariposa

Butterfly Can Opener
Ouvre-Boîtes Papillon
Schmetterling-Dosenöffner
Abre-Latas Borboleta



- Metálico
- Metallic

ref.	L (cm)	W (cm)		Bar Code
785250	7	5	6/144	8411922452754

Abrelatas Mariposa + Descapsulador Curvo

Butterfly Can Opener + Curved Bottle Opener
Ouvre-Boîtes Papillon + Ouvre-Bouteilles Courbe
Schmetterling-Dosenöffner + Gebogener Kapselöffner
Abre-latas Borboleta + Abre-Garrafas Curvo



- Níquel
- Nickel

ref.		Bar Code
785600	12/144	8411922085228

NEW

Set 2 Descapsuladores Curvos

Set of 2 Curved Bottle Opener
Set de 2 Décapsuleur Courbés
Set 2 Gebogene Flaschenöffner
Conjunto 2 Abridores Curvos



- Acero Inoxidable
- Stainless Steel

ref.	L (cm)	W (cm)	H (cm)		Bar Code
666700	9	1,90	0,90	12/192	8411922475135

Descapsulador Plano (2 uds.)

Flat Bottle Opener (2 pcs)
Ouvre-Bouteilles Plat (2 pcs)
Flacher Kapselöffner (2 stk.)
Abre-Garrafas plano (2 uds.)



- Acero Inoxidable
- Stainless Steel

ref.		Bar Code
785700	12/144	8411922085235

Accesorios.

Rociador de Salsas

Sauce Sprayer
Poire à Sauces
Soßenspritze
Pulverizador de Molho



- Acero Inoxidable 18/10
- Silicona
- Stainless Steel 18/10
- Silicone

ref.	L (cm)		Bar Code
777510	26	6/48	8411922080261

Inyector de Salsas

Sauce Injector
Injecteur de Sauces
Soßen-Injektor
Injetor de Molho



- Acero Inoxidable
- Plástico
- Stainless Steel
- Plastic

ref.	L (cm)		Bar Code
777500	23	6/48	8411922080254

Pipeta para Salsas

Sauce Pipette
Pipette pour Sauces
Saucen-Pipette
Pipeta para Molhos

- Silicona
- Plástico
- Silicone
- Plastic

ref.	L (cm)	ml		Bar Code
777910	32,50	22	6/36	8411922470635



Asador Portaespecies para Pollo

Chicken Roast Stand with Infuser
Rôtissoire Porte-Épices à Poulet
Hähnchengriller mit Aromabehälter
Assador Porta-Especiarias para Frango

- Acero Inoxidable
- Incluye Receta
- Stainless Steel
- Includes Recipe



ref.	L (cm)	W (cm)		Bar Code
731400	15	12	1/6/12	8411922086119

Set 5 Bolsas para Asar Desechables

Set of 5 Disposable Roasting Bags
Jeu de 5 Sacs à Rôtir Jetables
Set 5 Einweg-Grilltaschen
Jogo 5 Sacos de Grelhar Descartáveis

- Plástico
- Plastic



ref.	L (cm)	W (cm)		Bar Code
753700	38	25	12/48	8411922085099

Bolsas para Grill Tostadora

Toaster Grill Bags
 Sacs pour Grille Pain
 Toaster-Grill-Taschen
 Sacos para Grelhador Torradeira

- PTFE
- PTFE



ref.	L (cm)	W (cm)	📦	Bar Code
778900	24,50	17,50	24	8411922081190



Pico Vertedor Adaptable

Slip-On Pot Spout
 Bec Verseur Adaptable
 Aufsteckbarer Topf Ausguss
 Bico Vertedor Adaptável

- **Silicona**
- Silicene



ref.	L (cm)	📦	Bar Code
733600	11,50	6/96	8411922086874

Ablandador de Carne

Meat Tenderizer
 Attendrisseur de Viande
 Fleischklopfel
 Amaciante de Carne

- **Acero Inoxidable**
- Stainless Steel



ref.	📦	Bar Code
728200	6/48	8411922084955

Placa para Descongelar Alimentos

Plate for Defrosting Food
 Plaque pour Décongeler des Aliments
 Auftauplatte für Gefriergut
 Placa para Descongelar Alimentos

- **Aluminio**
- **Silicona**
- **Plástico**
- **Reduce el tiempo de descongelación**
- **Bandeja para recoger el agua**
- Aluminium
- Silicone
- Plastic
- Reduces defrosting time
- Lower tray to collect the water

ref.	L (cm)	W (cm)	📦	Bar Code
724450	33,50	23,50	6	8411922455373



Lupa para Frigorífico

Magnifying Glass for Fridge
Loupe pour Réfrigérateur
Lupe für Kühlschrank
Lupa para Frigorífico

- **Plástico**
- **Ayuda a leer instrucciones, recetas, ingredientes, fechas de caducidad...**
- **Aumento x2**
- **Con imán y luz**
- Plastic
- It helps you reading instructions, recipes, ingredients, dates of expiry...
- Magnification x2
- With magnet and light



ref.	L (cm)	Ø (cm)	📦	Bar Code
708800	18,50	8	6/36	8411922441406



Dispensador para Agua

Water Dispenser
Distributeur d'Eau
Wasserspender
Dispensador de Agua

- **Plástico**
- **Acero Inoxidable**
- **Con solo un toque**
- **Incluye cable USB de carga**
- Plastic
- Stainless Steel
- Just one touch
- Includes charging USB cable

ref.	Ø (cm)	H (cm)	📦	Bar Code
723650	7,20	13	1/6/24	8411922455366



Prensasaltas

Can Crusher
Compacteur de Boîtes
Dosenpresse
Prensa de Latas

- **Acero**
- Steel

ref.	📦	Bar Code
777400	1/6/12	8411922080247



Encendedor de Gas Colorful

Colourful Gas Lighter
Allume Gaz Colorful
Taschenfeuerzeug für Gas Colorful
Isqueiro a Gás Colorful

- **Plástico**
- **Metálico**
- **Recargable**
- **Contiene gas**
- Plastic
- Metallic
- Rechargeable
- Contains gas

ref.	L (cm)		Bar Code
772250	27	12/72	8411922471281



Encendedor de Gas Flexible Silver

Silver Flexible Gas Lighter
Allume Gaz Flexible Silver
Taschenfeuerzeug für Gas Flexible Silver
Isqueiro a Gás Flexível Silver

- **Plástico**
- **Acero Inoxidable**
- **Recargable**
- **Contiene gas**
- Plastic
- Stainless Steel
- Rechargeable
- Contains gas

ref.	L (cm)		Bar Code
772260	24	12/72	8411922471298



Encendedor Eco

Eco Lighter
Allume Gaz Eco
Feuerzeug Eko
Isqueiro Eco

- **Plástico**
- **Metálico**
- **Contiene gas**
- ***Solo continente**
- Plastic
- Metallic
- Contains gas
- *Only mainland

ref.	L (cm)		Bar Code
772100	18	6/24	8411922078015



Manopla Reforzada

Reinforced Oven Glove
Gant de Four Renforcé
Verstärkter Topfhandschuh
Manopla Reforçada



- Algodón
- Poliéster
- Cotton
- Polyester

ref.	L (cm)	W (cm)		Bar Code
706850	32	20	6/48	8411922452082

Pinchos para Caracoles

Skewers for Snails
Piques à Escargots
Gabeln für Schnecken
Garfos para Caracóis

- Acero Inoxidable
- Stainless Steel

ref.	L (cm)		Bar Code
687000	11	6/300	8411922459579

NEW

Manopla Silicona

Silicone Oven Glove
Gant de Cuisine en Silicone
Silikon-Topflappen
Luva de Silicone



- Silicona
- Silicone

ref.	L (cm)	W (cm)		Bar Code
765810	33,50	18,50	6/36	8411922470628

Pinchos para Caracoles



NEW

Set 2 Manoplas de Silicona

Set of 2 Silicone Oven Mitts
Set de 2 Gant Silicone
Set 2 Silikonhandschuhe
Conjunto de 2 Manoplas de Silicone

- Silicona
- Silicone

ref.	L (cm)	W (cm)		Bar Code
691600	8,50	9	6/96	8411922475760





Cazuelita Raciones

Casserole for Side Dishes
Cassolette Portions
Serviertöpfchen Gastrodessin
Mini Caçarola para Rações

ref.	∅ (cm)	H (cm)	∩	Bar Code
942006	14	4,50	6	8411922459401



Plato para Hamburguesa

Hamburger Plate
Plat à Hamburger
Burgerteller
Prato para Hambúrguer

ref.	∅ (cm)	H (cm)	∩	Bar Code
942005	22	2,30	6	8411922459395



Bandeja Redonda para Aves-Carne

Round Tray for Meat-Poultry
Plateau à Volaille-Viande Rond
Rundes Geflügel-Fleisch-Tablett
Bandeja Redonda para Aves-Carne

ref.	∅ (cm)	H (cm)	∩	Bar Code
942004	28	2,50	6	8411922459388



Plato para Postre

Dessert Plate
Plat à Desserts
Dessertteller
Prato de Sobremesa

ref.	∅ (cm)	H (cm)	∩	Bar Code
942000	18	1,70	6	8411922459340



Bandeja para Verduras

Oval Tray for Vegetables
 Plateau à Légumes Ovale
 Ovale Gemüseblett
 Bandeja Oval para Legumes

ref.	L (cm)	W (cm)	H (cm)		Bar Code
942002	35	24	3	6	8411922459364



Bandeja Redonda para Marisco

Round Tray for Seafood
 Plateau à Fruits de Mer Rond
 Rundes Tablett für Meeresfrüchte
 Bandeja Redonda para Marisco

ref.	∅ (cm)	H (cm)		Bar Code
942003	28	2,50	6	8411922459371



Bandeja para Pescado Oval

Oval Fish Tray
 Plateau à Poisson Ovale
 Ovale Fischtblett
 Bandeja Oval para Peixe

ref.	L (cm)	W (cm)	H (cm)		Bar Code
942001	35	24	3	6	8411922459357



Esmaltado Vintage.

Musgo.

ACERO ESMALTADO VITRIFICADO

VITRIFIED ENAMELED STEEL

ACIER ÉMAILLÉ VITRIFIÉ

KERAMISCH EMAILLIERTER STAHL

AÇO ESMALTADO VITRIFICADO



Pote Vintage

Vintage Mug

Tasse Vintage

Tasse Vintage

Caneca Vintage



ref.	∅ (cm)	Lts	∩	Bar Code
935208	8	0,40	6	8411922457483

Plato Hondo Vintage

Vintage Soup Plate

Assiette Creuse Vintage

Tiefer Teller Vintage

Prato Fundo Vintage



ref.	∅ (cm)	H (cm)	∩	Bar Code
936722	22	4	6	8411922457650
936724	24	4	6	8411922457667
936728	28	4	6	8411922457674

Bol Vintage

Vintage Bowl

Bol Vintage

Schale Vintage

Tigela Vintage



ref.	∅ (cm)	H (cm)	∩	Bar Code
936212	12	7	12	8411922457599
936214	14	8,50	12	8411922457605

Plato de Huevos Vintage

Vintage Egg Dish

Plat à Oeuf Vintage

Eierteller Vintage

Prato para Ovos Vintage



ref.	∅ (cm)	∩	Bar Code
936114	14	6	8411922457582

Plato Llano Vintage

Vintage Plain Dish

Assiette Plate Vintage

Flache Teller Vintage

Prato Raso Vintage



ref.	∅ (cm)	H (cm)	∩	Bar Code
935122	22	2,30	6	8411922457445
935124	24	2,50	6	8411922457452
935126	26	2,50	6	8411922457469
935128	28	2,50	6	8411922457476

Bandeja Vintage

Vintage Platter

Plat Vintage

Tablett Vintage

Bandeja Vintage



ref.	L (cm)	W (cm)	∩	Bar Code
935930	30	20	6	8411922457551
935935	35	24	6	8411922457568

Bol con Pie Vintage

Vintage Bowl with Stand

Bol avec Pied Vintage

Schale mit Fuß Vintage

Tigela com Pé Vintage



ref.	∅ (cm)	H (cm)	∩	Bar Code
935812	12	8	12	8411922457544

Cazo Vintage

Vintage Saucepan

Casserole Vintage

Stielkasserolle Vintage

Caçarola Vintage



ref.	∅ (cm)	∩	Bar Code
936012	12	6	8411922457575

Lechera Vintage

Vintage Milk Churn
Bidon à Lait Vintage
Milchkanne Vintage
Leiteira Vintage



ref.	∅ (cm)	H (cm)	Lts		Bar Code
935010	10	22	1	6	8411922457438

Cubo Vintage 11cm

Vintage Utility Pail / Bucket 11cm
Seau Vintage 11cm
Eimer Vintage 11cm
Balde com Asa Vintage 11cm



ref.	∅ (cm)	H (cm)	Lts		Bar Code
935511	11	11	0,72	6	8411922458848

Cubo Vintage 14cm

Vintage Utility Pail / Bucket 14cm
Seau Vintage 14cm
Eimer Vintage 14cm
Balde com Asa Vintage 14cm



ref.	∅ (cm)	Lts		Bar Code
935514	14	1,50	6	8411922457513

Escurridera Vintage

Vintage Colander
Égouttoir Vintage
Sieb Vintage
Escorredor Vintage



ref.	∅ (cm)		Bar Code
936422	22	6	8411922457629

Cacillo Vintage

Vintage Ladle
Louche Vintage
Schöpfkelle Vintage
Concha Vintage



ref.	∅ (cm)	L (cm)		Bar Code
936509	9	36	12	8411922457636

Espumadera Vintage

Vintage Skimmer
Ecumoire Vintage
Schaumlöffel Vintage
Escumadeira Vintage



ref.	∅ (cm)	L (cm)		Bar Code
936610	10	36	12	8411922457643

Palangana Vintage

Vintage Wash Bowl
Cuvette Vintage
Waschschüssel Vintage
Bacia Vintage



ref.	∅ (cm)	H (cm)	Lts		Bar Code
935332	32	10	3,60	6	8411922457490

Jarra Bombada Vintage

Vintage Belly Shape Pitcher
Jarre Bombée Vintage
Gebogene Form Krug Vintage
Jarro Arredondado Vintage



ref.	H (cm)	Lts		Bar Code
935625	25	2,50	6	8411922457520

Orinal Vintage

Vintage Chamber Pot
Pot de Chambre Vintage
Töpfchen Vintage
Bacio Vintage



ref.	∅ (cm)	Lts		Bar Code
935724	24	3,50	6	8411922457537

Cafetera Cónica Vintage

Vintage Conical Coffee Pot
Cafetière Conique Vintage
Konische Kaffeekanne Vintage
Cafeteira Conica Vintage



ref.	Lts		Bar Code
935410	1	6	8411922457506

Pote Vintage

Vintage Mug
Tasse Vintage
Tasse Vintage
Caneca Vintage



ref.	∅ (cm)	Lts	📦	Bar Code
918508	8	0,40	12	8411922204599

Palangana Vintage

Vintage Wash Bowl
Cuvette Vintage
Waschschüssel Vintage
Bacia Vintage



ref.	∅ (cm)	Lts	📦	Bar Code
918632	32	3,60	6	8411922204605

Orinal Vintage

Vintage Chamber Pot
Pot de Chambre Vintage
Töpfchen Vintage
Bacio Vintage



ref.	∅ (cm)	Lts	📦	Bar Code
919322	22	2,70	6	8411922204674

Jarra Bombada Vintage

Vintage Belly Shape Pitcher
Jarre Bombée Vintage
Gebogene Form Krug Vintage
Jarro Arredondado Vintage



ref.	Lts	📦	Bar Code
919225	2,50	6	8411922204667

Cafetera Cónica Vintage

Vintage Conical Coffee Pot
Cafetière Conique Vintage
Konische Kaffeekanne Vintage
Cafeteira Conica Vintage



ref.	Lts	📦	Bar Code
918710	1	6	8411922204612

Tetera Vintage

Vintage Teapot
Théière Vintage
Teekanne Vintage
Chaleira Vintage



ref.	Lts	📦	Bar Code
918807	0,70	6	8411922204629





Pote Vintage

Vintage Mug
Tasse Vintage
Tasse Vintage
Caneca Vintage



ref.	∅ (cm)	Lts	📦	Bar Code
911006	6	0,175	12	8411922009064
911008	8	0,40	12	8411922009088
911010	10	0,70	12	8411922009101

Plato de Huevos Vintage

Vintage Egg Dish
Plat à Oeuf Vintage
Eierteller Vintage
Prato para Ovos Vintage



ref.	∅ (cm)	Lts	📦	Bar Code
912214	14	0,40	12	8411922061147
912218	18	0,90	12	8411922204933

Cubo Vintage

Vintage Utility Pail / Bucket
Seau Vintage
Eimer Vintage
Balde com Asa Vintage



ref.	∅ (cm)	Lts	📦	Bar Code
911514	14	1,50	6	8411922034141
911522	22	5,50	6	8411922034226

Azucarero con Tapa Vintage

Vintage Sugar Bowl with Lid
Sucrier avec Couvercle Vintage
Zuckerdose mit Deckel Vintage
Açucareiro com Tampa Vintage



ref.	Lts	📦	Bar Code
910650	0,50	6	8411922006506

Cafetera Cónica Vintage

Vintage Conical Coffee Pot
Cafetière Conique Vintage
Konische Kaffeekanne Vintage
Cafeteira Conica Vintage



ref.	Lts	📦	Bar Code
910210	1	6	8411922002102
910250	0,50	6	8411922002508

Cafetera Turca Vintage

Vintage Turkish Coffee Pot
Cafetière Turque Vintage
Türkische Kaffeekanne Vintage
Cafeteira Turca Vintage



ref.	Lts	📦	Bar Code
910103	0,35	6	8411922087796
910145	0,50	6	8411922001501

Tetera Vintage

Vintage Teapot
Théière Vintage
Teekanne Vintage
Chaleira Vintage



ref.	Lts	📦	Bar Code
910350	0,50	6	8411922003505
910370	0,75	6	8411922003758

Cafetera con Filtro Vintage

Vintage Coffee Pot with Filter
Cafetière avec Filtre Vintage
Filterkaffeekanne Vintage
Cafeteira com Filtro Vintage



ref.	Lts	📦	Bar Code
910815	1,50	4	8411922008159

Lechera de Servir Vintage

Vintage Milk Pitcher
Pot à Lait à Servir Vintage
Milchkännchen Vintage
Leiteira Vintage



ref.	Lts	📦	Bar Code
910550	0,50	6	8411922005509

Cafetera Pava Vintage

Vintage Kettle
Bouilloire Vintage
Wasserkessel Vintage
Chaleira Vintage



ref.	Lts	📦	Bar Code
910410	1	6	8411922004106

Esmaltado Vintage.

Bordeaux.

ACERO ESMALTADO VITRIFICADO

VITRIFIED ENAMELED STEEL

ACIER ÉMAILLÉ VITRIFIÉ

KERAMISCH EMAILLIERTER STAHL

AÇO ESMALTADO VITRIFICADO



hand
made

Pote Vintage

Vintage Mug

Tasse Vintage

Tasse Vintage

Caneca Vintage



ref.	Ø (cm)	H (cm)	📦	Bar Code
909407	7	0,30	6	8411922438178
909408	8	0,40	12	8411922438185

Plato Llano Vintage

Vintage Plain Dish

Assiette Plate Vintage

Flache Teller Vintage

Prato Raso Vintage



ref.	Ø (cm)	H (cm)	📦	Bar Code
908118	18	1,70	6	8411922441147
908120	20	2	6	8411922460032
908122	22	2,30	6	8411922437966
908124	24	2,50	6	8411922437973
908126	26	2,50	6	8411922437980
908128	28	2,50	6	8411922437997

Plato Hondo Vintage

Vintage Soup Plate

Assiette Creuse Vintage

Tiefer Teller Vintage

Prato Fundo Vintage



ref.	Ø (cm)	H (cm)	📦	Bar Code
908022	22	4	6	8411922437928
908024	24	4	6	8411922437935
908028	28	4	6	8411922437942
908032	32	4	6	8411922437959

Platillo Vintage

Vintage Plate

Assiette Vintage

Unterteller Vintage

Prato Vintage



ref.	Ø (cm)	📦	Bar Code
907512	12	12	8411922447279
907514	14	12	8411922447286

Bandeja Ovalada Vintage

Vintage Oval Platter

Plat Ovale Vintage

Ovales Tablett Vintage

Bandeja Oval Vintage



ref.	L (cm)	📦	Bar Code
908725	25	6	8411922438086
908730	30	6	8411922438093
908736	36	6	8411922438109

Bol Vintage

Vintage Bowl

Bol Vintage

Schale Vintage

Tigela Vintage



ref.	Ø (cm)	H (cm)	📦	Bar Code
908312	12	7	12	8411922438017
908314	14	8,50	12	8411922438024
908316	16	9	12	8411922438031
908320	20	11,50	12	8411922438048

Bol con Asa Vintage

Vintage Bowl with Handle
Bol avec Anse Vintage
Schale mit Henkel Vintage
Tigela com Pega Vintage



ref.	∅ (cm)	📦	Bar Code
909114	14	6	8411922438147

Bol con Pie Vintage

Vintage Bowl with Stand
Bol avec Pied Vintage
Schale mit Fuß Vintage
Tigela com Pé Vintage



ref.	∅ (cm)	H (cm)	📦	Bar Code
909512	12	8	12	8411922438192

Taza+Platillo Vintage

Vintage Cup + Saucer
Tasse + Petite Assiette Vintage
Tasse + Untertasse Vintage
Caneca + Prato Vintage



ref.	∅ (cm)	📦	Bar Code
908405	5-8,50	6	8411922438055

Cazo con Pico Vintage

Vintage Saucepan with Spout
Casserole avec Bec Verseur Vintage
Stielkasserolle mit Ausguss Vintage
Caçarola com Bico Vintage



ref.	∅ (cm)	📦	Bar Code
909210	10	6	8411922438161

Cubo Vintage 11cm

Vintage Utility Pail / Bucket 11cm
Seau Vintage 11cm
Eimer Vintage 11cm
Balde com Asa Vintage 11cm



ref.	∅ (cm)	H (cm)	Lts	📦	Bar Code
909311	11	11	0,72	6	8411922458831

Vaso Medidor Vintage

Vintage Measuring Jar
Verre Mesureur Vintage
Messbecher Vintage
Copo Medidor Vintage



ref.	∅ (cm)	Lts	📦	Bar Code
908612	12	1	6	8411922438079

Taza Vintage

Vintage Cup
Tasse Vintage
Tasse Vintage
Caneca Vintage



ref.	∅ (cm)	H (cm)	Lts	📦	Bar Code
907407	7	6	0,20	6	8411922447255
907408	8	6	0,26	6	8411922447262

Plato de Huevos Vintage

Vintage Egg Dish
Plat à Oeuf Vintage
Eierteller Vintage
Prato para Ovos Vintage



ref.	∅ (cm)	📦	Bar Code
909814	14	12	8411922438239
909818	18	6/12	8411922439458

Sartén Presentación Vintage

Vintage Presentation Pan
Poêle de Présentation Vintage
Präsentationpfanne Vintage
Frigideira de Apresentação Vintage



ref.	∅ (cm)	📦	Bar Code
907214	14	6	8411922456813

Olla Mini Vintage

Vintage Mini Pot
Mini Marmite Vintage
Mini Gemüsetopf Vintage
Panela Mini Vintage



ref.	∅ (cm)	Lts	📦	Bar Code
909612	12	0,50	6	8411922438215

Cubo Vintage 14cm

Vintage Utility Pail / Bucket 14cm
Seau Vintage 14cm
Eimer Vintage 14cm
Balde com Asa Vintage 14cm



ref.	∅ (cm)	Lts	📦	Bar Code
909314	14	1,50	6	8411922438154

Flanero Vintage

Vintage Cream Caramel Mold
Moule à Crème Caramel Vintage
Puddingform Vintage
Forma para Pudim Flan Vintage



ref.	∅ (cm)	H (cm)	Lts	📦	Bar Code
907108	8	6	0,25	6	8411922458060

Frutero Vintage

Vintage Fruit Bowl
Coupe à Fruits Vintage
Obstschale Vintage
Fruteira Vintage



ref.	∅ (cm)	H (cm)		Bar Code
905926	26	6	1/6	8411922454932

Escurridera Vintage

Vintage Colander
Égouttoir Vintage
Sieb Vintage
Escorredor Vintage



ref.	∅ (cm)		Bar Code
910222	22	6	8411922439434

Espumadera Vintage

Vintage Skimmer
Écumoire Vintage
Schaumlöffel Vintage
Escumadeira Vintage



ref.	∅ (cm)	L (cm)		Bar Code
909010	10	36	12	8411922438130

Cacillo Vintage

Vintage Ladle
Louche Vintage
Schöpfkelle Vintage
Concha Vintage



ref.	∅ (cm)	L (cm)		Bar Code
908906	6	25	12	8411922438208
908909	9	36	12	8411922438123

Cucharón Vintage

Vintage Serving Spoon
Cuillère Vintage
Vorlegelöffel Vintage
Colher Vintage



ref.	L (cm)		Bar Code
907800	35	6	8411922440645

Colgador de Utensilios Vintage

Vintage Wall Utensil Hanger
Crochet à Ustensiles Vintage
Utensilienaufhänger Vintage
Cabide de Utensílios Vintage



ref.	W (cm)	L (cm)		Bar Code
907700	33	47	4	8411922440973

Lechera Vintage

Vintage Milk Churn
Bidon à Lait Vintage
Milchkanne Vintage
Leiteira Vintage



ref.	∅ (cm)	H (cm)	Lts		Bar Code
913010	10	22	1	6	8411922439441

Mantequillera Vintage

Vintage Butter Dish
Beurrier Vintage
Butterdose Vintage
Manteigueira Vintage



ref.	L (cm)	W (cm)	H (cm)		Bar Code
907300	17	12	6	6	8411922449723

Fuente Honda Oval Vintage

Vintage Deep Oval Platter
Plat Ovale Profond Vintage
Tiefes Ovaletablett Vintage
Bandeja Funda Oval Vintage



ref.	L (cm)	W (cm)		Bar Code
907932	32	25,50	6	8411922440614

Rustidera con Asas Vintage

Vintage Roast Pan with Handles
Plat à Rôtir avec Anses Vintage
Bratreine mit Griffen Vintage
Tabuleiro com Asas Vintage



ref.	L (cm)	H (cm)		Bar Code
909932	32	7	6	8411922438246

Tetera Vintage

Vintage Teapot
Théière Vintage
Teekanne Vintage
Chaleira Vintage



ref.	Lts		Bar Code
908805	0,50	6	8411922438116

Palangana Vintage

Vintage Wash Bowl
Cuvette Vintage
Waschschüssel Vintage
Bacia Vintage



ref.	L (cm)	Lts		Bar Code
910132	32	3,60	6	8411922438260

Cafetera Cónica Vintage

Vintage Conical Coffee Pot
Cafetière Conique Vintage
Konische Kaffeekanne Vintage
Cafeteira Conica Vintage



ref.	Lts		Bar Code
908501	1	6	8411922438062

Orinal Vintage

Vintage Chamber Pot
Pot de Chambre Vintage
Töpfchen Vintage
Bacio Vintage



ref.	∅ (cm)	Lts		Bar Code
908224	24	3,50	6	8411922438000

Cocotte Vintage

Vintage Cocotte
Cocotte Vintage
Cocotte Vintage
Cocotte Vintage



ref.	L (cm)	W (cm)	H (cm)		Bar Code
907634	36	27	13	1	8411922441055

Esmaltado
Vintage.

Pop.

ACERO ESMALTADO VITRIFICADO
VITRIFIED ENAMELED STEEL
ACIER ÉMAILLÉ VITRIFIÉ
KERAMISCH EMAILIERTER STAHL
AÇO ESMALTADO VITRIFICADO



Pote Vintage

Vintage Mug
Tasse Vintage
Tasse Vintage
Caneca Vintage



ref.	∅ (cm)	Lts		Bar Code
925008	8	0,40	6	8411922455786

Taza Vintage

Vintage Mug
Tasse Vintage
Tasse Vintage
Caneca Vintage



ref.	∅ (cm)	Lts		Bar Code
925108	8	0,26	6	8411922455793

Cafetera Cónica Vintage

Vintage Conical Coffee Pot
Cafetière Conique Vintage
Konische Kaffeekanne Vintage
Cafeteira Conica Vintage



ref.	Lts		Bar Code
925301	1	6	8411922455816

Cubo Vintage

Vintage Utility Pail / Bucket
Seau Vintage
Eimer Vintage
Balde com Asa Vintage



ref.	∅ (cm)	Lts		Bar Code
925414	14	1,50	6	8411922455823

Cazo Vintage

Vintage Saucepan
Casserole Vintage
Stielkasserolle Vintage
Caçarola Vintage



ref.	∅ (cm)		Bar Code
925510	10	6	8411922455830

Olla Mini Vintage

Vintage Mini Pot
Mini Marmite Vintage Pot
Mini Gemüsetopf Vintage Pot
Panela Mini Vintage Pot



ref.	∅ (cm)		Bar Code
925210	10	6	8411922455809

Esmaltado Vintage.

Blanca.

ACERO ESMALTADO VITRIFICADO

VITRIFIED ENAMELED STEEL

ACIER ÉMAILLÉ VITRIFIÉ

KERAMISCH EMAILLIERTER STAHL

AÇO ESMALTADO VITRIFICADO



hand
made

Pote Vintage

Vintage Mug

Tasse Vintage

Tasse Vintage

Caneca Vintage



ref.	∅ (cm)	Lts	∅	Bar Code
903005	5	0,20	6	8411922433371
903007	7	0,30	6	8411922433388
903008	8	0,40	12	8411922204506

Plato Hondo Vintage

Vintage Soup Plate

Assiette Creuse Vintage

Tiefer Teller Vintage

Prato Fundo Vintage



ref.	∅ (cm)	∅	Bar Code
912922	22	6	8411922202472
912924	24	6	8411922204209
912928	28	6	8411922072099
912932	32	6	8411922072105
912936	36	6	8411922072112

Bandeja Ovalada Vintage

Vintage Oval Platter

Plat Ovale Vintage

Ovales Tablett Vintage

Bandeja Oval Vintage



ref.	L (cm)	W (cm)	∅	Bar Code
903925	25	17	6	8411922434569
903930	30	20	6	8411922077797
903935	35	24	6	8411922077803
903940	40	27	6	8411922077810

Plato Llano Vintage

Vintage Plain Dish

Assiette Plate Vintage

Flache Teller Vintage

Prato Raso Vintage



ref.	∅ (cm)	H (cm)	∅	Bar Code
901118	18	1,70	6	8411922441154
901120	20	2	6	8411922459876
901122	22	2,30	6	8411922434545
901124	24	2,50	6	8411922434552
901126	26	2,50	6	8411922435894
901128	28	2,50	6	8411922083460

Platillo Vintage

Vintage Plate

Assiette Vintage

Unterteller Vintage

Prato Vintage



ref.	∅ (cm)	∅	Bar Code
905608	8,50	6/36	8411922457216
905612	12	12	8411922447231
905614	14	12	8411922447248

Bol Vintage

Vintage Bowl

Bol Vintage

Schale Vintage

Tigela Vintage



ref.	∅ (cm)	H (cm)	∅	Bar Code
904212	12	7	12	8411922436167
904214	14	8,50	12	8411922436174
904216	16	9	12	8411922436181
904220	11,50	12	12	8411922436198

Bol con Asa Vertical Vintage

Vintage Bowl with Handle
Bol avec Anse Vintage
Schale mit Henkel Vintage
Tigela com Pega Vintage



ref.	∅ (cm)		Bar Code
903814	14	6/12	8411922435528

Taza+Platillo Vintage

Vintage Cup + Saucer
Tasse + Petite Assiette Vintage
Tasse + Untertasse Vintage
Caneca + Prato Vintage



ref.	∅ (cm)		Bar Code
903000	5+8,50	6	8411922437867

Plato de Huevos Vintage

Vintage Egg Dish
Plat à Oeuf Vintage
Eierteller Vintage
Prato para Ovos Vintage



ref.	∅ (cm)		Bar Code
904114	14	6	8411922433401
904116	16	6/12	8411922437256
904118	18	6	8411922437263

Cacerola Recta Mini Vintage

Vintage Straight Mini Casserole
Mini Faitout Droit Vintage
Mini Gerade Fleischtopf Vintage
Mini Tacho Reto Vintage



ref.	∅ (cm)	Lts		Bar Code
902712	12	0,36	6	8411922436907

Olla Bombada Mini Vintage

Vintage Mini Round-Bottomed Pot
Mini Marmite Bombée Vintage
Mini Gebogene Form Gemüsetopf Vintage
Panela Arredondada Mini Vintage



ref.	∅ (cm)	Lts		Bar Code
902812	12	0,50	6	8411922436914

Taza Vintage

Vintage Cup
Tasse Vintage
Tasse Vintage
Caneca Vintage



ref.	∅ (cm)	Lts		Bar Code
904707	7	0,20	6	8411922447217
904708	8	0,26	6	8411922447224

Bol con Pie Vintage

Vintage Bowl with Stand
Bol avec Pied Vintage
Schale mit Fuß Vintage
Tigela com Pé Vintage



ref.	∅ (cm)	H (cm)		Bar Code
903812	12	8	12	8411922204582

Plato de Huevos con Tapa Vintage

Vintage Egg Dish with Lid
Plat à Oeuf avec Couverture Vintage
Serviertöpfehen mit Deckel Vintage
Prato para Ovos com Tampa Vintage



ref.	∅ (cm)	H (cm)	ml		Bar Code
912214T	14	4,50	400	6	8411922474886

Olla Mini Vintage

Vintage Mini Pot
Mini Marmite Vintage
Mini Gemüsetopf Vintage
Panela Mini Vintage



ref.	∅ (cm)		Bar Code
902910	10	6/12	8411922435504

Cazo Cónico con Pico Vintage

Vintage Conical Saucepan with Spout
Casserole Conique avec Bec Verseur Vintage
Konische Stielkasserolle mit Ausguss Vintage
Caçarola Cónica com Bico Vintage



ref.	∅ (cm)		Bar Code
904012	12	6	8411922433395
904410	10	6	8411922437270

Fuente Honda Oval Vintage

Vintage Deep Oval Platter
Plat Ovale Profond Vintage
Tiefes Ovale Tablett Vintage
Bandeja Funda Oval Vintage



ref.	L (cm)	W (cm)		Bar Code
905232	32	25,50	6	8411922440607

Bol Cónico Vintage

Vintage Conical Bowl
Bol Conique Vintage
Konische Schale Vintage
Tigela Cónica Vintage



ref.	∅ (cm)		Bar Code
905116	16	6/12	8411922438451
905120	20	6/12	8411922438468
905124	24	6/12	8411922438475

Rustidera Vintage

Vintage Roast Pan
Plat à Rôtir Vintage
Bratreine Vintage
Tabuleiro Vintage



ref.	L (cm)	W (cm)	H (cm)		Bar Code
905437	37	24	7	6	8411922447040

Fuente Rectangular Vintage

Vintage Rectangular Deep Platter
Plat Rectangulaire Profond Vintage
Tiefes Rechteckiges Tablett Vintage
Bandeja Rectangular Funda Vintage



ref.	L (cm)		Bar Code
905015	15	6	8411922437881
905017	17	6	8411922437898
905020	20	6	8411922437904
905022	22	6	8411922437911
905027	27	6	8411922441208

Sartén Presentación Vintage

Vintage Presentation Pan
Poêle de Présentation Vintage
Präsentationpfanne Vintage
Frigideira de Apresentação Vintage



ref.	∅ (cm)		Bar Code
906214	14	6	8411922456806

Hervidor de Leche con Tapa Vintage

Vintage Milk Boiler with Lid
Pot à Lait avec Couvercle Vintage
Milchkocher mit Deckel Vintage
Fervedor de Leite com Tampa Vintage



ref.	∅ (cm)	H (cm)	Lts		Bar Code
906514	14	13	1,75	2/6	8411922474190

Bandeja Redonda con Asas Vintage

Vintage Round Plate with Handles
Plat Rond avec Anses Vintage
Rundes Tablett mit Griffen Vintage
Bandeja Redonda com Asas Vintage



ref.	∅ (cm)	H (cm)		Bar Code
904122	22	4	6	8411922436631

Escurridor Vintage

Vintage Colander
Égouttoir Vintage Blanca
Sieb Vintage
Escorredor Vintage



ref.	∅ (cm)		Bar Code
911422	22	6	8411922033229

Colador Vintage

Vintage Strainer
Passoire Vintage
Sieb Vintage
Escorredor Vintage



ref.	∅ (cm)		Bar Code
912518	18	12	8411922064186

Espumadera Vintage

Vintage Skimmer
Écumoire Vintage
Schaumlöffel Vintage
Escumadeira Vintage



ref.	∅ (cm)	L (cm)		Bar Code
911910	10	36	12	8411922206586

Cacilo Aceitunas Vintage

Vintage Olives Ladle
Louche à Olives Vintage
Olivenlöffel Vintage
Concha para Azeitonas Vintage



ref.	∅ (cm)	L (cm)		Bar Code
911850	9	36	12	8411922072129

Colgador de Utensilios Vintage

Vintage Wall Utensil Hanger
Crochet à Ustensiles Vintage
Utensilienaufhänger Vintage
Cabide de Utensílios Vintage



ref.	W (cm)	L (cm)		Bar Code
905300	33	47	4	8411922440980

Cubo Vintage 11cm

Vintage Utility Pail / Bucket 11cm
Seau Vintage 11cm
Eimer Vintage 11cm
Balde com Asa Vintage 11cm



ref.	∅ (cm)	H (cm)	Lts		Bar Code
903311	11	11	0,72	6	8411922458824

Lechera Vintage

Vintage Milk Churn
Bidon à Lait Vintage
Milchkanne Vintage
Leiteira Vintage



ref.	∅ (cm)	H (cm)	Lts		Bar Code
904301	10	22	1	6	8411922436204
904302	13	26	2	6	8411922447026

Cacillo Vintage

Vintage Ladle
Louche Vintage
Schöpfkelle Vintage
Concha Vintage



ref.	∅ (cm)	L (cm)		Bar Code
911806	6	25	6	8411922436891
911809	9	36	12	8411922206593

Cucharón Vintage

Vintage Serving Spoon
Cuillère Vintage
Vorlegelöffel Vintage
Colher Vintage



ref.	L (cm)		Bar Code
904500	35	6	8411922440638

Cubo Vintage 14cm

Vintage Utility Pail / Bucket 14cm
Seau Vintage 14cm
Eimer Vintage 14cm
Balde com Asa Vintage 14cm



ref.	∅ (cm)	Lts		Bar Code
903314	14	1,50	6	8411922204537

Mantequillera Vintage

Vintage Butter Dish
Beurrrier Vintage
Butterdose Vintage
Manteigueira Vintage



ref.	L (cm)	W (cm)	H (cm)		Bar Code
905800	17	12	6	6	8411922449716

Flanero Vintage

Vintage Cream Caramel Mold
Moule à Crème Caramel Vintage
Puddingform Vintage
Forma para Pudim FlanVintage



ref.	∅ (cm)	H (cm)	Lts		Bar Code
901008	8	6	0,25	6	8411922458053

Embudo Vintage

Vintage Funnel
Entonnoir Vintage
Trichter Vintage
Funil Vintage



ref.	∅ (cm)	H (cm)	Lts		Bar Code
905713	13	16		6	8411922449709

Frutero Vintage

Vintage Fruit Bowl
Coupe à Fruits Vintage
Obstschale Vintage
Fruteira Vintage



ref.	∅ (cm)	H (cm)	Lts		Bar Code
902626	26	6		6	8411922454925

Panera Vintage

Vintage Bread Basket
Plat à Pain Vintage
Brotkasten Vintage
Cesto de Pão Vintage



ref.	∅ (cm)	H (cm)	Lts		Bar Code
902624	24	4		6	8411922454949

Cubo con Tapa para Compost Vintage

Vintage Compost Bucket with Lid
Seau avec Couvercle pour Compost Vintage
Komposteimer mit Deckel Vintage
Balde com Tampa para Composto Vintage



ref.	∅ (cm)	H (cm)	Lts		Bar Code
906316	17,50	21	4	2/6	8411922474169
906320	22	22,50	6	2/6	8411922474176

Pala Vintage

Vintage Spatula
Pelle Vintage
Schaufel Vintage
Apanhador Vintage



ref.	L (cm)	W (cm)	Lts		Bar Code
906424	34	27		3/6	8411922474183

Palangana Vintage

Vintage Wash Bowl
Cuvette Vintage
Waschschüssel Vintage
Bacia Vintage



ref.	∅ (cm)	H (cm)	Lts		Bar Code
903132	32	10	3,60	6	8411922204513

Jarra Bombada Vintage

Vintage Belly Shape Pitcher
Jarre Bombée Vintage
Gebogene Form Krug Vintage
Jarro Arredondado Vintage



ref.	H (cm)	Lts		Bar Code
903425	25	2,50	6	8411922204544

Jarra de Servir Vintage

Vintage Serving Pitcher
Pichet Vintage
Krug Vintage
Jarro de Servir Vintage



ref.	H (cm)	Lts		Bar Code
904609	12,50	0,75	6	8411922447163

Orinal Vintage

Vintage Chamber Pot
Pot de Chambre Vintage
Töpfchen Vintage
Bacio Vintage



ref.	∅ (cm)	Lts		Bar Code
903522	22	2,70	6	8411922204551
903524	24	3,50	6	8411922205787

Cafetera Cónica Vintage

Vintage Conical Coffee Pot
Cafetière Conique Vintage
Konische Kaffeekanne Vintage
Cafeteira Conica Vintage



ref.	Lts		Bar Code
903210	1	6	8411922204520

Pote Decorado Vintage

Vintage Decorated Mug
Tasse Décoré Vintage
Dekorierter Tasse Vintage
Caneca Decorada Vintage



2A+2B+2C+2D=8

ref.	∅ (cm)	Lts		Bar Code
904808	8	0,40	8	8411922435535

Esmaltado
Vintage.

Petrol.

ACERO ESMALTADO VITRIFICADO
VITRIFIED ENAMELED STEEL
ACIER ÉMAILLÉ VITRIFIÉ
KERAMISCH EMAILLIERTER STAHL
AÇO ESMALTADO VITRIFICADO



Bandeja de Servicio Vintage

Vintage Serving Tray
Plateau de Service Vintage
Servierblett Vintage
Bandeja de Serviço Vintage

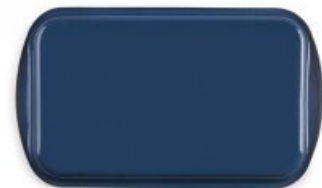

ref.	L (cm)	W (cm)	H (cm)		Bar Code
975500	36	21	2	6	8411922459333



Esmaltado Vintage Surtido.

ACERO ESMALTADO VITRIFICADO

VITRIFIED ENAMELED STEEL

ACIER ÉMAILLÉ VITRIFIÉ

KERAMISCH EMAILLIERTER STAHL

AÇO ESMALTADO VITRIFICADO



Esmaltado
Vintage
Surtido.

Platos de Huevos.

ACERO ESMALTADO VITRIFICADO

VITRIFIED ENAMELED STEEL

ACIER ÉMAILLÉ VITRIFIÉ

KERAMISCH EMAILLIERTER STAHL

AÇO ESMALTADO VITRIFICADO



Plato de Huevos Vintage

Vintage Egg Dish

Plat à Oeuf Vintage

Serviertöpfchen Vintage

Prato para Ovos Vintage

PECHE



PETROL



GRISE



PISTACHO



CIEL



FRAISE



ref.	Ø (cm)	H (cm)	Lts	📦	Bar Code	
942200	14	4,50	0,40	6	8411922459975	PECHE
942201	14	4,50	0,40	6	8411922459982	PETROL
942202	14	4,50	0,40	6	8411922459999	GRISE
942203	14	4,50	0,40	6	8411922460001	PISTACHO
942204	14	4,50	0,40	6	8411922460018	CIEL
942205	14	4,50	0,40	6	8411922460025	FRAISE



Cuenco para Salsas Vintage

Vintage Sauce Bowl

Réceptient pour Sauces

Saucenschüssel Vintage

Tigela para Molhos Vintage



PECHE



PETROL



GRISE



PISTACHO



CIEL



FRAISE



BORDEAUX



BLANCA



MUSGO



ref.	Lts	∅ (cm)	H (cm)	∅	Bar Code	
941600	0,125	7	4	12	8411922456721	PECHE
941650	0,230	9	4,50	12	8411922458862	
941601	0,125	7	4	12	8411922456738	PETROL
941651	0,230	9	4,50	12	8411922458879	
941602	0,125	7	4	12	8411922456745	GRISE
941652	0,230	9	4,50	12	8411922458886	
941603	0,125	7	4	12	8411922456752	PISTACHO
941653	0,230	9	4,50	12	8411922458893	
941604	0,125	7	4	12	8411922456769	CIEL
941654	0,230	9	4,50	12	8411922458909	
941605	0,125	7	4	12	8411922456776	FRAISE
941655	0,230	9	4,50	12	8411922458916	
941606	0,125	7	4	12	8411922456783	BORDEAUX
941656	0,230	9	4,50	12	8411922458923	
941607	0,125	7	4	12	8411922456790	BLANCA
941657	0,230	9	4,50	12	8411922458930	
936312	0,125	7	4	12	8411922457612	MUSGO
941658	0,230	9	4,50	12	8411922458947	



Cubo Vintage 8cm

Vintage Utility Bucket 8cm
Seau Vintage 8cm
Eimer Vintage 8cm
Balde com Asa Vintage 8cm



ref.	∅ (cm)	H (cm)	Lts	∩	Bar Code	
903308	8	8,70	0,35	6	8411922459883	BLANCA
909308	8	8,70	0,35	6	8411922459890	BORDEAUX
935508	8	8,70	0,35	6	8411922459906	MUSGO
942100	8	8,70	0,35	6	8411922459913	PECHE
942101	8	8,70	0,35	6	8411922459920	PETROL
942102	8	8,70	0,35	6	8411922459937	GRISE
942103	8	8,70	0,35	6	8411922459944	PISTACHO
942104	8	8,70	0,35	6	8411922459951	CIEL
942105	8	8,70	0,35	6	8411922459968	FRAISE

Cazuelita Vintage

Vintage Round Dish
Plat Rond Vintage
Runde Schale Vintage
Tacho Baixo Vintage



ref.	∅ (cm)	H (cm)	ml	∩	Bar Code	
941700	10	5	300	6	8411922474893	FRAISE
941701	10	5	300	6	8411922474909	BLANCA
941702	10	5	300	6	8411922474916	BORDEAUX
941703	10	5	300	6	8411922474923	PETROL
941704	10	5	300	6	8411922474930	PECHE

Bolsas Isotérmicas.

POLIESTER

POLYESTER

POLYESTER

POLYESTER

POLIÉSTER



7h

Bolsas Isotérmicas.

Niza.

POLIESTER LINO
LINEN POLYESTER
LIN POLYESTER
LEINEN-POLYESTER
POLIÉSTER DE LINHO



7h

Bolsa Isotérmica

Isothermal Bag 5L

Sac Isotherme

Thermotasche

Saco Isotérmico



5L



10L



15L



20L



30L

ref.	Lts	L (cm)	W (cm)	H (cm)		Bar Code
627605	5	23	19	14	6/12	8411922459647
627610	10	28	16	26	6/12	8411922459654
627615	15	29	20	28	6/12	8411922459661
627620	20	27	24	34	6	8411922459678
627630	30	31	27	39	6	8411922459685



Bolsa Isotérmica

Isothermal Bag
Sac Isotherme
Thermotasche
Saco Isotérmico



5L

10L

15L

20L

30L

ref.	Lts	L (cm)	W (cm)	H (cm)		Bar Code
627705	5	23	19	14	6/12	8411922459692
627710	10	28	16	26	6/12	8411922459708
627715	15	29	20	28	6/12	8411922459715
627720	20	27	24	34	6	8411922459722
627730	30	31	27	39	6	8411922459739



Bolsa Isotérmica

Isothermal Bag
Sac Isotherme
Thermotasche
Saco Isotérmico



5L

10L

15L

20L

30L

ref.	Lts	L (cm)	W (cm)	H (cm)		Bar Code
626405	5	23	19	14	6/12	8411922453225
626410	10	28	16	26	6/12	8411922453232
626415	15	29	20	28	6/12	8411922453249
626420	20	27	24	34	6	8411922453256
626430	30	31	27	39	6	8411922453263



Bolsa Isotérmica

Isothermal Bag
Sac Isotherme
Thermostasche
Saco Isotérmico



5L

10L

15L

20L

30L

ref.	Lts	L (cm)	W (cm)	H (cm)		Bar Code
626505	5	23	19	14	6/12	8411922453270
626510	10	28	16	26	6/12	8411922453287
626515	15	29	20	28	6/12	8411922453294
626520	20	27	24	34	6	8411922453300
626530	30	31	27	39	6	8411922453317

Estuche-Nevera Isotérmica Portátil para Medicamentos

Portable Isothermal Cooler Bag for Medicines
Étui-Glaciére Isotherme Transportable pour Medicaments
Isotherme Tragbare Kühltasche für Medika
Caso Isotérmico Portátil para Medicamentos

ref.	L (cm)	W (cm)	H (cm)		Bar Code
626500	21	10	6	3/6/24	8411922459050



Mochila Isotérmica 21L

Isothermal Backpack 21L
Sac à Dos Isotherme 21L
Isothermer Rucksack 21L
Mochila Isotérmica 21L

ref.	Lts	L (cm)	W (cm)	H (cm)		Bar Code
627221	21	28	20	38	6	8411922457261



Cesta Isotérmica 27L

Isothermal Basket 27L
 Sac Isotherme 27L
 Thermo-Einkaufskorb 27L
 Cesto Isotermico 27L



ref.	Lts	L (cm)	W (cm)	H (cm)		Bar Code
627227	27	47	28	24	6	8411922457278

NEW

Bolsa Isotérmica Porta Botellas

Dalvik Isothermal Bottle Bag
 Sac Isotherme pour Bouteilles Dalvik
 Thermostasche für Flaschen Dalvik
 Bolsa Isotermica para Garrafas Dalvik



ref.	∅ (cm)	H (cm)	Lts		Bar Code
626501	10	32	1,50	6/24	8411922475012

**Bolsas
 Isotérmicas.**

Accesorios.

Acumulador de Frío

Cold Accumulators
 Accumulateurs de Froid
 Kühllakkus
 Acumulador de Frio

- Plástico
- Gel Refrigerante
- Plastic
- Cooling Gel



ref.	Lts	L (cm)	W (cm)	H (cm)		Bar Code
798400	0,06	7,50	7,50	1,80	6/36	8411922453430
798410	0,38	18	9,60	3,20	6/12	8411922453447



SET 3x



SET 2x

SET 3 MINI/SMALL
 SET 2 GRANDE/BIG

NEW

Taza Doble Pared Inox

Double-Walled Stainless Steel Cup
Tasse en Inox à Double Paroi
Doppelwandiger Becher aus Edelstahl
Caneca Parede Dupla Inox

- **Acero Inoxidable 18/10**
- Stainless Steel 18/10

ref.	ml		Bar Code
667403	350	6/24	8411922475418



Pote Inox

Stainless Steel Mug
Gobelet Inox
Tasse Inox
Caneca Inox

- **Acero Inoxidable**
- Stainless Steel



ref.	∅ (cm)	Lts		Bar Code
700308	8	0,30	6/72	8411922604252
700309	9	0,50	6/72	8411922604269
700311	11	1	6/72	8411922604276

Pote

Mug
Verre
Becher
Caneca

- **Aluminio**
- Aluminium



ref.	∅ (cm)	Lts		Bar Code
102308	8	0,35	4/72	8411922137088

Vaso

Tumbler
Timbale
Glas
Copo

- **Acero Inoxidable**
- Stainless Steel



ref.	Lts	∅ (cm)	H (cm)		Bar Code
711503	0,30	7,50	12	12/120	8411922622263

Cantimplora con Vaso Army

Army Canteen with Tumbler
Gourde avec Timbale Army
Feldflasche mit Becher Army
Cantil com Copo Army

- **Aluminio**
- Aluminium



ref.	Lts		Bar Code
720500	1	6	8411922423617

Plato Camping con Anilla

Camping Plate with Ring
Assiette Camping avec Anneau
Camping Teller mit Ring
Prato de Campismo com Anilha

- **Acero Inoxidable**
- Stainless Steel



ref.	∅ (cm)	H (cm)	Lts		Bar Code
711224	24	3,20	0,90	12/72	8411922622232

Plato Camping Hondo con Anilla

Camping Deep Dish with Ring
Assiette Camping Creuse avec Anneau
Camping Tiefe Teller mit Ring
Prato de Campismo Fundo com Anilha

- **Acero Inoxidable**
- Stainless Steel



ref.	∅ (cm)	H (cm)	Lts		Bar Code
714522	22	4	1	6/72	8411922204384

Cubiertos Camping Inox (Set Cuchara + Tenedor + Cuchillo)

Camping Stainless Steel Cutlery (Set Spoon + Fork + Knife)
Couverts de Camping Inox (Set Cuillère + Fourchette + Couteau)
Camping-Besteck Inox (Set Löffel + Gabel + Messer)
Talheres de Campismo Inox (Conjunto Colher + Garfo + Faca)

- **Acero Inoxidable 18/10**
- Stainless Steel 18/10



ref.	L (cm)		Bar Code
720200	17,50	12/48	8411922622478

Fiambreira con 2 Platos Inox

Lunch Box with 2 Stainless Steel Plates
Boîte Alimentaire avec 2 Assiettes Inox
Lunchbox mit 2 Tellern aus Edelstahl
Fiambreira com 2 Pratos Inox

- **Acero Inoxidable**
- Stainless Steel



ref.	∅ (cm)	Lts		Bar Code
720614	14	0,75	1/24	8411922160581
720616	16	1	1/24	8411922160598
720618	18	1,30	1/16	8411922160604
720620	20	1,80	1/16	8411922160611



Vajilla Desechable Eco.

CAÑA DE AZÚCAR. ALMIDÓN DE MAÍZ. PAPEL
SUGAR CANE. CORN STARCH. PAPER
CANNE À SUCRE. AMIDON DE MAÏS. PAPIER
ZUCKERKANNE. KORNERSTÄRKE. PAPIER
CANA DE AÇÚCAR. AMIDO DE MILHO. PAPEL



Plato de Caña de Azúcar

Sugarcane Plate
Assiette Canne à Sucre
Zuckerrohr Teller
Plato de Cana de Açúcar

- **Caña de Azúcar**
- Sugar Cane



ref.	∅ (cm)	H (cm)		Bar Code	
260016	16	2	10	8411922452242	12 uds
260020	20	2	10	8411922452259	12 uds
260024	24	2	10	8411922452266	12 uds

Vaso de Almidón de Maíz (Bebida Fría)

Corn Starch Cup (Cold Drinks)
Verre en Amidon de Maïs (Boisson Froide)
Maisstärke Becher (Kaltgetränke)
Copo de Amido de Milho (Bebidas Frias)

- **Almidón De Maíz**
- Corn Starch



ref.	∅ (cm)	H (cm)		Bar Code	
260402	7,50	9	10/20	8411922452334	15 uds
260403	8	11	10/20	8411922452341	15 uds
260405	9,50	13,50	10/20	8411922452358	15 uds
260410	11,50	15	10/20	8411922452365	10 uds

Tenedor de Almidón de Maiz

Corn Starch Fork
Fourchette en Amidon de Maïs
Maisstärkergabel
Garfo de Amido de Milho



- Almidón De Maiz
- Corn Starch

ref.	L (cm)		Bar Code	
260101	16,50	10/50	8411922452280	6 uds

Cuchillo de Almidón de Maiz

Corn Starch Knife
Couteau Amidon de Maïs
Maisstärkemesser
Faca de Amido de Milho



- Almidón De Maiz
- Corn Starch

ref.	L (cm)		Bar Code	
260100	16,50	10/50	8411922452273	6 uds

Cuchara de Almidón de Maiz

Corn Starch Spoon
Cuillère en Amidon de Maïs
Maisstärke Löffel
Colher de Amido de Milho



- Almidón De Maiz
- Corn Starch

ref.	L (cm)		Bar Code	
260102	16,50	10/50	8411922452297	6 uds

Cucharilla de Almidón de Maiz

Corn Starch Teaspoon
Petite Cuillère en Amidon de Maïs
Maisstärke Teelöffel
Colher de Chá de Amido de Milho



- Almidón De Maiz
- Corn Starch

ref.	L (cm)		Bar Code	
260103	12,50	10/50	8411922452303	6 uds

Surtido 4 Colores Pajitas de Papel

Assorted 4 Color Paper Straws
Assortiment 4 Couleurs Pailles
Sortierte Papierstrohhalm in 4 Farben
Sortido de Palhinhas de Papel 4 Cores



- Papel
- Paper

ref.	L (cm)		Bar Code	
260300	20	10/100	8411922452327	48 uds

Expositor Eco

Eco Display
Exposant Eco
Ständer Eco
Stand Eco

- Cartón
- Cardboard

ref.	L (cm)	W (cm)	H (cm)		Bar Code
000909	59	38	187	1	8411922453768

Ref.	Desc.	Cantidad / Quantity
260300	Pajitas/Paper straws	20 packs de/of 48u.
260024	Platos/Plates 24cms	20 packs de/of 12u.
260020	Plato/Plates 20cms.	20 packs de/of 12u.
260102	Cuchara/Spoon	50 packs de/of 6u.
260016	Plato/Plates 16cms.	10 packs de/of 12u.
260100	Cuchillos/Knives	50 packs de/of 6u.
260103	Cucharillas/Teaspoon	50 packs de/of 6u.
260402	Vaso/Cup 220ml	20 packs de/of 15u.
260403	Vaso/Cup 350ml	20 packs de/of 15u.
260405	Vaso/Cup 500ml	10 packs de/of 15u.
260410	Vaso/Cup 1000ml	10 packs de/of 10u.
260101	Tenedor/Fork	50 packs de/of 6u.



Expositor Columna para Sartenes

Column Display for Frying Pans
Exposant Colonne Poêle
Ständer für Bratpfannen
Expositor de Coluna para Frigideiras

- Acero
- Steel

ref.	L (cm)	W (cm)	H (cm)		Bar Code
000999	45	45	180	1	8411922458350



Expositor Recto + 20 Ganchos

Straight Stand + 20 Hooks
Exposant Droit + 20 Crochels
Gerader Ständer + 20 Haken
Expositor Recto + 20 Ganchos

- Metálico
- Metallic



ref.	W (cm)	H (cm)		Bar Code
000888	78	185	1	8411922091465

Expositor Curvo + 12 Ganchos

Curved Stand + 12 Hooks
Exposant Courbe + 12 Crochels
Gebogener Ständer + 12 Haken
Expositor Curvo + 12 Ganchos

- Metálico
- Metallic



ref.	W (cm)	H (cm)		Bar Code
000887	57	185	1	8411922008876

Ganchos para Expositor

Display Hooks
Crochels
Displayhaken
Ganchos

- Metálico
- Metallic

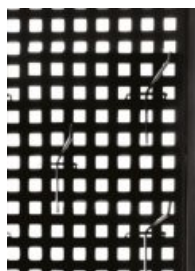

ref.	L (cm)		Bar Code
000008	22	1	0

Bandeja para Expositor Recto

Shelf for Straight Stand
Etagère pour Exposant Droit
Regal für Gerader Ständer
Estante para Expositor Recto

- Metálico
- Metallic



ref.	W (cm)		Bar Code
000888B	78	1	8411922438321





A

ABLANDA CARNE	387
ABREBOTES	325, 349, 350
ABRECHAPAS	384, 385
ABRELATAS	324, 349, 385
ABREOSTRAS	325, 351
ABRIDOR DE CHAMPÁN	372
ACCESORIO RAVIOLI	246
ACEITERA	253, 254, 257, 258, 259, 260
ACUMULADOR DE FRIO	413
ADAPTADOR INDUCCIÓN-VITRO	35, 198
ADAPTADOR PARA CABEZAL SOPLETE	129
ADAPTADORES	157
AFILADOR	290, 291
AGUJA DE BRIDAR	351
AIREADOR DE VINO	375, 377
ALFOMBRILLA ESCURRIDOR	361
ANILLAS NIVELADORAS	182
ANILLO ANTIGOTEO	376
AROS PRESENTACIÓN	130, 131, 132
ASADOR DE POLLOS	386
ASAS	20, 43, 74, 316
ATRIL	361
AZUCARERO	262, 396

B

BAJOPLATO	366
BANDEJA	263, 266, 391, 392, 393, 397, 401, 403
BANDEJA DE MANTEQUILLA	253, 366, 399, 404
BANDEJA DE SERVICIO	406
BANDEJA HORNO	78, 87, 94
BANNETON	104
BASES	187
BATERÍAS	26
BATIDOR	170, 171, 172, 231, 324
BIBERONES	161
BLONDA	180, 181
BOL	239, 263, 264, 265, 393, 397, 398, 401, 402, 403
BOL SEMIESFERICO	117, 264
BOLA PARA COCIDO	353
BOLAS DE TÉ	210
BOLAS DECANTADOR	377
BOLAS REPOSTERIA	173
BOLSA FILTRO PARA LECHE	353
BOLSA ISOTERMICA	410, 411, 412, 413
BOLSA PARA FRUTA	352
BOLSA PARA GRILL	387
BOLSAS PARA ASAR	386
BOLSAS PARA PAN	251
BOMBA DE VACIO	372, 373, 375
BOQUILLAS	153, 154, 155, 156, 160
BOTE RESIDUOS	364
BOTELLA	212, 213, 214, 215, 216, 217, 218, 219, 220, 226, 227
BOTES	278, 280, 281
BROCHETAS	339, 358
BUÑOLERA	125
BÁSCULA	164

C

CACEROLA	17, 18, 19, 20, 22, 24, 25, 28, 29, 31, 33, 402
CACEROLA HORNO	34
CACEROLA VAPOR	25
CACILLO	322, 323, 325, 327, 328, 329, 330, 331, 332, 333, 394,

	399, 404
CACILLO ACEITUNAS	331, 404
CAFETERA CÓNICA	394, 395, 396, 400, 406
CAFETERA EXPRESS	193, 194, 195, 196, 197, 198
CAFETERA PAVA	199, 396
CAFETERA SILBANTE	200
CAFETERA TURCA	396
CAFETERA-ÉMBOLO	199
CAJAS	119, 182, 229
CALENTADOR TETERAS	208
CANTIMPLORAS	414
CARGAS SIFÓN NATA	134
CARGAS SIFÓN SODA	384
CASCANUECES	304
CAZO	20, 22, 24, 25, 26, 27, 29, 31, 32, 33, 393, 398, 400, 402
CAZO BAÑO MARIA	117
CAZO FREIDOR	27
CAZOS DE MEDIDAS	175
CAZUELITA	26, 28, 32, 391, 409
CENTRIFUGADORA ENSALADA	341, 342
CEPILLO LIMPIACORNETES	156
CEPILLO LIMPIADOR BOTELLAS	230
CEPILLO PARA CACEROLAS	363
CEPILLO PARA VERDURAS	364
CESTA DE HUEVOS	360
CESTA PARA PAN	251
CESTILLO FREIDOR	66, 366
CESTILLO VAPOR	25, 36, 242, 245
CHURRASQUERA	67
CHURRERA	135, 136
CLIPS	362
COCEDOR PASTA/ESPARRAGOS	36
COCOTTE	30, 33, 399, 400
COCTELERA	380
COLADOR	209, 267, 268, 404
COLADOR COCKTAIL	380
COLGADOR DE TRAPOS	361
COLGADOR MURAL	340, 404
COLGADOR PARA BROCHETAS	358
COMPROBADOR DE TARTAS	172
CONSERVADOR DE FRUTAS	270
CONTENEDORES	279
CORTADOR CROSTATA	150
CORTADOR DE DONUTS	145
CORTADOR DE ENSALADILLA	292
CORTADOR DE FOIE	297
CORTADOR DE LIMONES	294
CORTADOR DE LÁMINAS	299
CORTADOR DE MANZANAS	296
CORTADOR DE MELÓN Y PIÑAS	296
CORTADOR DE RAVIOLIS	247, 248
CORTADOR DE SANDIA	295
CORTADOR DE VERDURAS	293, 297
CORTADOR EN VIRUTAS	116
CORTADOR PARA CHEBAKIA	140
CORTAHUEVOS	298
CORTAMASAS	138, 149
CORTAPASTAS	126, 136, 137, 139, 140, 141, 142, 143, 144, 145, 146, 147, 185, 186, 187
CORTAPATATAS	292, 293, 294
CORTAPIZZA	249, 250, 325
CORTAPIÑAS	295
CORTAQUESOS	297, 325
CUBIERTOS	275, 282, 283, 415
CUBITERA	379
CUBO	379, 394, 396, 398, 400, 404, 405, 409
CUBO CHAMPÁN	379

CUBO PARA RECICLAJE	364
CUCHARA	168, 169, 324, 325, 327, 328, 329, 331, 332, 333, 335, 336, 337, 338, 399, 404
CUCHARA ESFERIFICACIONES	366
CUCHARA MEDIDAS	175
CUCHARA PASTA	324, 325, 327, 328, 331, 332, 335
CUCHARILLA COCKTAIL	380
CUCHARILLAS PRESENTACIÓN	365
CUCHILA PARA PAN	250
CUCHILLO	284, 285, 286, 287
CUCHILLO FONDANT	182
CUCHILLO PARA QUESO	287, 324
CUENCO	266, 408
CÁPSULA BOMBÓN	178, 179
CÁPSULA MADALENA	176, 177, 178, 179
CÁPSULAS CUPCAKE	160, 178, 179, 180

D

DECORADORES	149, 160, 161, 162, 229
DECORADORES VERDURAS	298
DECORAZONADOR PIMIENTOS	294
DESCALCIFICADOR DE TETERAS	229
DESCAPSULADOR	323, 372, 385
DESCORAZONADOR	295, 323
DESCORAZONADOR TOMATE	326
DESGRANADOR	304
DESHUESADOR DE CEREZAS	296
DESHUESADOR DE MANGO	296
DIFUSOR PARA GAS	35
DISPENSADOR DE AGUA	388
DISPENSADOR DE ALIÑO	275
DISPENSADOR DE CÁPULAS	211
DISPENSADOR DE DETERGENTE	363
DISPENSADOR DE FILM/PAPEL	360
DISPENSADOR DE HELADO	122, 123
DISPENSADOR DE MIEL	262
DISPENSADOR DE QUESO	262

E

ECO	415, 416
ELIMINA GRASAS	243
EMBUDO	346, 347, 405
EMBUDO CONFITURAS	346
EMPANADERA	100
ENCENDEDOR	389
ENFRIABOTELLAS	377, 378, 379
ENFRIADOR DE LATAS	378
ENVASADOR DE CAPSULAS	230
ENVOLTORIO PARA CUPCAKE	179
ESCALFADOR	95, 241
ESCANCIADOR	374, 375, 376
ESCURRECUBIERTOS	340
ESCURRIDOR	267, 268, 360, 394, 399, 403
ESCURRIDOR DE PLATOS	360
ESPECIERO	362
ESPOLVOREADOR	173
ESPONJA ESMERIL	363
ESPONJA LIMPIADORA SIFONES	230
ESPUMADERA	243, 322, 326, 327, 328, 329, 330, 331, 332, 333, 335, 337, 394, 399, 404
ESPÁTULA	168, 169, 323, 324, 325, 327, 328, 329, 330, 331, 332, 333, 337, 338
ESPÁTULA PARA CREPES	172, 330, 336
ESPÁTULA PARA MANTEQUILLA	287, 326
ESPÁTULA PARA TORTILLAS	330, 334
ESPÁTULA PLANCHA	331
ESPÁTULA REPOSTERÍA	166, 167, 169, 170, 171, 172
ESPÁTULA TAMAGOYAKI	57
ESTECAS	183

ESTUCHE DE VAPOR	241
ETIQUETAS PARA VINO	377
EXPOSITOR	74, 240, 417
EXPRIMIDOR	342, 379, 380

F

FIAMBRE	275, 415
FILTROS	208, 209, 210, 353
FLANERO	79, 80, 81, 82, 84, 85, 90, 93, 94, 98, 99, 101, 105, 124, 398, 405
FONDUE	243
FREIDORA	28, 55, 57, 59, 61
FRUTERO	399, 405
FUENTE	104, 105, 107, 108, 109, 266, 399, 403
FUNDA PARA RODILLO	352

G

GAFAS	298
GAS	129, 130
GRASERA	255, 256
GRILL	41, 43, 44, 46, 48, 49, 50, 53, 55, 58
GRILL PIEDRA	357, 358
GUARDAVERDURAS	278
GUÍA CORTABIZCOCHOS	152
GUÍA CORTACEBOLLAS	297

H

HARINERO	269
HERVIDOR	28, 31, 201, 403
HILADOR DE HUEVO	161
HILO DE COCINA	351
HUEVERA	360

I

INFUSOR	209
INYECTOR	386

J

JAMONERO	337
JARRA	201, 209, 225, 347, 348, 394, 395, 405, 406
JARRA MEDIDAS	174, 243
JUEGO DE VINO	375

K

KIT BARRITAS ENEGETICAS	242
KIT CROQUETAS	127
KIT FIAMBRE	242
KIT PARA MATE	229
KIT PETIT CHOC	141

L

LAMINA ANTIADHERENTE	190
LAMINADOR AJOS	299
LAMINADOR DE AGUACATE	299
LAPIZ DECORADOR	161
LATA TERMO	222
LECHERA	231, 348, 394, 399, 404
LECHERA SERVIR	396
LIBRADOR	365
LIRA PARA QUESO	297
LIRA PARA TARTAS	148
LUNCH AWAY	274
LUPA PARA FRIGORIFICO	388

M

MACERADOR	381
MADERA	334, 335, 336, 379
MALLA PARA CARNE	352
MANDOLINA	299, 300
MANGAS REPOSTERÍA	157, 158, 159, 160
MANO PARA CHINO	268
MANOPLA	390
MAQUINA PARA CROQUETAS	127
MARCADOR DE COPAS	377
MARCADOR DE TARTAS	148
MAZO TENDERIZADOR	323, 335
MECHADOR	325
MEDIDOR DE LICOR	381
MEDIDOR DE SPAGUETTI	247
MOLDE 3D	111, 184, 185
MOLDE ALTO	78, 80, 82, 85, 92, 95, 103, 105
MOLDE ANGEL FOOD	101
MOLDE ANODIZADO	188, 189
MOLDE ASPIC	96
MOLDE BAGUETTE	93, 99
MOLDE BAJO	80
MOLDE BOLA	112
MOLDE BOLSO	111
MOLDE BOMBÓN	113, 114, 115, 116
MOLDE CAKE	77, 79, 80, 82, 84, 85, 87, 90, 95, 97, 99, 101, 102, 103, 105
MOLDE CAKE POP	124
MOLDE CANELÉ	97
MOLDE CANUTILLO	96, 99, 100
MOLDE CAVIDADES	82, 85, 86, 125
MOLDE CHOCOLATE	111, 115, 116
MOLDE CORAZÓN	77, 95, 98, 111, 112
MOLDE CUADRADO	78, 94
MOLDE DARIOLE	97
MOLDE DESMONTABLE	77, 79, 81, 88, 89, 90, 95, 98, 101
MOLDE DESMONTABLE CON BASE DE CRISTAL	83
MOLDE DOUGHNUT	83, 92
MOLDE EMPANADILLAS	126, 127
MOLDE EXTENSIBLE	100
MOLDE FALAFEL	244
MOLDE FLORÓN	125, 126
MOLDE GELATINA	124
MOLDE GINGER	111
MOLDE GOFRES	126
MOLDE GOMINOLAS	123
MOLDE HALLOWEEN	91
MOLDE HAMBURGUESA	343, 344
MOLDE HELADOS	121, 122
MOLDE HIELO	382, 383
MOLDE HUEVO	96, 126
MOLDE HUEVO DE PASCUA	95, 112
MOLDE KUGELHOF	94
MOLDE LETRAS	184
MOLDE MADALENA	95, 179
MOLDE MUFFIN	78, 87, 90, 91
MOLDE NAVIDAD	77, 92
MOLDE NIDO	366
MOLDE OSITO	96, 124
MOLDE PAN	95, 102, 103
MOLDE PANCAKE	123
MOLDE PANDORO	92
MOLDE PANETTONE	96, 102
MOLDE PASTEL DE NATA	101
MOLDE PIZZA	78, 79, 81, 97, 102
MOLDE PUSH UP	124
MOLDE RAVIOLI	248
MOLDE RECTANGULAR	87, 93
MOLDE RIZADO	78, 80, 81, 82, 85, 86, 87, 90, 94, 97, 105
MOLDE SAVARIN	78, 79, 80, 82, 85, 94, 97, 101, 103
MOLDE SEMIESFERA	100

MOLDE SUSHI	245
MOLDE TARTA "PIE"	149
MOLDE TORTUGA	112
MOLDE TRONCO	94
MOLDE TURRÓN	118, 119, 120
MOLDE ZAPATO	110
MOLDE À BÛCHE	100, 112
MOLDES MINI	92, 97, 102
MOLINILLO	294, 313, 344, 345
MOLINILLO DE CAFÉ	210
MORTERO	345, 346
MÁQUINA DE PASTA	246

O

OLLA	20, 21, 24, 25, 29, 31, 33, 398, 402
OLLA A PRESIÓN	15, 16
OLLA PARA ESPARRAGOS	25
OLLA PARA MEJILLONES	34
OLLA PARA PASTA	31
ORGANIZADOR DE CAJONES	359, 360
ORGANIZADOR DE LATAS	359
ORINAL	394, 395, 400, 406

P

PAELLERAS	71, 72, 73
PAJITAS	231
PALA	405
PALA DE PESCADO	324, 335
PALA PARA PIZZA	249
PALA SERVIR TARTAS	172, 324
PALANGANA	394, 395, 400, 405
PALETA	166, 167, 168, 323
PALILLOS	339
PALOS PARA PIRULETAS	124
PANERA	250, 251, 405
PAPEL DE HORNO	189
PAPEL PARA HAMBURGUESAS	343
PAPEL PARA VAPORERA	245
PARRILLA	355, 356, 357
PASADOR DE FRUTAS	269
PASAPURÉS	269
PELA AJOS	302
PELADOR DE CALABAZAS	303, 304
PELADOR DE CASTAÑAS	303
PELADOR DE ESPÁRRAGOS	301
PELADOR DE JUDIAS	301
PELADOR DE NARANJAS	303
PELAMANZANAS	301
PELAPATATAS	301, 302, 303, 326
PELATOMATES	302, 326
PERFORADOR DE HUEVOS	298
PICADOR	305, 306
PICADOR DE AJOS	302, 306
PICADOR DE HIELOS	384
PICADOR RÁPIDO	305
PICO VERTEDOR	387
PIEDRA PARA PIZZA	248
PINCEL	168, 169, 170, 172, 173, 183, 324
PINCHO PARA CARACOLES	390
PINZA PARA PLATOS	310
PINZA PARA TARROS	310
PINZAS	170, 307, 308, 309, 310, 334, 337, 367
PINZAS PARA FONDANT	149, 183
PINZAS PARA HORNO	310
PIPETA PARA SALSAS	386
PISADOR	132, 149
PLACA PARA DESCONGELAR	387
PLATO	338, 391, 393, 396, 397, 398, 401, 402, 414
PLATO HIERRO FUNDIDO	67, 68
PLATO PARA HUEVOS	407

PLUMA DECORADORA	365
PORTATARTAS	163
PORTATORTILLAS	276
PORTAUTENSILIOS	339, 340
POTE	393, 395, 396, 397, 400, 401, 406, 414
PRENSA HAMBURGUESAS	343
PRENSA LATAS	388
PRENSA PATATAS	326
PRENSA TORTILLAS	246
PRENSA-AJOS	306, 323
PROTECTOR DE DEDOS	297
PROTECTOR DE SARTENES	66

Q

QUEMADOR	130
----------	-----

R

RABANERA	366
RACIONADOR DE HELADO	123, 325
RALLADOR	311, 312, 313, 324, 326
RALLADOR DE LIMONES	325
RAMEQUIN	103
RASPADOR DE PESCADO	303
RASQUETA	149, 166, 167, 168
RASQUETA VITROCERÁMICA	364
RECIPIENTE PARA FREIDORA DE AIRE	106
RECOGEMIGAS	361, 362
RECOGEVERDURAS	298
REJILLA	162
REJILLA FREGADERO	363, 364
REJILLA PARA PIZZA	249
REPOSA TETERAS	207
REPOSA UTENSILIOS	358, 359
ROCIADOR DE SALSAS	386
RODILLO AMASAR	172, 336
RODILLO DE REPOSTERIA	151
RODILLO DE ROMBOS	150
RODILLO MILRAYAS	182
RODILLO PARA CROISSANT	150
RODILLO PUNTEADOR	150
ROLLO DE PVC	132
ROMPEMARISCO	350, 351
ROSQUILLERA	136
RULETA CORTAPASTA	139, 323
RUSTIDERAS	78, 107, 108, 109, 399

S

SACACORCHOS	369, 370, 371, 372
SACAPUNTAS	293
SACO DE LEGUMBRES	352
SACO PARA JAMÓN	353
SALERO DE COCINA	252, 253
SALERO-PIMENTERO	254, 261, 262
SALSERA	253, 366
SALVAMANTEL	367
SARTÉN	39, 40, 41, 42, 45, 46, 47, 49, 50, 51, 52, 54, 55, 56, 57, 58, 59, 60, 63, 64, 65, 398, 403
SARTÉN BLINIS	61
SARTÉN DE CREPES	41, 48, 53, 55, 57, 59, 62
SARTÉN HONDA	40, 47, 49, 51, 52, 53, 55, 56, 57, 65
SARTÉN PARA CASTAÑAS	62
SARTÉN PESCADO	59
SARTÉN TAMAGOYAKI	57
SARTÉN TORTILLAS	43, 47, 50, 51, 53, 54, 59, 60
SAUTEX	46
SECADOR DE PASTA FRESCA	247
SELLOS	148, 185
SEPARADOR DE YEMAS	354
SERVILLETERO	367

SET MATCHA	229
SIFÓN DE NATA	133, 134
SIFÓN DE SODA	384
SOPLETES	128, 129
SOPORTE DE MANGAS	158
SOPORTE GIRATORIO	162, 163
SOPORTE PARA CUCHILLOS	291
SOPORTE PARA CUPCAKE	163
SOPORTE PARA HUEVO	367
SOPORTE PARA PLATO HIERRO	67
SOPORTE PARA TACOS	246
SOPORTE QUEMADOR	130
SOPORTE UTENSILIOS	329, 333
SPRAY DESMOLDEANTE	190

T

TABLA	318, 319, 320
TABLA PARA GNOCCI	247
TABILLAS NIVELADORAS	183
TAJINE	244
TAMIZADOR	173
TAPA	314, 315, 316, 317
TAPA DE CRISTAL CON BASE	317
TAPA MICROONDAS	317
TAPALIMENTOS	317
TAPAS PARA FLANERO	98
TAPETE HORNO	85, 189
TAPETE MEDIDAS	182
TAPONES	373, 374, 375, 376, 377
TAPONES BOMBA DE VACIO	372, 373
TARRO	231, 252, 278, 279, 280
TARRO PARA AJOS	252
TAZA	239, 414
TAZA DE TÉ	228, 398, 400, 402
TAZA+PLATILLO	208, 398, 402
TELA	352
TEMPORIZADOR	368
TENACILLAS	307
TENEDOR	324, 328, 329, 338
TERMOMETRO	117, 118, 320, 321, 377
TERMOS	223, 224, 225, 226
TETERA	200, 201, 202, 203, 204, 205, 206, 207, 395, 396, 400
TIJERAS	288, 289
TORTILLERO	246
TOSTADOR DE PAN	66
TÁPER	271, 272, 273, 274, 275, 276, 277

U

UTENSILIO PARA CHOCOLATINAS	116
-----------------------------	-----

V

VACIADOR	161, 296, 325
VAJILLA PORCELANA	235, 236, 237, 238
VAPORERA	245
VAPORIZADOR DE ACEITE	260
VASO	414
VASO DE TÉ	228
VASO MEDIDAS	174, 175, 381, 398
VASO TERMO	220, 221, 223
VASOS PARA HELADO	122
VELAS ANIVERSARIO	164, 165
VINAGRERAS	254, 261

W

WOK	40, 41, 42, 43, 46, 47, 53, 58, 59, 62
-----	--

Alphabetical index.



A

ADAPTER FOR TORCH	129
ADJUSTABLE PASTRY MOULD	100
ANGEL FOOD MOULD	101
ANODIZED MOULD	188, 189
ANTI-DRIP NECK	376
APPETIZER DISH	366
APPLE CORER	295, 323
APPLE PEELER	301
APPLE SLICER	296
ASPARAGUS POT	25
ASPARRAGUS PEELER	301
ASPIC MOULD	96
AVOCADO SLICER	299

B

BAG FOR PLANT MILK	353
BAG FOR VEGETABLES	352
BAGS FOR GRILL	387
BAGUETTE PAN	93, 99
BAKING CUPS	176, 177, 178, 179
BAKING SHEET	85, 189
BALLING SPOON	366
BALLS FOR DESSERTS	173
BANNETON	104
BASE	187
BEANS SLICER	301
BIN FOR RECYCLING	364
BIRD'S NEST MOULD	366
BIRTHDAY CANDLES	164, 165
BLINIS PAN	61
BOILED EGG CUP	367
BOTTLE	212, 213, 214, 215, 216, 217, 218, 219, 220, 226, 227
BOTTLE CLEANING BRUSH	230
BOTTLE COOLER	377, 378, 379
BOTTLE OPENER	323, 372, 385
BOTTLE POURERS	373, 374, 375, 376, 377
BOWL	239, 263, 264, 265, 393, 397, 398, 401, 402, 403
BOWL SEMI-ROUND	117, 264
BOX FOR SWEETS	119, 182, 229
BREAD BAG	251
BREAD BASKET	251
BREAD BOX	250, 251, 405
BREAD MARKING KNIFE	250
BREAD TOASTER	66
BRUSH	168, 169, 170, 172, 173, 183, 324
BUCKET	379, 394, 396, 398, 400, 404, 405, 409
BUNDT PAN	94
BURGER PRESS	343
BURNER	130
BUTTER DISH	253, 366, 399, 404
BUTTER KNIFE SPREADER	287, 326
BÛCHE MOULD	100, 112

C

CAKE HOLDER	163
CAKE LEVELER	148
CAKE MOULD	77, 79, 80, 82, 84, 85, 87, 90, 95, 97, 99, 101, 102, 103, 105
CAKE POPS MOULD	124
CAKE SERVER	172, 324
CAKE SLICER	152
CAKE TESTER	172

CAN COOLER	378
CAN CRUSHER	388
CAN ORGANIZER	359
CANDY CASES	178, 179
CANNING JAR LIFTER	310
CASSEROLE	17, 18, 19, 20, 22, 24, 25, 28, 29, 31, 33, 402
CAST IRON PLATE	67
CHAMBER POT	394, 395, 400, 406
CHAMPAGNE BOTTLE OPENER	372
CHAMPAGNE COOLER	379
CHARGER PLATE	366
CHEBAKIA CUTTER	140
CHEESE KNIFE	287, 324
CHEESE SHAKER	262
CHEESE SLICER	297, 325
CHERRY STONER	296
CHESNUT PAN	62
CHESSE CUTTER	297
CHESTNUT PEELER	303
CHICKEN ROAST STAND	386
CHOCOLATE PAN	113, 114, 115, 116
CHOPPER/SCRAPPER	298
CHOPPER	305, 306
CHOPPER QUICK	305
CHOPSTICKS	339
CHRISTMAS PAN	77, 92
CLEANING BRUSH FOR POTS	363
CLIP	362
CLIP FOR DISHES	310
CLOTH	352
COCKTAIL SHAKER	380
COCKTAIL SPOON	380
COCKTAIL STRAINER	380
COCOTTE	30, 33, 399, 400
COFFEE CAPSULE FILLER	230
COFFEE GRINDER	210
COLANDER	209, 267, 268, 404
COLD ACUMULATOR	413
COLD MEAT KIT	242
CONDIMENTS DISPENSER	275
CONE FOR JAMS	346
CONICAL COFFEE MAKER	394, 395, 396, 400, 406
CONTAINER FOR AIR FRYER	106
COOKBOOK STAND	361
COOKIE CUTTERS	126, 136, 137, 139, 140, 141, 142, 143, 144, 145, 146, 147, 185, 186, 187
COOKIE GUN	135, 136
COOKING BALL	353
COOKING MAT	190
COOKWARE SETS	26
CORKSCREW	369, 370, 371, 372
COUPLERS	157
COVER FOR MICROWAVE	317
CREAM CARAMEL MOULD	79, 80, 81, 82, 84, 85, 90, 93, 94, 98, 99, 101, 105, 124, 398, 405
CREAM CUSTARD MOULD	101
CREAM JUG	396
CREAM ROLL MOULD	96, 99, 100
CREPE PAN	41, 48, 53, 55, 57, 59, 62
CREPE SPATULE	172, 330, 336
CRIMPERS FOR FONDANT	149, 183
CROISSANT CUTTER ROLLER	150
CROQUETTE MACHINE	127
CROQUETTES KIT	127
CROSTATA CUTTER	150
CRUMBS CLEANER	361, 362
CUPCAKE MOULD	160, 178, 179, 180

CUPCAKE SUPPORT	163
CUPCAKE WRAPPER	179
CUTLERY	275, 282, 283, 415
CUTLERY STRAINER	340
CUTTIN BOARD	318, 319, 320
CYLINDRICAL POT	28, 31, 201, 403

D

DECANTER CLEANING BALLS	377
DECORATING PEN	161
DECORATING TOOLS	298
DECORATING TUBES	153, 154, 155, 156, 160
DICER	292, 293, 294
DIFFUSER FOR GAS	35
DISH	338, 391, 393, 396, 397, 398, 401, 402, 414
DISH DRAINER	360
DISH DRAINER MAT	361
DISPENSER FOR COFFEE CAPSULES	211
DISPENSER FOR WATER	388
DOILIES	180, 181
DONUT MAKER	136
DOUBLE BOILER	117
DOUGH CUTTER	138, 149
DOUGHNUT MOLD	83, 92
DRAWER ORGANIZER	359, 360
DUMPLING MAKER	126, 127

E

EASTER EGG MOULD	95, 112
ECO	415, 416
EGG BASKET	360
EGG DISH	407
EGG HOLDER	360
EGG MOULD	96, 126
EGG PIERCER	298
EGG POACHER	95, 241
EGG SLICER	298
EGG SPLITTER	161
EMERY SPONGE	363
"EMPANADA" PAN	100
ESPRESSO COFFEE MAKER	193, 194, 195, 196, 197, 198

F

FALAFEL MOULD	244
FAT ERASER	243
FILTERS	208, 209, 210, 353
FINGER SHIELD	297
FISH FRY PAN	59
FISH SCALER	303
FISH SERVER	324, 335
FLAN CUP LIDS	98
FLOUR BIN MESH	269
FLUTTED MOULD	97
FOIE-GRAS CUTTER	297
FONDANT ICING LEVEL	183
FONDUE	243
FOOD CONTAINERS	271, 272, 273, 274, 275, 276, 277
FOOD COVER	317
FOOD MILL	269
FOOD SABER	278, 280, 281
FORK	324, 328, 329, 338
FRITTER LADLE	125
FRUIT BALLER	161, 296, 325
FRUIT BOWL	399, 405
FRUIT PERSERVER	270
FRUIT SQUEEZER	342, 379, 380
FRY PAN	39, 40, 41, 42, 45, 46, 47, 49, 50, 51, 52, 54, 55, 56, 57, 58, 59, 60, 63, 64, 65, 398, 403

FRY PAN DEEP	40, 47, 49, 51, 52, 53, 55, 56, 57, 65
FRYING BASKET	66, 366
FRYING SET	28, 55, 57, 59, 61
FUNNEL	346, 347, 405

G

GARLIC CHOPPER	302, 306
GARLIC JAR	252
GARLIC PEELER	302
GARLIC PRESS	306, 323
GARLIC SLICER	299
GAS	129, 130
GINGER MOULD	111
GIROLLE SCRAPER	116
GLASS COVER WITH BASE	317
GLASS MARKERS	377
GNOCCI BOARD	247
GOOGLES	298
GRATER	311, 312, 313, 324, 326
GRAVY BOAT	253, 366
GRILL	41, 43, 44, 46, 48, 49, 50, 53, 55, 58
GRILL GAZ	67
GRINDER	294, 313, 344, 345
GUMMY BEAR MOLD	123

H

HALF SPHERE MOULD	100
HALLOWEEN	91
HAM BAG	353
HAM STAND	337
HAMBURGUER MAKER	343, 344
HAMBURGUER PATTY PAPER	343
HANDBAG MOULD	111
HANDLES	20, 43, 74, 316
HEART SHAPE MOULD	77, 95, 98, 111, 112
HERB BOX	362
HOLDERS FOR DISH RAG	361
HONEY DISPENSER	262

I

ICE BUCKET	379
ICE CREAM GLASSES	122
ICE CREAM MOULDS	121, 122
ICE CREAM SCOOP	123, 325
ICE CRUSHER	384
ICE MOULDS	382, 383
ICE SHOVEL	365
ICING GADGETS	149, 160, 161, 162, 229
INDUCTION-VITROCERAMIC ADAPTER	35, 198
INFUSER	209
ISOTHERMAL BAG	410, 411, 412, 413

J

JAR	231, 252, 278, 279, 280
JAR OPENER	325, 349, 350
JELLY MOULDS	124

K

KETTLE DESCALER	229
KETTLES	199, 396
KITCHEN GRATER	299, 300
KITCHEN SCALE	164
KITCHEN STRING	351
KITCHEN TOOLS HOLDER	339, 340
KNIFE	284, 285, 286, 287
KNIFE-FONDANT	182

L

LADLE	322, 323, 325, 327, 328, 329, 330, 331, 332, 333, 394, 399, 404
LARDING NEEDLE	325
LATTICE CUTTING ROLLER	150
LEMON CUTTER	294
LEMON GRATER	325
LEVELING RINGS	182
LID	314, 315, 316, 317
LIGHTERS	389
LIQUEUR MEASURER	381
LIQUID-DETERGENT DISPENSER	363
LOAF PAN	95, 102, 103
LOLLIPOP STICKS	124
LUNCH AWAY	274
LUNCH BOX	275, 415

M

MAGNIFYING GLASS FOR REFRIGERATOR	388
MANGO PITTEER	296
MATE SET	229
MEASURING CUP	174, 175, 381, 398
MEASURING CUPS	175
MEASURING JAR	174, 243
MEASURING SPOONS	175
MEAT NETTING	352
MEAT TENDERIZER	323, 335
MELON-PINEAPPLE SLICER	296
MILK CHUM	231, 348, 394, 399, 404
MODELING TOOL	183
MOLD FOR DARIOLE	97
MORTAR	345, 346
3D MOULD	111, 184, 185
MOULD FOR LETTERS	184
MOULDS MINI	92, 97, 102
MOULE CHOCOLATE	111, 115, 116
MUDLER	381
MUFFIN PAN	82, 85, 86, 125
MUG	393, 395, 396, 397, 400, 401, 406, 414
MUG + PLATILLO	208, 398, 402
MULTI ROLL DISPENSER	360
MUSHROOM SLICER	299
MUSSEL STOCKPOT	34

N

NAPKING HOLDER	367
NET BAG FOR LEGUMES	352
NOUGAT MOULD	118, 119, 120
NUTCRACKER	304

O

OBLONG PAN	87, 93
OIGNON HOLDER	297
OIL CAN	253, 254, 257, 258, 259, 260
OIL SPRAY	260
OIL STRAINER	255, 256
OLIVE LADLE	331, 404
OLIVIER SALAD CUTTER	292
OMELETTE HOLDER	276
OMELETTE PAN	43, 47, 50, 51, 53, 54, 59, 60
OPENER	384, 385
ORANGE PEELER	303
OVAL PLATTER	263, 266, 391, 392, 393, 397, 401, 403
OVEN GLOVE	390
OVEN PROOF PAPER	189
OVEN TONGS	310
OYSTER OPENNER	325, 351

P

PAELLA PANS	71, 72, 73
PAN PROTECTOR	66
PANCKE MOULD	123
PANDORO MOULD	92
PANETTONE MOULD	96, 102
PASTA CUTTER	139, 323
PASTA DRYING RACK	247
PASTA MACHINE	246
PASTA POT	31
PASTRY BAG HOLDER	158
PASTRY BAGS	157, 158, 159, 160
PASTRY MAT	182
PASTRY PLASTIC RIBBON	132
PEPPER CORER	294
PESTLE	268
PETIT CHOC KIT	141
PIE MINI MOULD	149
PIE MOULD	78, 80, 82, 85, 92, 95, 103, 105
PINEAPPLE SLICER	295
PITCHER	201, 209, 225, 347, 348, 394, 395, 405, 406
PIZZA CUTTER	249, 250, 325
PIZZA MOULD	78, 79, 81, 97, 102
PIZZA SCREEN	249
PIZZA STONE	248
PLATE FOR DEFROSTING	387
PLATTER	104, 105, 107, 108, 109, 266, 399, 403
PLUNGER COFFEE MAKER	199
POMEGRANATE DESEEDER	304
PORCELAIN TABLEWARE	235, 236, 237, 238
PORTION MAKER	148
POTATO MASHER	326
POTATO PEELER	301, 302, 303, 326
POURER	374, 375, 376
POWER BAR KIT	242
PRESENTATION SPOONS	365
PRESSURE COOKER	15, 16
PUMPKIN PEELER	303, 304
PUSH UP CAKE MOLD	124
PUSSER	132, 149

R

RACK	162
RACK FOR SKEWERS	358
RAMEKIN	103
RAVIOLI ATTACHMENT	246
RAVIOLI CUTTER	247, 248
RAVIOLI MOULD	248
REVOLVING CAKE STAND	162, 163
RINGS	130, 131, 132
ROAST PANS	78, 107, 108, 109, 399
ROASTING BAGS	386
ROASTING CASSEROLE	34
ROLLER DOCKER	150
ROLLING PIN	172, 336
ROLLING PIN COVER	352
ROLLING PIN FONDANT	151
ROSCOS CUTTER	145
ROSETTE MOULD	125, 126
ROUND DISH	26, 28, 32, 391, 409

S

SALAD SETS	254, 261
SALAD SPINNER	341, 342
SALT & PEPPER SET	254, 261, 262
SALT CELLAR	252, 253
SAUCE BASTER	386
SAUCE BOWL	266, 408

SAUCE PIPETTE	386
SAUCE SYRINGE	386
SAUCEPAN	20, 22, 24, 25, 26, 27, 29, 31, 32, 33, 393, 398, 400, 402
SAVARIN MOULD	78, 79, 80, 82, 85, 94, 97, 101, 103
SCISSORS	288, 289
SCOUT CANTEEN	414
SCRAPER	166, 167, 169, 170, 171, 172
SEAFOOD CRACKER	350, 351
SERVER-BASE FOR PIZZA	249
SERVING TRAY	406
SHAKER	173
SHARPENER	290, 291
SHOE MOLD	110
SHOVEL	405
SIEVE	269
SIEVE/SIFTER	173
SINK STRAINER	363, 364
SKEWERS	339, 358
SKEWERS FOR SNAILS	390
SKIMMER	243, 322, 326, 327, 328, 329, 330, 331, 332, 333, 335, 337, 394, 399, 404
SLICER	293, 297
SODA SIPHON	384
SPAGHETTI SERVER	324, 325, 327, 328, 331, 332, 335
SPAGUETTI MEASURER	247
SPATULA FOR OMELETTES	330, 334
SPATULA GRILL	331
SPATULA TAMAGOYAKI	57
SPATULA-SCRAPER	166, 167, 168, 323
SPATULES	168, 169, 323, 324, 325, 327, 328, 329, 330, 331, 332, 333, 337, 338
SPHERE MOULD	112
SPONGE CAKE PAN	95, 179
SPOON	168, 169, 324, 325, 327, 328, 329, 331, 332, 333, 335, 336, 337, 338, 399, 404
SPOON PEN	365
SPOUT	387
SPRAY (MOULD GREASING)	190
SPRINGFORM	77, 79, 81, 88, 89, 90, 95, 98, 101
SPRINGFORM WITH GLASS BASE	83
SQUARE MOULD	78, 94
SQUEEZE BOTTLE	161
STAMPS	148, 185
STAND	74, 240, 417
STEAM BASKET	25, 36, 242, 245
STEAM CASE	241
STEAM CASSEROLE	25
STEAMER	245
STEAMER PAPER	245
STEWING PAN	46
STOCK POT	20, 21, 24, 25, 29, 31, 33, 398, 402
STONE GRILL	357, 358
STOPPERS FOR VACUUM PUMP	372, 373
STRAINER	267, 268, 360, 394, 399, 403
STRAINER FOR PASTA/ASPARRAGUS	36
STRAWS	231
STRIPES ROLLER	182
SUGAR BOWL	262, 396
SUPPORT	130
SUPPORT FOR KNIVES	291
SUSHI MAKER	245

T

TABLE BIN	364
TABLEMAT	367
TACO HOLDER	246
TAMAGOYAKI PAN	57
TART MOLD	80
TART MOULD	78, 80, 81, 82, 85, 86, 87, 90, 94, 97, 105
TEA BALLS	210

TEA CUP	228, 398, 400, 402
TEA GLASS	228
TEA POT	200, 201, 202, 203, 204, 205, 206, 207, 395, 396, 400
TEAPOT TRIVET	207
TEAPOT WARMER	208
TEDDY BEAR PAN	96, 124
THERMOCAN	222
THERMOMETER	117, 118, 320, 321, 377
THERMOS	223, 224, 225, 226
TIMER	368
TIN OPENER	324, 349, 385
TOMATO CORER	326
TOMATO PEELER	302, 326
TONGS	170, 307, 308, 309, 310, 334, 337, 367
TOOL STAND WITH SPOON	358, 359
TOOLS STAND	329, 333
TORCHS	128, 129
TORTILA WARMERL	246
TORTILLA PRESS	246
TORTOISE MOLD	112
TRUNK MOLD	94
TRUSSING NEEDLE	351
TUBE CLEANING BRUSH	156
TUMBLER	414
TURKISH COFFEE POT	396

U

UTENSILS FOR CHOCOLATE CANDY	116
------------------------------	-----

V

VACUUM MUG	220, 221, 223
VACUUM SINE SABER	372, 373, 375
VEGETABLE SAVER	278
VEGETABLE SHARPENER	293
VEGETABLES BRUSH	364
VITROCERAMIC SCRAPER	364

W

WAFFLE MAKER	126
WALL RACK	340, 404
WASH BOWL	394, 395, 400, 405
WATERMELON CORER&SERVER	295
WHIPPER'S CHARGES (CREAM)	134
WHIPPER'S CHARGES (SODA)	384
WHIPPER'S CLEANING SPONGE	230
WHIPPERS	133, 134
WHISK	170, 171, 172, 231, 324
WHISTLING KETTLE	200
WINE AREATOR	375, 377
WINE SET	375
WINE TAGS	377
WIRE GRILL	355, 356, 357
WOK	40, 41, 42, 43, 46, 47, 53, 58, 59, 62
WOOD	334, 335, 336, 379

Y

YOLK SEPARATOR	354
----------------	-----

Table d'es matières.



A

ACCESOIRE À RAVIOLI	246
ACUMULATEUR DE FROID	413
ADAPTATEUR DE CHALUMEAU	129
ADAPTATEUR INDUCTION- VITROCÉRAMIQUE	35, 198
ADAPTATEURS	157
AERATEUR DE VIN	375, 377
AIGUILLE À BRIDER	351
AIGUILLE À LARDER	325
AIGUISEUR	290, 291
ALLUME GAZ	389
ANNEAU ANTI-GOUTTE	376
ANNEAUX PER LIVELLARE	182
ANTI-CALCAIRE POUR THÉIÈRES	229
APPAREIL POUR TORTILLAS	246
ASSIETTE	338, 391, 393, 396, 397, 398, 401, 402, 414
ATTENDRISEUR À VIANDE	323, 335

B

BAGUETTES	339
BAIN MARIE	117
BALANCE DE CUISINE	164
BANNETON	104
BARQUETTES À PÂTISSERIE	176, 177, 178, 179
BASE	187
BATTERIES	26
BEC VERSEUR	374, 375, 376
BEURRIER AVEC COUVERCLE	253, 366, 399, 404
BIDON À LAIT	231, 348, 394, 399, 404
BILLES POUR DÉCANTEUR	377
BILLES POUR PÂTISSERIE	173
BOIS	334, 335, 336, 379
BOUCHONS POUR POMPE À VIDE	372, 373
BOUCHONS VERSEURS	373, 374, 375, 376, 377
BOUGIES D'ANNIVERSAIRE	164, 165
BOUILLOIRE SIFFLANTE	200
BOUILLOIRES	199, 396
BOULE POUR POT-À-FEU	353
BOULE À GLACES	123, 325
BOULES À THÉ	210
BOUTEILLE	212, 213, 214, 215, 216, 217, 218, 219, 220, 226, 227
BOUTEILLE ISOTHERME	223, 224, 225, 226
BOÎTE	119, 182, 229
BOÎTE ALIMENTAIRE	271, 272, 273, 274, 275, 276, 277
BOÎTE À OEUF	360
BOÎTE À PAIN	250, 251, 405
BOÎTE À SAUPOUDRER	173
BOÎTE À TORTILLA	276
BOÎTE À ÉPICES	362
BROCHETTES	339, 358
BROSSE POUR NETTOYER LES CASSEROLES	363
BROSSE À BOUTEILLES	230
BROSSE À DOUILLE	156
BROSSE À LAVER LÉGUMES	364
BRÛLEUR	130
BÂTONS POUR SUCETTES	124

C

CAFETIÈRE CONIQUE	394, 395, 396, 400, 406
CAFETIÈRE EMBOLO	199
CAFETIÈRE EXPRESSO	193, 194, 195, 196, 197, 198
CAFETIÈRE TURCQUE	396
CANETTE ISOTHERME	222

CASSE-NOIX	304
CASSEROLE	20, 22, 24, 25, 26, 27, 29, 31, 32, 33, 393, 398, 400, 402
CASSEROLE POUR PÂTES	31
CASSEROLES È MESURER	175
CERCLES	130, 131, 132
CHALUMEAUX	128, 129
CHARGES POUR SIPHON (CRÈME)	134
CHARGES POUR SIPHON (SODA)	384
CHAUFFE-THÉIÈRES	208
CHAUFFE-TORTILLAS	246
CISEAUX	288, 289
CLIP	362
CLOCHE ALIMENTAIRE	317
COCOTTE	30, 33, 399, 400
COCOTTE À PRESSION	15, 16
COFFRET VAPEUR	241
COFFRET À VIN	375
COMPACTEUR DE BOÎTES	388
CONSERVATEUR DE FRUITS	270
CONSERVATION DE LÉGUMES	278
CONTENANT ALIMENTAIRE	278, 280, 281
COQUETIER	367
COUPE CHÂSTAIGNES	303
COUPE FROMAGE	297
COUPE POMMES DE TERRE	292, 293, 294
COUPE SALADE RUSSE	292
COUPE À FRUITS	399, 405
COUPE-FOIE-GRAS	297
COUPE-FROMAGES	297, 325
COUPE-OEUF	298
COUPE-PÂTE	126, 136, 137, 139, 140, 141, 142, 143, 144, 145, 146, 147, 185, 186, 187
COUPE-PÂTE RAVIOLI	247, 248
COUPEUR DE LÉGUMES	293, 297
COUPEUR-SERVEUR À PASTÈQUE	295
COUPEUSE EN LAMELLES	299
COUTEAU	284, 285, 286, 287
COUTEAU POUR FONDANT	182
COUTEAU À FROMAGE	287, 324
COUTEAU À HÛITRES	325, 351
COUTEAU-SPATUYLE POUR LE BEURRE	287, 326
COUVERCLE	314, 315, 316, 317
COUVERCLE EN VERRE AVEC FOND	317
COUVERCLE PER MICROONDE	317
COUVERCLE POUR MOULE À FLAN	98
COUVERTS	275, 282, 283, 415
CPASULES POUR DUPCAKE	160, 178, 179, 180
CRAYON À DÉCORER	161
CRÉMIÈRE	396
CUILLÈRE	168, 169, 324, 325, 327, 328, 329, 331, 332, 333, 335, 336, 337, 338, 399, 404
CUILLÈRE PLUME	365
CUILLÈRE À COCKTAIL	380
CUILLÈRE À GLACE	122, 123
CUILLÈRE À MESURER	175
CUILLÈRE À SPAGHETTI	324, 325, 327, 328, 331, 332, 335
CUILLÈRES DE PRÉSENTATION	365
CUILLÈRE SPHÉRIQUES	366
CUISEUR POUR PÂTES ET ASPERGES	36
CUISEUR VAPEUR	245
CUIT-ASPERGES	25
CUVETTE	394, 395, 400, 405

D

DECÒ LÉGUMES	298
--------------	-----

DESSOUS ASSIETTE	366	GAZ	129, 130
DESSOUS DE PLAT	367	GIDE COUPE-GÂTEAU	152
DIFFUSEUR POUR GAZINIÈRES	35	GIROLLE À FROMAGE	116
DISTRIBUTEUR DE CAPSULES	211	GOBELET	393, 395, 396, 397, 400, 401, 406, 414
DISTRIBUTEUR DE D'EAU	388	GOBELET + ASSIETTE	208, 398, 402
DISTRIBUTEUR DE DÉTERGENT LIQUIDE	363	GOURDE	414
DISTRIBUTEUR FILM/PAPIER	360	GRILL	41, 43, 44, 46, 48, 49, 50, 53, 55, 58
DISTRIBUTEURS DE CONDIMENTS	275	GRILL GAZ	67
DOSEUR DE LIQUEUR	381	GRILLE	162
DOSEUR À MIEL	262	GRILLE PAIN	66
DOUILLES	153, 154, 155, 156, 160	GRILLE POUR PIZZA	249
DÉCAPSULER	384, 385	GRILLE POUR ÉVIER	363, 364
DÉCAPSULEUR	323, 372, 385		
DÉCORATEURS	149, 160, 161, 162, 229	H	
DÉCOUPOIR À BEIGNETS	145	HACHOIR	305, 306
DÉCOUPOIRS	138, 149	HACHOIR DE L'AIL	302, 306
DÉNOYATEUR À MANGUE	296	HACHOIR RAPIDE	305
DÉNOYAUTEUR À CERISES	296	HALLOWEEN	91
		HUILIER	253, 254, 257, 258, 259, 260
E			
ECO	415, 416		
ECUMOIRE	243, 322, 326, 327, 328, 329, 330, 331, 332, 333, 335, 337, 394, 399, 404	I	
EFFILEUR POUR HARICOTS	301	IDENTIFICATEURS DE VERRES	377
EGOUTTOIR À COUVERTS	340	INFUSEUR	209
ELIMINATEUR DE GRAISSE	243		
EMBALLAGE DE CUPCAKES	179	K	
EMPORTE-PIÈCE DE CHEBAKIA	140	KIT PETIT CHOC	141
ENSEMBLE À MATÉ	229	KIT POUR CROQUETTES	127
ENTONNOIR	346, 347, 405	KIT À BARRES ÉNERGÉTIQUES	242
ENTONNOIR POUR CONFITURES	346	KIT À CHARCUTERIE	242
EPLUCHEUR DE POMMES	301		
EPLUCHEUR À ASPARGUES	301	L	
EPLUCHEUR À CITROUILLES	303, 304	LAME POUR ENTAILLER LE PAIN	250
ESSOREUSE À SALADE	341, 342	LAMINEUR AIL	299
ÉGOUTTOIR À ASSIETTES	360	LOUCHE	322, 323, 325, 327, 328, 329, 330, 331, 332, 333, 394, 399, 404
ÉCAILLEUR À POISSON	303	LOUCHE À BEIGNETS	125
ÉPLUCHEUR À LEGUMES	301, 302, 303, 326	LOUCHE À OLIVES	331, 404
ÉPLUCHEUR À TOMATE	302, 326	LOUPE POUR RÉFRIGÉRATEUR	388
ÉPLUCHEUR À LEGUMES	301, 302, 303, 326	LUNCH AWAY	274
ÉPLUCHE-AIL	302	LUNETTES	298
ÉPONGE EN ÉMERI	363	LYRE À GÉNOISE	148
ÉPLUCHEUR À TOMATE	302, 326		
ÉPLUCHE-ANANAS	295	M	
ÉTIQUETES POUR VIN	377	MACHINE DE CAPSULES CAFÉ	230
ÉVIDEUR À POIVRONS	294	MACHINE À CHURROS	135, 136
ÉGRENEUSE À GRENADES	304	MACHINE À CROQUETTES	127
ÉPLUCHEUR D'ORANGES	303	MACHINE À DONUTS	136
	244	MACHINE À PÂTE	246
ÉPONGE NETTOYANT	230	MANDOLINE	299, 300
		MARMITE	20, 21, 24, 25, 29, 31, 33, 398, 402
F		MARMITE À MOULES	34
FAITOUT	17, 18, 19, 20, 22, 24, 25, 28, 29, 31, 33, 402	MARQUEUR	148, 185
FAITOUT CUIT VAPEUR	25	MARQUEUR À GATEAUX	148
FAITOUT FOUR	34	MESURE À SPAGUETTI	247
FEUILLE DE CUISSON	190	MINUTERIE	368
FIL DE CUISINE	351	MORTIER	345, 346
FILET ÉLASTIQUE	352	MOULDE POUR TARTA "PIE"	149
FILTRES	208, 209, 210, 353	MOULDE À GLACE	121, 122
FLACON VERSEUR SOUPLE	161	MOULE "PASTEL DE NATA"	101
FONDUE	243	MOULE 3D	111, 184, 185
FOUET	170, 171, 172, 231, 324	MOULE ANGEL FOOD	101
FOURCHETTE	324, 328, 329, 338	MOULE ANODIZADO	188, 189
FRILL PIERRE	357, 358	MOULE BAS	80
FRITEUSE AVEC PANIER	28, 55, 57, 59, 61	MOULE BONBONS	113, 114, 115, 116
		MOULE CANNELÉ	97
G		MOULE CARRÉ	78, 94
GANT	390		

MOULE CHAUSSURE	110	PAILLES	231
MOULE CHOCOLAT	111, 115, 116	PANIER POUR LE PAIN	251
MOULE CONFISERIES	123	PANIER VAPEUR	25, 36, 242, 245
MOULE DOUGHNUT	83, 92	PANIER À NID	366
MOULE DÉMONTABLE	77, 79, 81, 88, 89, 90, 95, 98, 101	PANIER À OEUFS	360
MOULE DÉMONTABLE AVEC BASE EN VERRE	83	PANIERS	66, 366
MOULE EN FORME DE LETTRES	184	PAPIER CUISSON	189
MOULE FORME COEUR	77, 95, 98, 111, 112	PAPIER POUR PANIER VAPEUR	245
MOULE FORME PETIT OURS	96, 124	PAPIER À STEAK HACHÉ	343
MOULE GINGER	111	PASSOIR À COULIS	269
MOULE HAUT	78, 80, 82, 85, 92, 95, 103, 105	PASSOIRE	209, 267, 268, 404
MOULE KOUGLOF	94	PASSOIRE COCKTAIL	380
MOULE OEUF DE PÂQUES	95, 112	PASSOIRE À OEUF	161
MOULE PANDORO	92	PELLE	405
MOULE POUR CAKE POPS	124	PELLE À FARINE	365
MOULE POUR PANCAKES	123	PELLE À PIZZA	249
MOULE PUSH UP CAKE	124	PELLE À POISSON	324, 335
MOULE RAVIOLIS	248	PELLE À TARTE	172, 324
MOULE RECTANGULAIRE	87, 93	PENDERIE MURALE	340, 404
MOULE SAC	111	PERCEUR D'OEUFS	298
MOULE SEMIESPHERE	100	PIERRE POUR PIZZA	248
MOULE SPHERE	112	PILEUR À GLACE	384
MOULE TORTUE	112	PILON À COCKTAILS	381
MOULE TOURON	118, 119, 120	PINCE	307
MOULE TRONC	94	PINCE POUR FOUR	310
MOULE À ASPIC	96	PINCE POUR PLATS	310
MOULE À BOULES	161, 296, 325	PINCE À BOCAUX	310
MOULE À BÛCHE	100, 112	PINCE À FRUIT DE MER	350, 351
MOULE À CAKE	77, 79, 80, 82, 84, 85, 87, 90, 95, 97, 99, 101, 102, 103, 105	PINCEAU	168, 169, 170, 172, 173, 183, 324
MOULE À CHAUSSONS	126, 127	PINCES	170, 307, 308, 309, 310, 334, 337, 367
MOULE À CIGARETTE	96, 99, 100	PINCES POUR FONDAN	149, 183
MOULE À CRÈME CARAMEL	79, 80, 81, 82, 84, 85, 90, 93, 94, 98, 99, 101, 105, 124, 398, 405	PIPETTE POUR SAUCES	386
MOULE À DARIOLE	97	PIQUE DÉCOUPE-OIGNONS	297
MOULE À FALAFEL	244	PIQUES À ESCARGOTS	390
MOULE À GAUFRE	126	PLANCHE À DECOUPER	318, 319, 320
MOULE À MADELAINE	95, 179	PLANCHE À GNOCCI	247
MOULE À OEUF	96, 126	PLANCHES À NIVELER	183
MOULE À PAIN	95, 102, 103	PLAQUE BAGUETTE	93, 99
MOULE À PANETTONE	96, 102	PLAQUE DÉCOUPOIR CROSTATA	150
MOULE À PIZZA	78, 79, 81, 97, 102	PLAQUE NÔEL	77, 92
MOULE À ROSACE	125, 126	PLAQUE POU DÉCONGELER	387
MOULE À SAVARIN	78, 79, 80, 82, 85, 94, 97, 101, 103	PLAQUE À BISCUITS	78, 87, 94
MOULE À STEAK HACHÉ	343, 344	PLAQUES CAVITÉS	82, 85, 86, 125
MOULE À SUSHI	245	PLAT	104, 105, 107, 108, 109, 266, 399, 403
MOULE À TARTE DENTELÉ	78, 80, 81, 82, 85, 86, 87, 90, 94, 97, 105	PLAT EN FONTE DE FER	67
MOULE ÉXTENSIBLE	100	PLAT OVAL	263, 266, 391, 392, 393, 397, 401, 403
MOULES GLAÇONS	382, 383	PLAT ROND	26, 28, 32, 391, 409
MOULES MINI	92, 97, 102	PLAT À "EMSPANADA"	100
MOULES PRALINÉS	178, 179	PLAT À OEUF	407
MOULES À GELÉE	124	PLATEAU DE SERVICE	406
MOULIN POUR CAFFÈ	210	PLATEAU TOURNANT	162, 163
MOULIN RÂPE	294, 313, 344, 345	PLATS À PAËLLA	71, 72, 73
MUG ISOTHERME	220, 221, 223	PLATS À RÔTIR	78, 107, 108, 109, 399
		POCHES À DÉCORER	157, 158, 159, 160
		POCHEUSE À OEUF	95, 241
		POIGNÉES	20, 43, 74, 316
		POIRE À SAUCE	386
		POIVRIÈRE-SALIÈRE	254, 261, 262
		POMPE À VIDE	372, 373, 375
		PORTE-USTENSILES DE CUISINE	339, 340
		PORTE-GÂTEAUX	163
		PORTE-SERVIETTES	367
		PORTE-TORCHONS	361
		POT	231, 252, 278, 279, 280
		POT CILINDRIQUE	28, 31, 201, 403
		POT DE CHAMBRE	394, 395, 400, 406
		POT POUR L'AIL	252
		POT À EAU	201, 209, 225, 347, 348, 394, 395, 405, 406
		POT À HUILE	255, 256
		POUBELLE DE TABLE	364
		POUBELLE POUR SÉLETIF	364
		POUSSOIR	268

N

NAPPERONS 180, 181

O

ORGANISATEUR DE CANETTES 359
 ORGANISATEUR DE TIROIR 359, 360
 OUTILS POUR FONDANT 183
 OUVRE-BOCAUX 325, 349, 350
 OUVRE-BOÎTES 324, 349, 385

POÊLE	39, 40, 41, 42, 45, 46, 47, 49, 50, 51, 52, 54, 55, 56, 57, 58, 59, 60, 63, 64, 65, 398, 403
POÊLE PROFONDE	40, 47, 49, 51, 52, 53, 55, 56, 57, 65
POÊLE À BLINIS	61
POÊLE À CRÊPES	41, 48, 53, 55, 57, 59, 62
POÊLE À MARRONS	62
POÊLE À OMELETTE	43, 47, 50, 51, 53, 54, 59, 60
POÊLE À POISSON	59
POÊLE À TAMAGOYAKI	57
PRESENTOIR	74, 240, 417
PRESSE PURÉE	326
PRESSE À HAMBURGER	343
PRESSE-AIL	306, 323
PRESSE-FRUITES	342, 379, 380
PROTECTEUR DE DOIGTS	297
PROTECTION POUR POÊLES	66
PUPITRE	361

R

RACLETTE	149, 166, 167, 168
RACLOIR VITROCERAMIQUE	364
RAMASE MIETTES	361, 362
RAMEQUIN	103
RAMSASSE LÉGUMES/HERBES	298
RAVIER	366
RECIPIENT DEMI-SPHÉRIQUE	117, 264
REFRAÎCHISSEUR À BOUTEILLES	377, 378, 379
REFROIDISSEUR DE CANETTES	378
REPOSE USTENSILES	358, 359
ROULEAU COUPEUR DE CROISSANT	150
ROULEAU FONDANT	151
ROULEAU MILLERAIES	182
ROULEAU PICKE VITE	150
ROULEAU À LOSANGE	150
ROULEAU À PÂTISSERIE	172, 336
ROULETTE COUPE-PÂTES	139, 323
ROULETTE À PIZZA	249, 250, 325
RUBAN PVC PÂTISSIER	132
RÂPE	311, 312, 313, 324, 326
RÂPE A CITRON	325
RÉCIPENT POUR FRITEUSE À AIR	106
RÉCIPIENT POUR SAUCES	266, 408
RÔTISSOIRE À POULET	386

S

SAC ISOTHERME	410, 411, 412, 413
SAC POUR LAIT VÉGÉTAL	353
SAC À JAMBON	353
SAC À LÉGUMES	352
SAC À LÉGUMES	352
SAC À PAIN	251
SACHETS GRILL	387
SACS DE CUISSON	386
SALADIER	239, 263, 264, 265, 393, 397, 398, 401, 402, 403
SALIÈRE	252, 253
SAUCIÈRE	253, 366
SAUPOUDREUSE À FROMAGE	262
SAUTEUSE	46
SEAU	379, 394, 396, 398, 400, 404, 405, 409
SEAU À CHAMPAGNE	379
SEAU À GLACE	379
SECTIONNEUR À CITRONS	294
SECTIONNEUR À POMMES	296
SERINGUE À SAUCE	386
SERRE-JAMBON	337
SECTIONNEUR À MELON-ANANAS	296
SHAKER	380
SIPHON À SODA	384
SIPHONS	133, 134

SOUVRE-ROULEAUX	352
SPATULE	168, 169, 323, 324, 325, 327, 328, 329, 330, 331, 332, 333, 337, 338
SPATULE À PÂTISSERIE	166, 167, 169, 170, 171, 172
SPATULE PLANCHA	331
SPATULE POUR OMELETTES	330, 334
SPATULE TAMAGOYAKI	57
SPATULE À CRÊPES	172, 330, 336
SPATULE-RACLOIR	166, 167, 168, 323
SPRAY DÉMOULANT	190
SUCRIER	262, 396
SUPPORT	130
SUPPORT PIED	329, 333
SUPPORT POUR BROCHETTES	358
SUPPORT POUR COUTEAUX	291
SUPPORT POUR CUPCAKE	163
SUPPORT POUR POCHE À DECORER	158
SUPPORT POUR TACOS	246
SUPPORT POUR THÉIERE	207
SÉCHOIR À PÂTES	247
SÉPARATEUR À OEUF	354

T

TAILLE-POINTE POUR LÉGUMES	293
TAMIS	173
TAMIS À FARINE À GLISSIÈRE	269
TAPIS FOUR	85, 189
TAPIS À PÂTISSERIE	182
TAPIS ÉGOUTTOIR	361
TASSE	239, 414
TASSE À TÉ	228, 398, 400, 402
TESTEUR DE CUISSON	172
THERMOMÈTRE	117, 118, 320, 321, 377
THÉIERE	200, 201, 202, 203, 204, 205, 206, 207, 395, 396, 400
TIMBALE	414
TIRE-BOUCHON	369, 370, 371, 372
TIRE-BOUCHON À CHAMPAGNE	372
TISSU	352
TRANCHE-AVOCATS	299

U

USTENSILES POUR CHOCOLATINES	116
------------------------------	-----

V

VAISSELLE EN PORCELAINE	235, 236, 237, 238
VAPORISATEUR D'HUILE	260
VERRE MESURER	174, 243
VERRE À GLACES	122
VERRE À THÉ	228
VIDE-POMMES	295, 323
VIDE-TOMATE	326
VINAIGRIERS	254, 261

W

WOK	40, 41, 42, 43, 46, 47, 53, 58, 59, 62
-----	--



A

ABRE-BOIÕES	325, 349, 350
ABRE-LATAS	324, 349, 385
ABRE-OSTRAS	325, 351
ABRIDOR DE CHAMPANHE	372
ABRIDOR DE CÁPSULAS	384, 385
ACCESSÓRIO PARA RAVIOLI	246
ACUMULADOR DE FRIO	413
ADAPTADOR INDUÇÃO-VITROCÉRAMICA	35, 198
ADAPTADOR PARA MAÇARICO	129
ADAPTADORES	157
AFIADOR	290, 291
AGULHA DE COZINHA	351
AGULHA PARA RECHEAR	325
ALMOJARIZ	345, 346
ALMOTOLIA	253, 254, 257, 258, 259, 260
AMACIADOR DE CARNE	387
AMASADOR DE BATATA	326
ANEL ANTI-GOTA	376
ANILHAS NIVELADORAS	182
APANHA-MIGALHAS	361, 362
APANHADOR	405
APROVEITADOR DE AZEITE	255, 256
AQUECEDOR PARA BULES	208
AREJADOR DE VINHO	375, 377
AROS	130, 131, 132
ARREFECEDOR DE LATAS	378
ARREFEDOR DE GARRAFAS	377, 378, 379
ASSADOR DE FRANGO	386
ATRIL	361
AZEITERA SPRAY	260
AÇUCAREIRO	262, 396

B

BACIA	394, 395, 400, 405
BACIO	394, 395, 400, 406
BALANÇA DE COZINHA	164
BALDE	379, 394, 396, 398, 400, 404, 405, 409
BALDE CHAMPANHE	379
BALDE GELO	379
BALDE PARA RECICLAGEM	364
BANDEJA	104, 105, 107, 108, 109, 266, 399, 403
BANDEJA DE SERVIÇO	406
BANHO MARIA	117
BANNETON	104
BASE	187
BASTONCINIPER LECCA-LECCA	124
BATEDOR	170, 171, 172, 231, 324
BICO VERTEDOR	387
BOLAS PARA PASTELARIA	173
BOMBA DE VÁCUO	372, 373, 375
BOQUILHAS	153, 154, 155, 156, 160

C

CAFETEIRA COM APITO	200
CAFETEIRA CONICA	394, 395, 396, 400, 406
CAFETEIRA EMBOLO	199
CAFETEIRA EXPRESSO	193, 194, 195, 196, 197, 198
CAFETEIRA TURCA	396
CAIXA	119, 182, 229
CAIXA PARA OVOS	360
CAIXA PARA PÃO	250, 251, 405

CAIXA PARA RESIDUOS	364
CANECA	393, 395, 396, 397, 400, 401, 406, 414
CANECA A VÁCUO	220, 221, 223
CANECA COM PTRATO	208, 398, 402
CANTIL	414
CAPA PARA ROLO DE AMASAR	352
CARGAS PARA SIFÃOS (NATAS)	134
CARGAS PARA SIFÃOS (SODA)	384
CAÇAROLA	20, 22, 24, 25, 26, 27, 29, 31, 32, 33, 393, 398, 400, 402
CAÇAROLA BAIXA	46
CAÇAROLAS MEDIDORAS	175
CENTRIFUGA PARA SALADA	341, 342
CEPILLO PARA VERDURAS	364
CESTA PARA PÃO	251
CESTO PARA OVOS	360
CESTO VAPOR	25, 36, 242, 245
CESTOS DE FRITADEIRA	66, 366
CHALEIRA	199, 396
CHÁVENA DE CHÁ	228, 398, 400, 402
CLIPE	362
COADOR	269
COADOR COCKTAIL	380
COADOR FIO DE OVOS	161
COCOTTE	30, 33, 399, 400
COLHER	168, 169, 324, 325, 327, 328, 329, 331, 332, 333, 335, 336, 337, 338, 399, 404
COLHER CANETA	365
COLHER COCKTAIL	380
COLHER DE GELO	123, 325
COLHER MEDIDORA	175
COLHER PARA AZEITONAS	331, 404
COLHER PARA ESFERIFICAÇÕES	366
COLHER PARA ESPARGUETTE	324, 325, 327, 328, 331, 332, 335
COLHER PARA SONHOS	125
COLHERES PARA PRESENTAÇÃO	365
CONCHA	322, 323, 325, 327, 328, 329, 330, 331, 332, 333, 394, 399, 404
CONJUNTO PARA MATE	229
CONSERVADOR DE FRUTAS	270
COPO	414
COPO DE CHÁ	228
COPO MEDIDOR	174, 243
COPOS DE HELADO	122
CORREDOR	365
CORTA MASSAS	138, 149
CORTA-MASSAS	126, 136, 137, 139, 140, 141, 142, 143, 144, 145, 146, 147, 185, 186, 187
CORTA-OVOS	298
CORTADOR DE BATATAS	292, 293, 294
CORTADOR DE BOLOS	148
CORTADOR DE CHEBAKIA	140
CORTADOR DE FOIE-GRAS	297
CORTADOR DE LIMAOS	294
CORTADOR DE MELANCIA	295
CORTADOR DE MELÃO	161, 296, 325
CORTADOR DE MELÃOS-ANANÁS	296
CORTADOR DE QUEIJO	297
CORTADOR DE ROSCAS	145
CORTADOR DE SALADA RUSSA	292
CORTADOR DE VERDURAS	293, 297
CORTADOR EM APARAS	116
CORTADOR PARA MAÇAS	296
CORTADOR TARTA LOSANGOS	150
CORTADORES DE VERDURAS	298
CORTAMASSAS RAVIOLI	247, 248
CORTAPIZZA	249, 250, 325
COZEDOR PARA MASSA E ASPARGOS	36

CÁPSULA BOMBONEIRA	178, 179
CÁPSULA MADALENA	176, 177, 178, 179
CÁPSULAS PARA CUPCAKE	160, 178, 179, 180

D

DECORADORES	149, 160, 161, 162, 229
DESCALCIFICADOR DE BULES	229
DESCANSO DE PRATO	367
DESCANSO PARA CHALEIRAS	207
DESCAPSULADOR	323, 372, 385
DESCAROÇADOR	295, 323
DESCAROÇADOR CERESA	296
DESCAROÇADOR DE ANANAS	295
DESCAROÇADOR DE MANGA	296
DESCAROÇADOR PARA TOMATE	326
DESCASCADOR DE ABÓBORA	303, 304
DESCASCADOR DE ALHO	302
DESCASCADOR DE BATATAS	301, 302, 303, 326
DESCASCADOR DE CASTANHAS	303
DESCASCADOR DE ESPARGOS	301
DESCASCADOR DE FEIJAO	301
DESCASCADOR DE LARANJAS	303
DESCASCADOR DE TOMATE	302, 326
DESCASCADOR DE MAÇÃS	301
DIFUSOR PARA GÁS	35
DISPENSADOR DE CONDIMENTO	275
DISPENSADOR DE DETERGENTE	363
DISPENSADOR DE FILME/PAPEL	360
DISPENSADOR DE ÁGUA	388
DISTRIBUIDOR DE CAPSULAS	211
DONUTEIRA	136

E

ECO	415, 416
ELIMINATORE DI GRASSO	243
ENVOLTORIOS DE CUPCAKES	179
ESCALFADOR DE OVOS	95, 241
ESCANÇAO	374, 375, 376
ESCOADOR DE ERVAS	267, 268, 360, 394, 399, 403
ESCORREDOR DE PRATOS	360
ESCORREDOR DE TALHERES	340
ESCOVA LIMPA BOQUILHAS	156
ESCOVA LIMPADORA PARA PANEAS	363
ESCOVILHÃO LIMPA GARRAFAS	230
ESCUMADEIRA	243, 322, 326, 327, 328, 329, 330, 331, 332, 333, 335, 337, 394, 399, 404
ESFERA PARA COZIDOS	353
ESFERAS PARA DECANTADOR	377
ESPATULA PARA CREPES	172, 330, 336
ESPATULA PARA OMELETAS	330, 334
ESPATULA RASPADOR	166, 167, 168, 323
ESPETOS	339, 358
ESPONJA DE ESMERIL	363
ESPONJA DE LIMPEZA	230
ESPREMEDOR	342, 379, 380
ESPÁTULA	168, 169, 323, 324, 325, 327, 328, 329, 330, 331, 332, 333, 337, 338
ESPÁTULA PASTELARIA	166, 167, 169, 170, 171, 172
ESTECAS	183
ESTOJO PARA COZEDURA	241
ESTREMEDOR DE ALHOS	306, 323
ETIQUETAS PARA VINHO	377
EXPOSITOR	74, 240, 417

F

FACA	284, 285, 286, 287
FACA MARCADORA PARA PÃO	250
FACA PARA FONDANT	182

FACA PARA QUEIJO	287, 324
FACA PARA QUEIJOS	297, 325
FACA-ESPÁTULA PARA MANTEIGA	287, 326
FERVEDOR	28, 31, 201, 403
FILTROS	208, 209, 210, 353
FIO DE COZINHA	351
FOLHA DE COZINHA	190
FONDUE	243
FORMA 3D	111, 184, 185
FORMA ACANALADA	97
FORMA ANGEL FOOD	101
FORMA ANODIZADA	188, 189
FORMA ASPIC	96
FORMA BOLSO	111
FORMA BOMBOM	113, 114, 115, 116
FORMA BUNDT	94
FORMA COM LETRAS	184
FORMA CORAÇÃO	77, 95, 98, 111, 112
FORMA DE BOLO ALTA	78, 80, 82, 85, 92, 95, 103, 105
FORMA DE BOLO BAIXA	80
FORMA DE BOLO INGLÊS	77, 79, 80, 82, 84, 85, 87, 90, 95, 97, 99, 101, 102, 103, 105
FORMA DE PIZZA	78, 79, 81, 97, 102
FORMA DE PUDIM FLAN	79, 80, 81, 82, 84, 85, 90, 93, 94, 98, 99, 101, 105, 124, 398, 405
FORMA DE PÃO	95, 102, 103
FORMA DE ROLITOS	96, 99, 100
FORMA DE TARTE CANELADA	78, 80, 81, 82, 85, 86, 87, 90, 94, 97, 105
FORMA DESMONTÁVEL	77, 79, 81, 88, 89, 90, 95, 98, 101
FORMA DESMONTÁVEL COM BASE DE VIDRO	83
FORMA DOUGHNUT	83, 92
FORMA ESFERA	112
FORMA EXTENSÍVEL	100
FORMA GINGER	111
FORMA GOMAS	123
FORMA HAMBURGUER	343, 344
FORMA MADALENA	95, 179
FORMA NINHO	366
FORMA OVO DE PÁSCOA	95, 112
FORMA PANDORO	92
FORMA PARA CAKE POPS	124
FORMA PARA DARIOLE	97
FORMA PARA GOFRES	126
FORMA PARA ROSÁCEA	125, 126
FORMA PARA SALGADOS	126, 127
FORMA PASTEL DE NATA	101
FORMA PUSH UP CAKE	124
FORMA QUADRADA	78, 94
FORMA RECTANGULAR	87, 93
FORMA SAPATO	110
FORMA SAVARIN	78, 79, 80, 82, 85, 94, 97, 101, 103
FORMA SEMIESFERA	100
FORMA TATARUGA	112
FORMA TRONCO NATAL	100, 112
FORMA URSINHO	96, 124
FORMAS GELATINA	124
FORMAS MINI	92, 97, 102
FRASCO PARA ALHOS	252
FRITADEIRA COM CESTO	28, 55, 57, 59, 61
FRUTERO	399, 405
FUNIL	346, 347, 405
FUNIL PARA COMPOTAS	346

G

GALHETEIROS	254, 261
GARFO	324, 328, 329, 338
GARFOS PARA CARACÓIS	390
GARRAFA	212, 213, 214, 215, 216, 217, 218, 219, 220, 226, 227
GRELHA	355, 356, 357
GRELHADOR	41, 43, 44, 46, 48, 49, 50, 53, 55, 58

GRELHADOR PEDRA	357, 358
GRILL GAS	67
GRLHA PARA BANCA	363, 364
GUARDA LEGUMES	278
GUIA CORTA-PÃO-SW-LÓ	152
GUÍA CORTACEBOLAS	297
GÁZ	129, 130

H

HALLOWEEN	91
-----------	----

I

IDENTIFICADORES DE TAÇAS	377
INFUSOR	209
INJECTOR DE MOLHOS	386
ISQUEIROS	389

J

JARRA DE MEL	262
JARRO	201, 209, 225, 347, 348, 394, 395, 405, 406
JOGO PARA VINHO	375

K

KIT PARA BARRAS ENERGETICAS	242
KIT PARA CROQUETES	127
KIT PARA FIAMBRE	242
KIT PETIT CHOC	141

L

LAMINADOR ALHOS	299
LAMINADOR DE ABACATE	299
LANCHEIRA	275, 415
LANCHEIRAS	271, 272, 273, 274, 275, 276, 277
LEITEIRA	231, 348, 394, 399, 404
LOIÇA DE PORCELANA	235, 236, 237, 238
LUNCH AWAY	274
LUPA PARA FRIGORIFICO	388
LÁPIS PARA DECORAR	161

M

MADEIRA	334, 335, 336, 379
MANDOLINA	299, 300
MANOPLA	390
MANTEIGUEIRA COM TAMPA	253, 366, 399, 404
MAQUINA DE CAPSULAS DE CAFÉ	230
MAQUINA DE PASTA	246
MAQUINA PARA CROQUETES	127
MARCADOR	148, 185
MARCADOR DE BOLOS	148
MAÇARICOS	128, 129
MAÇO AMACIADOR PARA CARNE	323, 335
MEDIDOR DE LICOR	381
MEDIDOR PARA ESPARGUETTE	247
MOINHO PARA CAFÉ	210
MOINHO RALADOR	294, 313, 344, 345
MOLDE CHOCOLAT	111, 115, 116
MOLDE OVO	96, 126
MOLDE PARA FALAFEL	244
MOLDE PARA GELADOS	121, 122
MOLDE PARA GELO	382, 383
MOLDE PARA SUSHI	245
MOLDE PARA TARTA "PIE"	149
MOLDE RAVIOLI	248
MOLDE TORRÃO	118, 119, 120
MOLDE TRONCO	94

MOLDES PARA PANQUECAS	123
MOLHEIRA	253, 366
MÁQUINA DE FACER MASSAS	135, 136

N

NAPERONS	180, 181
----------	----------

O

OLLA PARA COZER MEJILLONES	34
ÓRACULOS	298
ORGANIZADOR DE GAVETAS	359, 360
ORGANIZADOR DE LATAS	359

P

PAELHEIRAS	71, 72, 73
PALHINHAS	231
PANELA	20, 21, 24, 25, 29, 31, 33, 398, 402
PANELA A PRESSÃO	15, 16
PANELA PARA ESPARGOS	25
PANELA PARA MASSA	31
PANZINHOS	339
PAPEL PARA FORNO	189
PAPEL PARA HAMBÚRGUERES	343
PAPEL PARA VAPOREIRA	245
PASSADOR	209, 267, 268, 404
PASSADORES PARA CHÁ	210
PASSE VITE	269
PEDRA PARA PIZZA	248
PEGAS	20, 43, 74, 316
PENEIRA	173
PENEIRA PARA FARINHA	269
PERFURADOR DE OVOS	298
PESTELLO	268
PICADOR DE ALHOS	302, 306
PICADOR DE GELO	384
PICADOR RAPIDO	305
PICADORA	305, 306
PICO PARA COCKTAILS	381
PINCEL	168, 169, 170, 172, 173, 183, 324
PINÇA PARA FORNO	310
PINÇA PARA PRATOS	310
PINÇA PARA TARROS	310
PINÇAS	170, 307, 308, 309, 310, 334, 337, 367
PINÇAS PARA FONDAN	149, 183
PIPETA PARA MOLHOS	386
PIZZABLECH MIT GITESTRUKTUR	249
PLAAS NIVELADORAS	183
PLACA BAGUETTES	93, 99
PLACA PARA DESCONGELAR	387
PLACA PARA FORNO	78, 87, 94
POLVILHADOR	173
PORTA GUARDANAPOS	367
PORTA UTENSILIOS DE COZINHA	339, 340
PORTA-BOLOS	163
PORTA-TORTILHAS	276
POUSA UTENSILIOS	358, 359
PRATINHO	366
PRATO	338, 391, 393, 396, 397, 398, 401, 402, 414
PRATO DE FERRO FUNDIDO	67
PRATO GIRATÓRIO	162, 163
PRATO MARCADOR	366
PRATO PARA OVOS	407
PRENSA	132, 149
PRENSA DE HAMBÚRGUERES	343
PRENSA-LATAS	388
PROTECTOR DE DEDOS	297
PROTECTOR PARA SERTÃS	66
PULVERIZADOR DE MOLHOS	386

PÃ PARA SERVIR BOLO	172, 324
PÃ RECOLHEDORA DE VERDURAS	298
PÃ À PEIXE	324, 335
PÃ-BASEIE PÃRA PIZZAS	249

Q

QUEBRA-MARISCO	350, 351
QUEBRA-NOZES	304
QUEIJEIRA	262
QUEIMADOR	130

R

RAMEQUIM	103
RASPADOR	311, 312, 313, 324, 326
RASPADOR DE ESCAMAS	303
RASPADOR DE LÍMAO	325
RASPADOR VITROCERÂMICA	364
RECIPIENTE PARA ERVAS	362
RECIPIENTE PARA FRITADEIRE A AR	106
RECIPIENTES PARA MOLHOS	161
REDE PARA CARNE	352
REIPENTE PARA TORTILHAS	246
ROLHAS PARA BOMBA DE VÁCUO	372, 373
ROLHAS PARA VERTER	373, 374, 375, 376, 377
ROLO DE MASSA FONDANT	151
ROLO DE MASSA	172, 336
ROLO DE MASSA CORTADOR GRELHA	150
ROLO DE MASSA TACEJADOR	150
ROLO MIL LISTRAS	182
ROLO PARA CORTAR CROISSANTS	150
ROLO PVC PASTELARIA	132

S

SACA-PONTAS PARA VERDURAS	293
SACA-ROLHAS	369, 370, 371, 372
SACO ISOTÉMICO	410, 411, 412, 413
SACO PARA LEGUMES	352
SACO PARA LEITE VEGETAL	353
SACO PARA PRESUNTO	353
SACO PARA PÃO	251
SACOS DE POLIESTER	352
SACOS PARA ASSAR	386
SACOS PARA GRELHADOR	387
SACOS PASTELEIRO	157, 158, 159, 160
SALEIRO	252, 253
SALEIRO-PIMENTEIRO	254, 261, 262
SECADOR PARA MASSA	247
SEPARADOR GEMA OVOS	354
SERTÃ	39, 40, 41, 42, 45, 46, 47, 49, 50, 51, 52, 54, 55, 56, 57, 58, 59, 60, 63, 64, 65, 398, 403
SERTÃ BLINIS	61
SERTÃ DE CASTANHAS	62
SERTÃ DE CREPES	41, 48, 53, 55, 57, 59, 62
SERTÃ DE PEIXE	59
SERTÃ DUPLA	43, 47, 50, 51, 53, 54, 59, 60
SERTÃ FUNDA	40, 47, 49, 51, 52, 53, 55, 56, 57, 65
SERTÃ PARA TAMAGOYAKI	57
SHAKER PARA COCKTAIL	380
SIFONE SODA	384
SIFÃOS	133, 134
SPATULA CHAPAS	331
SPATULA TAMAGOYAKI	57
SPRAY ANTIADERENTE	190
STAMPO PANETTONE	96, 102
SUPORTE	130
SUPORTE DE ARAME	329, 333
SUPORTE DE FACAS	291
SUPORTE PARA CUPCAKE	163

SUPORTE PARA ESPETADAS	358
SUPORTE PARA OVO	367
SUPORTE PARA PENDURAR PANOS	361
SUPORTE PARA PRESUNTO	337
SUPORTE PARA TACOS	246
SUPORTE PAREDE	340, 404
SUPORTE SACOS PASTELEIRO	158

T

TABULEIRO "EMPANADA"	100
TABULEIRO BOLINHOS	78, 87, 90, 91
TABULEIRO NATAL	77, 92
TABULEIROS	78, 107, 108, 109, 399
TABULERIROS BOLINHOS	82, 85, 86, 125
TACHO	17, 18, 19, 20, 22, 24, 25, 28, 29, 31, 33, 402
TACHO A VAPOR	25
TACHO BAIXO	26, 28, 32, 391, 409
TACHO FORNO	34
TALHERES	275, 282, 283, 415
TAMPA	314, 315, 316, 317
TAMPA DE VIDRO COM BASE	317
TAMPA PARA FLAN	98
TAMPA PARA MICROONDAS	317
TAPA-PRATOS	317
TAPETE DE CONFEITARIA	182
TAPETE ESCORREDOR DE PRATOS	361
TAPETE FORNO	85, 189
TARRO	231, 252, 278, 279, 280
TELA	352
TEMPORIZADOR	368
TENAZES	307
TERMOLATA	222
TERMOMETRO	117, 118, 320, 321, 377
TESOURA	288, 289
THERMO	223, 224, 225, 226
TIGELA	239, 263, 264, 265, 393, 397, 398, 401, 402, 403
TIGELA PARA MOLHOS	266, 408
TIGELA SEMIESFERICA	117, 264
TORRADOR DE PÃO	66
TREMS	26
TÁBUA	318, 319, 320
TÁBUA PARA GNOCCI	247

U

UTENDILIOS PARA COCOLATINHOS	116
UTENSILIO PARA LIMPAR PIMENTO	294
UTENSILIO PARA RETIRAR SEMENTES	304
UTENSILIO PARA TORTILHAS	246

V

VAPOREIRA	245
VELAS DE ANIVERSARIO	164, 165

W

WOK	40, 41, 42, 43, 46, 47, 53, 58, 59, 62
-----	--

Ref.	Pag.	Ref.	Pag.	Ref.	Pag.	Ref.	Pag.	Ref.	Pag.	Ref.	Pag.
000008	417	250310	154	331528	79	403024	51	407024	44	440024	47
000887	417	250312	154	355210	80	403026	51	407028	44	440026	47
000888	417	250416	155	355218	80	403028	51	407210	60	440028	47
000888B	417	250420	155	355222	80	403030	51	407520	44	440030	47
000906	74	250504	155	355308	81	403032	51	407524	44	440128	48
000907	220	250508	155	355422	80	403036	51	407528	44	440225	48
000909	416	250606	154	355426	80	403124	51	409127	43	440228	48
000934	156	250610	154	355430	80	403128	51	409133	43	440420	28
000946	160	250611	154	355527	80	403132	51	409523	44	440424	28
000957	26	250616	154	355728	80	403328	51	409529	44	440428	28
000970	63	250708	154	355732	80	403332	51	410016	56	440520	29
000988	240	250711	154	355824	80	403336	51	410018	56	440524	29
000999	417	250908	155	355826	80	403340	51	410020	56	440614	29
100600	34	250909	155	355828	80	403414	51	410022	56	440616	29
100626	34	251009	155	355925	80	404000	63	410024	56	440724	47
100628	34	252000	156	355930	80	404014A	63	410026	56	440728	47
100630	34	252001	156	355935	80	404014B	63	410028	56	440828	47
100632	34	252100	156	356016	81	404014C	63	410030	56	440832	47
102308	414	252200	157	356018	81	404014D	63	410226	72	441020	47
140626	101	252300	155	356020	81	404014E	63	410230	72	441024	47
140628	101	252400	156	356124	81	404014F	63	410234	72	441124	47
140807	101	260016	415	356128	81	404230	42	410238	72	441130	47
140808	101	260020	415	356132	81	404512	61	410242	72	441226	48
140809	101	260024	415	356224	81	404514	61	410326	56	450016	54
142000	101	260100	416	356228	81	405014	58	410420	57	450018	54
151215	348	260101	416	356232	81	405014C	58	410424	57	450020	54
151220	348	260102	416	356524	81	405016	58	410428	57	450022	54
200730	189	260103	416	356526	81	405018	58	410432	57	450024	54
200742	189	260300	416	356528	81	405020	58	410524	56	450026	54
200840	190	260402	415	356626	81	405022	58	410528	56	450028	54
215000	102	260403	415	356928	81	405024	58	410532	56	450030	54
215001	103	260405	415	356932	81	405026	58	410536	56	450100	55
215002	103	260410	415	380030	73	405028	58	410540	56	450226	55
215003	103	300214	32	380034	73	405030	58	410618	57	450400	62
215004	103	300216	32	380038	73	405100	59	410624	57	450401	62
215005	102	300620	60	380042	73	405218	58	410626	57	450402	62
215006	102	300624	60	380046	73	405226	58	410700	57	450403	62
230010	103	300929	108	380050	73	405314	32	410816	31	450404	62
250000	153	300935	108	400016N	52	405316	32	410820	31	450405	62
250001	153	300940	108	400018N	52	405318	32	410824	31	450406	62
250002	153	301140	108	400020N	52	405320	32	410828	31	450407	62
250003	153	321118	60	400022N	52	405324	32	410916	31	450530	62
250004	153	321120	60	400024N	52	405726	59	410920	31	450726	62
250006	153	321122	60	400026N	52	405820	59	410924	31	450820	55
250007	153	321124	60	400028N	52	405823	59	411012	31	450824	55
250008	153	321126	60	400030N	52	405826	59	411014	31	450826	55
250010	153	321128	60	400124N	53	405828	59	411016	31	450828	55
250012	153	321130	60	400128N	53	405914	59	411018	31	450924	55
25001A	153	330029	107	400204	48	405920	59	411020	31	450928	55
250104	154	330040	107	400206	48	405924	59	411218	57	450932	55
250106	154	330140	107	400207	48	405926	59	411326	57	450936	55
250108	154	330408	79	400318N	53	405928	59	411328	57	451026	55
250109	154	330926	79	400328N	53	406023	44	411414	31	451126	72
250111	154	331025	79	400428N	53	406029	44	411416	31	451130	72
250208	154	331030	79	400528N	53	406035	59	411522	31	451134	72
250210	154	331118	79	400626N	53	406116	58	440014	47	451138	72
250212	154	331228	79	401534	107	406130	59	440016	47	451142	72
250303	154	331232	79	403018	51	406412	32	440018	47	451222	55
250304	154	331524	79	403020	51	406604	59	440020	47	451226	55
250306	154	331526	79	403022	51	407020	44	440022	47	451320	54

Ref.	Pag.	Ref.	Pag.	Ref.	Pag.	Ref.	Pag.	Ref.	Pag.	Ref.	Pag.
451324	54	480135	105	500422	52	600230	40	607526	22	612206	198
461010	20	480140	105	500424	52	600324	40	607528	22	612209	198
461011	20	480226	105	500426	52	600328	40	607532	22	612212	198
461024	19	480319	105	500428	52	600425	41	607614	22	612303	198
461028	19	480321	105	500430	52	600628	41	607616	22	612306	198
461030	19	480324	105	500432	52	601514N	42	607618	22	612309	198
461032	19	480420	105	500436	52	605016	24	607620	22	612312	198
461036	19	480528	105	500520	52	605018	24	607718	21	620003	203
461040	19	480625	105	500524	52	605020	24	607720	21	620007	203
461120	19	480700	105	500528	52	605022	24	607722	21	620010	203
461124	19	480723	104	500532	52	605024	24	607724	21	620012	203
461128	19	480730	104	500624	52	605026	24	607726	21	620018	203
461216	20	480734	104	500628	52	605028	24	607728	21	620107	205
461318	42	480740	104	500632	52	605032	24	607732	21	620212	205
461320	42	480840	104	501028	73	605112	24	610109	199	620302	193
461322	42	481105	174	501032	73	605114	24	610115	199	620304	193
461324	42	481110	174	501036	73	605116	24	610120	199	620306	193
461326	42	481208	174	501040	73	605118	24	610201	199	620310	193
461328	42	481210	174	501046	73	605216	24	610202	199	620350	193
461330	42	481305	174	505016	50	605218	24	610203	199	620351	193
461436	71	481310	174	505018	50	605220	24	610204	199	620352	193
462024	18	482518	50	505020	50	605222	24	610415	200	620353	193
462028	18	482520	50	505022	50	605224	24	610425	200	620407	204
462032	18	482522	50	505024	50	605226	24	610425B	200	620508	206
462036	18	482524	50	505026	50	605228	24	610425M	200	620712	206
462040	18	482526	50	505028	50	605232	24	610425N	200	620801	208
462120	18	482528	50	505030	50	605318	24	610901	198	620804	208
462124	18	482530	50	505126	50	605320	24	610903	198	620806	208
462128	18	490000	43	505220	50	605322	24	610906	198	620904	205
464024	17	490126	43	505224	50	605324	24	610909	198	621000	207
464028	17	490230	43	507518	39	605326	24	610912	198	621005	207
464032	17	495016	49	507520	39	605328	24	610914	198	621015	207
464036	17	495018	49	507522	39	605332	24	610958	198	621030	207
464120	17	495020	49	507524	39	605418	24	610959	198	621040	207
464124	17	495022	49	507526	39	605420	24	610960	198	621408	204
464128	17	495024	49	507528	39	605422	24	610961	198	621510	204
464218	39	495026	49	507530	39	605424	24	611002	194	621612	204
464220	39	495028	49	590000	265	605426	24	611004	194	621704	200
464222	39	495030	49	590100	266	605428	24	611006	194	621708	200
464224	39	495114	29	590101	266	605432	24	611010	194	621908	200
464226	39	495116	29	590102	266	606016	20	611015	194	621912	200
464228	39	495228	49	590200	265	606020	20	611302	193	622106	197
465018	41	495324	49	590201	265	606022	20	611304	193	622109	197
465020	41	495328	49	590300	265	606024	20	611306	193	622112	197
465022	41	495420	29	590400	265	606028	20	611312	193	622603	205
465024	41	495424	29	590500	266	606112	20	611358	193	622805	205
465026	41	495428	29	590501	266	606114	20	611359	193	623106	197
465028	41	495520	29	590502	266	606116	20	611360	193	623109	197
465030	41	495524	29	590600	265	606216	20	611361	193	623112	197
465032	41	495628	49	590601	265	606220	20	611700	209	623202	197
465128	41	495632	49	590700	265	606222	20	611950	201	623203	197
465222	41	497518	56	590701	265	606224	20	611951	201	623206	197
465226	41	497520	56	590800	266	606228	20	611952	201	623209	197
465330	41	497522	56	600018	40	606320	20	612050	201	623212	197
480024	105	497524	56	600020	40	606324	20	612051	201	623703	199
480027	105	497526	56	600022	40	606328	20	612052	201	623706	199
480030	105	497528	56	600024	40	607518	22	612103	201	623710	199
480123	105	497530	56	600026	40	607520	22	612104	201	623803	228
480126	105	500418	52	600028	40	607522	22	612201	198	624003	206
480130	105	500420	52	600030	40	607524	22	612203	198	624103	206

Ref.	Pag.	Ref.	Pag.	Ref.	Pag.	Ref.	Pag.	Ref.	Pag.	Ref.	Pag.
624204	206	627806	197	630203	196	653228	46	667000	300	682103	99
624303	206	627809	197	630206	196	662016	25	667100	327	682200	149
624400	208	627812	197	630209	196	662018	25	667101	327	682210	149
624500	228	627903	195	630212	196	662020	25	667102	327	682250	142
624903	201	627906	195	650130	99	662022	25	667103	327	682300	354
624906	201	627909	195	650218	98	662024	25	667104	327	682400	363
624910	201	627912	195	650223	98	662026	25	667200	229	682500	304
624912	201	628002	258	650226	98	662028	25	667330	316	682600	295
625300	208	628005	258	651000	98	662032	25	667403	414	682700	249
625406	199	628007	258	651005	99	662112	25	667536C	220	682800	330
625408	199	628100	287	651006	99	662114	25	667536T	220	682900	245
625410	199	628203	231	651007	99	662116	25	667626C	220	683000	248
625506	201	628206	231	651008	99	662216	25	667626Z	220	683050	248
625510	201	628318	348	651009	99	662220	25	667734	68	683100	335
625603	205	628406	198	651425	108	662222	25	667738	68	683210	365
625706	205	628409	198	651430	108	662224	25	680000	303	683214	365
625808	206	628412	198	651435	108	662228	25	680125	172	683217	365
625926	67	628500	358	651440	108	662524	25	680130	172	683300	381
625930	67	628600	358	651616	98	663024	25	680135	172	683414	345
626011	347	628727	244	651618	98	664016	25	680140	172	683416	345
626015	347	628800	351	651620	98	665210	26	680200	282	683418	345
626103S	212	628904	15	651830	108	665212	26	680201	282	683500	339
626105B	212	628906	15	651835	108	665214	26	680202	282	683600	247
626107S	212	628910	15	651840	108	665216	26	680203	283	683700	139
626206L	220	629002	16	651845	108	665218	26	680204	282	683900	247
626305S	220	629003	16	651850	108	665220	26	680205	282	684035	259
626405	411	629028	244	651860	108	665310	26	680206	282	684050	259
626410	411	629032	244	652028	72	665312	26	680207	282	684100	247
626415	411	629128	244	652032	72	665314	26	680208	283	684110	247
626420	411	629203	196	652034	72	665316	26	680209	283	684120	247
626430	411	629206	196	652036	72	665318	26	680210	282	684200	337
626500	412	629209	196	652040	72	665614	26	680250	283	684300	129
626501	413	629212	196	652130	71	665616	26	680300	104	684400	310
626505	412	629303	196	652134	71	665618	26	680301	104	684500	345
626510	412	629306	196	652138	71	665628	357	680302	104	684600	148
626515	412	629309	196	652142	71	665730	163	680303	104	684700	360
626520	412	629312	196	652228	71	665814	28	680304	104	684900	350
626530	412	629403	196	652232	71	665816	28	680305	104	685015	228
626608	204	629406	196	652234	71	665818	28	680400	363	685022	228
626712	204	629409	196	652236	71	665820	28	680500	363	685100	228
626811	204	629412	196	652240	71	665824	28	680600	303	685206	273
626912	206	629511	207	652640	100	666010	27	680700	286	685210	273
627026	67	629612	207	652645	100	666012	27	680700C	287	685215	273
627030	67	629702	194	652735	108	666014	27	680750C	286	685300	361
627100	74	629704	194	652738	108	666016	27	680800	249	685350	358
627221	412	629706	194	652818	45	666018	27	680900	312	685400	334
627227	413	629710	194	652820	45	666020	27	681008	278	685500	382
627308	207	629802	194	652822	45	666118	27	681011	278	685602	172
627407	205	629804	194	652824	45	666214	27	681015	278	685605	172
627511	204	629806	194	652826	45	666310	28	681100	351	685607	172
627605	410	629810	194	652828	45	666312	28	681200	361	685700	297
627610	410	629902	194	652918	46	666314	28	681300	312	685800	229
627615	410	629904	194	652920	46	666316	28	681405	161	685900	103
627620	410	629906	194	652922	46	666424	28	681410	161	685910	103
627630	410	629910	194	652924	46	666520	28	681500	250	686000	149
627705	411	630000	194	652926	46	666600	313	681601	175	686010	149
627710	411	630103	196	652928	46	666700	385	681700	148	686100	150
627715	411	630106	196	653024	46	666800	251	681800	144	686110	150
627720	411	630109	196	653028	46	666909	343	681900	306	686200	303
627730	411	630112	196	653130	46	666911	343	682000	312	686300	296

Ref.	Pag.	Ref.	Pag.	Ref.	Pag.	Ref.	Pag.	Ref.	Pag.	Ref.	Pag.
686400	306	688901	202	692100	235	700107	257	703714	35	705810	210
686500	119	688902	202	692101	235	700112	257	703719	35	705920	251
686600	276	689000	345	692102	235	700201	256	703724	35	705925	251
686700	277	689100	163	692103	235	700202	256	703728	35	706020	251
686710	277	689110	163	692200	236	700203	256	703807	267	706025	251
686720	277	689200	272	692201	236	700204	256	703810	267	706250	127
686730	277	689210	272	692202	236	700308	414	703812	267	706300	366
686740	277	689300	337	692203	236	700309	414	703815	267	706400	165
686750	277	689400	337	695000	369	700311	414	703818	267	706550	353
686800	335	689500	337	695001	369	700512	340	703820	267	706600	178
686900	335	689600	338	695002	373	700600	275	703834	267	706850	390
687000	390	689700	338	695003	369	700700	379	703907	267	706900	308
687110	259	689800	338	695004	369	700825	263	703910	267	707150	243
687215E	167	689900	338	695005	370	700830	263	703915	267	707700	127
687215M	168	690018	360	695006	371	700835	263	704007	267	707900	302
687300	223	690108	359	695007	370	700840	263	704008	267	708200	364
687400	135	690115	359	695008	370	700900	67	704009	267	708250	364
687507	363	690122	359	695009	372	700950	67	704010	267	708450	164
687600	246	690124	359	695010	372	701117	260	704012	267	708534	308
687610	246	690132	359	695011	373	701218	260	704014	267	708544	308
687730	105	690138	359	695012	373	701400	175	704016	267	708700	339
687735	105	690233	360	695014	375	701500	140	704018	267	708706	339
687800	298	690319	225	695015	371	701600	177	704020	267	708710	339
687900	240	690400	277	695016	371	701712	180	704129	317	708800	388
687901	240	690410	277	695017	371	701726	180	704216	173	708933	148
687902	240	690420	277	695018	372	701734	180	704220	173	709100	372
687903	240	690430	277	695019	372	701830	180	704225	173	709200	145
687904	240	690440	277	695020	374	701910	175	704329	316	709209	145
687905	240	690524	310	695021	374	702026	170	704400	128	709320	269
687906	240	690530	310	695022	374	702032	170	704450	129	709400	337
687907	240	690600	313	695023	374	702036	170	704500	129	709422	337
687908	240	690714	209	695024	375	702110	231	704700	130	709500	354
687909	240	690811	343	695025	375	702225	170	704800	130	709703	257
687910	240	690917	245	695026	373	702236	170	704903	288	709705	257
687911	240	690923	245	695027	375	702241	170	704904	288	709710	257
688000	240	691000	359	695028	373	702310	352	704904C	289	710112	263
688001	240	691100	318	695029	374	702400	146	704905	288	710116	263
688002	240	691216	338	695030	377	702500	146	704906	289	710119	263
688003	240	691218	338	695031	376	702650	343	704909	288	710124	263
688004	240	691220	338	695032	372	702700	146	704910	289	710129	263
688005	240	691222	338	695033	372	702800	210	704911	288	710300	328
688006	240	691224	338	695034	377	702900	210	704912	289	710400	328
688007	240	691226	338	695035	377	703007	267	704913	289	710401	328
688008	240	691228	338	695036	374	703008	267	705005	257	710500	328
688009	240	691300	362	695037	384	703010	267	705105	257	710600	328
688010	240	691400	300	695038	384	703012	267	705205	257	710700	328
688011	240	691500	230	695039	372	703014	267	705210	289	710800	328
688100	306	691600	390	695040	370	703015	267	705300	311	710900	328
688200	290	691700	237	695041	373	703016	267	705312	198	711020	268
688300	231	691701	238	695042	378	703018	267	705312	35	711114	268
688400	367	691800	239	695043	370	703020	267	705320	35	711124	268
688516	106	691801	239	695044	371	703022	267	705324	35	711224	414
688520	106	691802	239	695045	370	703025	267	705328	35	711320	379
688608	231	691900	239	695046	378	703105	226	705510	36	711414	379
688612	231	691901	239	699900	270	703200	210	705520	36	711503	414
688702	259	691902	239	699910	270	703206	210	705530	36	711620	348
688705	259	692000	239	700001	256	703500	146	705610	303	711700	366
688800	353	692001	239	700002	256	703625	316	705706	244	711807	379
688900	202	692002	239	700105	257	703630	316	705710	244	711809	379

Ref.	Pag.	Ref.	Pag.	Ref.	Pag.	Ref.	Pag.	Ref.	Pag.	Ref.	Pag.
711810	379	715311	254	717030	264	723402	139	728502	173	732800	148
711812	379	715313	254	717130	163	723500	147	728600	301	732900	143
711816	379	715314	254	717216	100	723650	388	728750	361	733000	143
711820	379	715315	254	717300	100	723700	147	728914G	275	733100	143
711826	379	715429	318	717310	100	723800	147	728914P	275	733400	250
712000	276	715433	318	717700	362	723900	146	728922G	275	733600	387
712100	125	715437	318	717800	362	724000	145	728923	180	733700	380
712150	125	715518	317	718007	132	724100	145	728927	180	733750	380
712200	360	715520	317	718210	290	724200	297	728932	180	733804	330
712800	329	715526	317	718300	269	724450	387	729011	180	733806	330
712900	329	715530	317	718508	131	724500	367	729021	180	733900	329
713000	329	715630	249	718510	131	724600	367	729026	180	733901	330
713100	329	715719	314	718710	131	724700	367	729029	180	733902	330
713200	329	715723	314	719106	331	724912	297	729204	179	733903	329
713302	260	715727	314	719110	331	724917	297	729307	178	734050	331
713405	226	715731	314	719600	297	725012	297	729308	178	734051	331
713410	226	715737	314	719800	126	725017	297	729400	268	734052	331
713610	226	715826	314	720006	213	725033	148	729500	181	734053	331
713705	227	715830	314	720106	213	725100	367	729501	181	734054	331
713710	227	715932	366	720200	415	725200	249	729502	181	734200	136
713810	227	716004	130	720305	213	725300	301	729510	181	734300	267
713830	249	716005	130	720307	213	725404	246	729511	181	734310	267
713900	317	716006	130	720407	213	725610	243	729520	181	734314	267
713914	317	716007	130	720500	414	725712	131	729521	181	734600	164
714000	340	716008	130	720607	213	725910N	30	729600	146	734700	143
714100	340	716009	130	720610	213	725910R	30	729900	297	734810	164
714219	314	716010	130	720614	415	725913R	30	730000	99	734900	143
714223	314	716012	130	720616	415	725921R	30	730100	313	735000	161
714227	314	716020	130	720618	415	725924R	30	730210	299	735300	169
714231	314	716024	130	720620	415	726015N	30	730420	117	735500	160
714237	314	716050	130	720700	360	726015R	30	730514	263	735700	147
714243	314	716090	132	720920	211	726027R	30	730518	263	735800	363
714319	314	716106	131	721010	292	726200	285	730520	263	735900	176
714323	314	716107	131	721010R	292	726210	285	730522	263	735901	176
714327	314	716108	131	721011R	292	726300	304	730526	263	735903	176
714331	314	716109	131	721110	293	726500	100	730530	263	735904	176
714337	314	716110	131	721221	35	726618	263	730610	241	735905	177
714343	314	716112	131	721600	360	726624	263	730710	351	735907	176
714400	256	716250	275	721700	304	726800	302	730818	66	735908	176
714401	256	716300	308	721707	99	727020	130	730824	66	735909	176
714522	414	716410	309	721708	99	727060	129	730826	66	735911	177
714620	268	716513	336	721820	348	727220	269	730828	66	735912	177
714624	268	716518	336	721917	263	727300	380	730907	363	735913	177
714720	268	716730	337	722013	366	727350	380	730909	363	735914	177
714800	252	716732	337	722224	298	727500	245	730911	363	736000	179
714805	252	716740	337	722310	131	727526	245	731200	152	736001	179
714810	252	716816	268	722400	361	727608	286	731210	152	736002	179
714810G	252	716818	268	722500	373	727608P	286	731300	303	736003	179
714810N	252	716820	268	722600	346	727612	286	731400	386	736100	163
714850	253	716906	131	722708	131	727612P	286	731500	209	736101	163
714855	253	716908	131	722712	131	727615	286	731600	365	736200	221
714860	253	716910	131	722808	145	727650	286	731702	257	736300	170
714900	253	717008	264	722900	366	727708	132	731705	257	736600	147
714950	252	717012	264	723008	100	727908	131	731707	257	736700	308
715003	252	717014	264	723100	293	727910	131	731710	257	736800	175
715005	252	717016	264	723150	293	728000	361	732300	309	736900	175
715010	252	717018	264	723200	309	728100	268	732400	169	737000	178
715110	252	717020	264	723300	365	728200	387	732500	169	737200	177
715210	253	717022	264	723400	139	728310	287	732600	169	737401	178
715310	253	717025	264	723401	139	728320	287	732700	148	737450	179

Ref.	Pag.	Ref.	Pag.	Ref.	Pag.	Ref.	Pag.	Ref.	Pag.	Ref.	Pag.
737504	182	740438	291	743560	256	747340	318	749600	303	753202	258
737600	178	740455	291	743600	349	747422	334	749727	316	753205	258
737700	178	740500	333	743700	359	747425	334	749800	295	753385	275
737810	166	740700	111	743825	348	747430	334	749924	365	753401A	274
737810E	167	740800	309	743850	348	747515	334	749928	365	753401G	274
737815	166	740821	309	743875	348	747522	334	750000	306	753406G	274
737815E	167	740830	309	743900	262	747522R	336	750100	349	753406P	274
737820	166	740900	365	744010	384	747530	334	750225	171	753408G	274
737820E	167	740921	365	744100	384	747530R	336	750230	171	753408P	274
737825	166	741016	310	744200	296	747625	334	750235	171	753450	274
737825E	167	741021	310	744300	309	747625R	336	750240	171	753455	274
737830	166	741100	260	744500	161	747630	334	750350	305	753500R	301
737830E	167	741202	226	744600	347	747630R	336	750415	171	753620	339
737910	166	741203	226	744610	347	747635R	336	750515	171	753630	339
737910E	167	741316	117	744700	161	747640R	336	750600	312	753700	386
737915	166	741407	224	744800	381	747730	335	750710	210	753801	224
737915E	167	741410	224	744900	297	747734	335	750720	210	753802	224
737920	166	741412	224	745000	309	747830	335	750805	133	753802C	223
737920E	167	741508	209	745100	308	747830R	336	750900	111	753803	224
737925	166	741600	296	745200	380	747918	334	750902	134	753805	224
737925E	167	741700	293	745325	307	747920	336	750905	134	753805C	224
737930	166	741824	308	745330	307	747930	336	750910	134	753807	224
737930E	167	741830	308	745335	307	747940	379	751000	134	753810	224
738000	166	741900	310	745439	307	747950	151	751050	134	753812	224
738000E	167	742000	209	745500	294	747951	151	751123	308	753821	224
738100	166	742200	173	745605	257	747952	151	751215	258	753903	225
738100E	167	742300	334	745610	257	747953	151	751230	258	753904	225
738200	178	742420	269	745700	293	748000	343	751250	258	753906	224
738300	166	742424	269	745803	225	748001	343	751325	258	753908	224
738300E	167	742500	137	745805	225	748002	343	751350	258	753910	224
738400	166	742501	137	745807	225	748110	225	751430	335	754000	122
738400E	167	742600	169	745810	225	748115	225	751530	335	754110	272
738450	166	742601	169	745903A	213	748200	291	751610	299	754120	272
738450E	167	742700	168	745903V	213	748300	364	751703	212	754303	259
738500	166	742800	303	745905A	213	748400	313	751705	212	754305	259
738500E	168	742905	280	745905V	213	748401	313	751800	170	754410	250
738600	182	742908	280	746004R	213	748410	312	751823	66	754420	250
738700	331	742915	280	746004V	213	748450	313	751900	366	754500	182
738750	331	743028	318	746005V	213	748451	313	751910	366	754510	276
738760	330	743033	318	746100	295	748500	229	751918	66	754701	271
738770	57	743040	318	746200	111	748601	339	752050	346	754704	271
738800	304	743100	385	746300	190	748602	339	752060	346	754709	271
738900	128	743221	36	746400	352	748700R	152	752109	339	754709A	271
739000	250	743300	349	746450	352	748700V	152	752118	339	754710	271
739001	302	743400	320	746500	102	748800	171	752209	339	754716	271
739002	349	743401	320	746505	102	748900	309	752302	258	754750	272
739100	293	743402	320	746509	102	749000	302	752305	258	754804	271
739300	354	743403	320	746630	335	749050	302	752400	179	754807	271
739500	182	743404	321	746650	352	749100	276	752550	170	754810	271
739614	346	743405	321	746700	242	749110	276	752600	384	754810A	271
739801	378	743406	321	746800	294	749200	161	752734	158	754833	272
739850	311	743407	368	746902	258	749400	320	752740	158	755000	358
739901	279	743408	368	746905	258	749430	319	752745	158	755000P	358
740000	279	743409	321	747000	242	749433	319	752750	158	755001	258
740101	227	743410	321	747001	242	749433A	319	752755	158	755002	258
740111	227	743411	368	747100	381	749433R	319	752760	158	755005	258
740202	227	743500	255	747210	280	749433V	319	752850	132	755010	258
740205	227	743510	255	747220	280	749433Y	319	752900	183	755050	357
740310	227	743550	256	747230	280	749438	319	753100	119	755050P	357

Ref.	Pag.	Ref.	Pag.	Ref.	Pag.	Ref.	Pag.	Ref.	Pag.	Ref.	Pag.
755100	261	758410	217	759701	329	762043	325	768600	261	773820	245
755101	271	758435	217	759801	376	762044	325	768700	261	773901	161
755104	271	758435A	218	759803	376	762045	325	768710	261	773902	161
755106	271	758435B	217	759811	376	762046	326	768715	261	773904	161
755108	271	758435C	218	759812	376	762047	323	768800	262	773907	161
755108A	271	758435D	218	759813	376	762048	323	768910	305	774016	117
755150	272	758435E	218	759900	376	762049	324	769000	359	774100	296
755200	261	758435F	217	760030	157	762050	326	769100	380	774200	247
755300	262	758435G	218	760030E	157	762051	323	769200	364	774300	125
755305	262	758435H	218	760040E	157	762052	323	769500	136	774350	125
755400	262	758435I	217	760045	157	762053	326	769745	355	774356	125
755405	262	758435K	218	760055	157	762910	215	769800	298	774503	136
755500	262	758435N	218	760055E	157	762920	215	769911	261	774504	145
755505	262	758435O	218	760245	158	762930	215	770100	355	774505	145
755600	269	758435P	217	760400B	156	762940	215	770200	355	774516	345
755726	230	758435R	217	760603	157	762950	215	770250	355	774521	345
755748	230	758435U	218	760604	157	763150	310	770400	356	774531	345
755833	336	758435V	217	760700	159	763300	350	770401	356	774610	126
755918	335	758435Z	218	760900	209	763450	299	770402	356	774700	350
756000	171	758450	217	761000	173	763600	307	770403	356	774710	292
756200	165	758450A	219	761003	173	763740	123	770404	357	774950	216
756300	159	758450B	217	761100	149	763760	123	770500	149	774951	216
756450	140	758450C	219	761200	308	763800	346	771100	126	774952	216
756500	124	758450D	219	761400	309	763900	171	771200	351	774953	216
756600	311	758450E	219	761500	172	764000	376	771400	158	774954	215
756650	312	758450F	219	761600	210	764001	376	771700	150	774955	215
756700	172	758450G	219	761900	249	764002	376	771800	150	774956	215
756830	159	758450H	219	762010	322	764006	375	771900	160	774957	215
756835	159	758450I	219	762011	322	764010	376	772100	389	774958	215
756840	159	758450J	219	762012	322	764011	376	772250	389	774959	214
756845	159	758450K	219	762013	324	764012	376	772260	389	774960	215
756850	159	758450L	219	762014	324	764022	375	772300	305	774961	215
756860	159	758450M	219	762015	324	764140	123	772400	299	774962	215
756950	123	758450N	219	762016	324	764145	123	772500	312	774963	215
757004	272	758450O	219	762017	324	764150	123	772600	311	774964	215
757006	272	758450P	217	762018	324	764155	123	772700	332	774965	215
757010	272	758450Q	219	762019	324	764160	123	772800	332	774966	215
757015	272	758450R	217	762020	325	764200	178	772900	332	774967	215
757100	173	758450S	219	762021	325	764410	330	773000	332	774968	215
757203	272	758450T	219	762022	325	764412	330	773050	332	775035	223
757205	272	758450U	219	762023	326	764540	340	773100	246	776210	112
757208	272	758450V	217	762024	325	764550	340	773216	345	776310	112
757212	272	758450W	219	762025	322	764650	367	773221	345	776400	306
757300	333	758450Y	219	762026	324	764700	230	773231	345	776500	126
757400	173	758450Z	219	762027	324	764838	251	773316	344	776600	243
757505P	212	758475	217	762028	323	764870	251	773321	344	776700	117
757600	333	758475C	216	762029	323	765100	136	773331	344	776800	144
757700	333	758510	36	762030	324	765200	174	773416	344	776900	367
757800	333	758606	223	762031	323	765320	269	773421	344	777000	127
758000	172	758609	223	762032	325	765324	269	773431	344	777000E	127
758104B	212	758704	225	762033	326	765410	250	773510	126	777150	305
758105B	212	758706	225	762034	323	765500	366	773512	126	777200	344
758205G	212	758814	226	762035	325	765618	223	773515	126	777201	344
758207G	212	758818	226	762036	325	765700	342	773602	132	777300	296
758328	221	758910G	212	762037	324	765810	390	773606	132	777400	388
758328B	221	758910P	212	762038	325	765950	383	773608	132	777500	386
758341	221	759000	332	762039	325	768200	288	773740	158	777510	386
758341B	221	759100	332	762040	326	768300	160	773755	158	777609	353
758403	216	759200	332	762041	326	768414	353	773800	245	777702	352
758405	216	759300	332	762042	326	768500	261	773810	245	777800	294

Ref.	Pag.	Ref.	Pag.	Ref.	Pag.	Ref.	Pag.	Ref.	Pag.	Ref.	Pag.
777910	386	783760	290	787045	187	790423	273	795650	258	798900	141
778000	172	783770	291	787125	187	790432	273	795700	122	799000	291
778110	231	783950	121	787130	187	790500	298	795800	122	799100	119
778200	229	784000	295	787135	187	790600	100	795900	243	799210	168
778333	248	784100	295	787140	187	790800	164	796000	351	799220	168
778400	378	784150	295	787145	187	790900	118	796127	242	799230	168
778450	378	784200	138	787225	187	790910	117	796200	290	799240	168
778600	344	784201	138	787230	187	790920	117	796300	112	799300	114
778900	387	784202	138	787300	183	791125	307	796400	294	799302	114
779000	352	784203	138	787310	183	791130	307	796500	149	799304	114
779010	352	784204	138	787410	174	791135	307	796600	298	799305	114
779100	311	784206	138	787500	127	791200	183	796711	364	799400	113
779101	311	784208	138	787600	126	791400	302	796721	364	799401	113
779200	298	784338	248	787701	150	791600	381	796900	222	799402	113
779400	248	784340	248	787800	101	791700	381	796905	222	799403	113
779401	248	784400	149	787900	297	791800	112	796933A	222	799404	113
779510	353	784700	371	788000	116	792050	182	796933D	222	799510	305
779750	298	784900	377	788100	116	792100	140	796933P	222	799600	306
780010	211	785100	374	788300	182	792300	135	796933R	222	799700	301
780020	211	785250	385	788402	186	792400	384	796933V	222	799820	246
780030	211	785300	374	788403	186	792600	110	796950	222	799904	221
780100	211	785400	377	788405	186	792650	110	796950A	222	799904A	221
780110	211	785500	385	788406	186	792900	124	796950D	222	799904R	221
780310	346	785600	385	788407	186	793000	144	796950P	222	800122	101
780410	346	785700	385	788408	186	793050	143	796950R	222	800124	101
780730	162	785800	350	788409	187	793100	160	796950V	222	800126	101
780825	162	786000	378	788411	187	793300	296	797000	304	801000	146
780900	379	786050	377	788500	342	793400	129	797105	278	802000	99
781000	381	786075	378	788605	279	793500	120	797109	278	802200	100
781100	373	786100	379	788619	279	793501	120	797112	278	802300	99
781200	162	786201	164	788710	279	793502	120	797119	278	802428	102
781400	350	786203	164	788720	279	793503	120	797200	340	810400	66
781500	350	786206	165	788902	144	793600	380	797210	340	810525	101
781700	249	786209	165	788903	144	793700	141	797220	340	810530	101
781810	127	786214	165	789000	140	793800	141	797250	340	812500	280
781900	347	786215	165	789006	140	793900	301	797300	284	812503	280
782000	300	786300N	165	789007	139	794000	302	797301	284	812504	280
782110	229	786301N	165	789009	142	794117	246	797302	284	812505	280
782310	342	786302N	165	789010	140	794122	246	797303	284	812506	280
782410	342	786303N	165	789100	185	794200	137	797304	285	812507	281
782500E	278	786304N	165	789200	183	794201	137	797305	285	812508	281
782501E	278	786305N	165	789250	183	794202	137	797306	285	812509	281
782502E	278	786306N	165	789300	162	794302	147	797310	285	812518	281
782505	278	786307N	165	789301	162	794303	147	797311	285	812519	281
782650	66	786308N	165	789310	162	794304	147	797312	285	812520	281
782750	287	786309N	165	789440	158	794400	141	797500	286	812522	280
782800	160	786510	124	789600	185	794550	139	797600	230	812523	280
782912	296	786511	124	789750	111	794600	140	797710	362	815030	188
783016	342	786515	124	789800	300	794700	142	797810	209	815110	188
783024	342	786600	129	790100	159	794800	141	797812	209	815115	188
783120	341	786725	171	790300	259	794900	141	797814	209	815120	188
783124	341	786730	171	790400	344	795000	142	798100	150	815125	188
783300	364	786800	170	790402	273	795001	142	798400	413	815130	188
783400	122	786922	242	790406	273	795100	381	798410	413	815135	188
783450	122	787020	187	790408	273	795250	377	798500	317	815212	188
783620	341	787025	187	790410	273	795400	122	798640	158	815215	188
783626	341	787030	187	790412	273	795500	351	798700	172	815220	188
783700	290	787035	187	790415	273	795612	258	798714	172	815225	188
783750	291	787040	187	790420	273	795625	258	798800	111	815230	188

Ref.	Pag.	Ref.	Pag.	Ref.	Pag.	Ref.	Pag.	Ref.	Pag.	Ref.	Pag.
815320	188	823926	95	840230	77	871900	125	903935	401	908126	397
815425	188	824121	93	840324	78	872000	124	903940	401	908128	397
815520	189	824228	94	840500	78	872201	184	904012	402	908224	400
815634	189	824328	90	840634	78	872202	185	904114	402	908312	397
815715	188	824426	95	840728	78	872203	185	904116	402	908314	397
815720	188	824511	98	840826	78	872204	184	904118	402	908316	397
815725	188	824600	96	840935	78	872206	185	904122	403	908320	397
815730	188	824608	96	841041	78	872207	184	904212	401	908405	398
820110	98	824700	96	850000	111	872208	184	904214	401	908501	400
820112	98	824701	96	850100	123	872209	184	904216	401	908612	398
820114	89	824703	96	850200	112	872210	185	904220	401	908725	397
820116	89	824802	93	850300	115	872400	179	904301	404	908730	397
820118	89	824803	93	850310	115	873000	264	904302	404	908736	397
820120	89	824804	93	850320	116	873200	241	904410	402	908805	400
820122	89	824910	92	860021	85	875001	82	904500	404	908906	399
820124	89	825016	94	860301	115	875125	82	904609	406	908909	399
820126	89	825020	94	860303	115	875130	82	904707	402	909010	399
820128	89	825603	95	860305	115	875228	82	904708	402	909114	398
820130	89	825924	88	860307	115	875322	82	904808	406	909210	398
820224	95	826022	88	860311	115	875424	82	905015	403	909308	409
820226	95	826420	90	860312	115	875520	82	905017	403	909311	398
820228	95	826426	90	860314	114	875526	82	905020	403	909314	398
820314	97	826517	89	860315	116	875600	82	905022	403	909407	397
820320	90	826524	89	860400	118	875700	83	905027	403	909408	397
820325	90	826628	89	860500	116	875712	83	905116	403	909512	398
820330	90	826712	96	860609	382	875719	83	905120	403	909612	398
820335	90	826716	96	860621	382	875800	83	905124	403	909814	398
820410	97	826900	91	865000	189	875900	83	905232	403	909818	398
820412	97	827000	91	865005	189	876000	83	905300	404	909932	399
820501	90	827130	89	865050	189	876050	83	905437	403	910103	396
820502	95	827250	94	870001	85	889000	77	905608	401	910132	400
820510	91	827300	92	870004	84	889010	77	905612	401	910145	396
820622	94	827400	92	870005	84	901008	405	905614	401	910210	396
820724	95	827600	163	870006	85	901118	401	905713	405	910222	399
820920	90	827700	91	870007	85	901120	401	905800	404	910250	396
820926	90	827800	90	870008	84	901122	401	905926	399	910350	396
821024	89	827920	92	870009	85	901124	401	906214	403	910370	396
821600	96	827921	92	870010	85	901126	401	906316	405	910410	396
821700	96	827926	92	870012	85	901128	401	906320	405	910550	396
821812	97	828000	91	870018	86	902624	405	906424	405	910650	396
821824	94	828110	97	870024	85	902626	405	906514	403	910815	396
821928	97	828340	109	870033	86	902712	402	907108	398	911006	396
821932	97	828400	92	870039	85	902812	402	907214	398	911008	396
822028	109	828637	109	870040	86	902910	402	907300	399	911010	396
822033	109	828800	97	870041	86	903000	402	907407	398	911422	403
822037	109	828914	112	870042	86	903005	401	907408	398	911514	396
822040	109	828918	112	870043	86	903007	401	907512	397	911522	396
822141	94	835012	87	870424	241	903008	401	907514	397	911806	404
822236	109	835125	87	870428	241	903132	405	907634	400	911809	404
822239	109	835130	87	870500	383	903210	406	907700	399	911850	404
822310	97	835231	87	870550	383	903308	409	907800	399	911910	404
822530	95	835235	87	870600	382	903311	404	907932	399	912214	396
822630	95	835320	87	870650	382	903314	404	908022	397	912214T	402
822823	94	835324	87	870660	382	903425	405	908024	397	912218	396
822912	97	835328	87	870820	85	903522	406	908028	397	912518	404
823036	93	835330	87	870926	85	903524	406	908032	397	912612	33
823200	91	835424	86	871300	184	903812	402	908118	397	912614	33
823410	96	835539	87	871406	180	903814	402	908120	397	912616	33
823528	93	840026	77	871600	124	903925	401	908122	397	912922	401
823624	94	840126	78	871800	124	903930	401	908124	397	912924	401

Ref.	Pag.	Ref.	Pag.	Ref.	Pag.
912928	401	930220	33	942005	391
912932	401	930224	33	942006	391
912936	401	930228	33	942100	409
913010	399	930314	33	942101	409
914534	33	931624	61	942102	409
914538	33	931624T	61	942103	409
914542	33	935010	394	942104	409
914618B	34	935122	393	942105	409
914618M	34	935124	393	942200	407
914618N	34	935126	393	942201	407
914618P	34	935128	393	942202	407
914618T	34	935208	393	942203	407
914618V	34	935332	394	942204	407
914622N	34	935410	394	942205	407
915012	33	935508	409	961224T	61
915014	33	935511	394	970712	315
915016	33	935514	394	970714	315
915018	33	935625	394	970716	315
916318	65	935724	394	970718	315
916320	65	935812	393	970720	315
916322	65	935930	393	970722	315
916324	65	935935	393	970724	315
916326	65	936012	393	970726	315
916328	65	936114	393	970728	315
916526	65	936212	393	970730	315
916528	65	936214	393	970732	315
916530	65	936312	408	970736	315
916532	65	936422	394	970800	315
916728	65	936509	394	970805	315
916732	65	936610	394	970810	315
916736	65	936722	393	970815	315
916740	65	936724	393	970914	315
917130	73	936728	393	970916	315
917134	73	941600	408	970918	315
917138	73	941601	408	970920	315
918508	395	941602	408	970922	315
918632	395	941603	408	970924	315
918710	395	941604	408	970926	315
918807	395	941605	408	970928	315
919225	395	941606	408	970930	315
919322	395	941607	408	970932	315
919916	106	941650	408	971600	316
919918	106	941651	408	971612	315
919920	106	941652	408	971616	315
925008	400	941653	408	971618	315
925108	400	941654	408	971620	315
925210	400	941655	408	971622	315
925301	400	941656	408	971624	315
925414	400	941657	408	971626	315
925510	400	941658	408	971628	315
930014A	64	941700	409	971630	315
930014B	64	941701	409	971632	315
930014C	64	941702	409	975500	406
930014D	64	941703	409	980032	67
930014E	64	941704	409	CC02	134
930014F	64	942000	391	CCA01	134
930116	33	942001	392	CG02	134
930120	33	942002	392	CH01	134
930124	33	942003	392	CNW0102	134
930216	33	942004	391	CPA01	134





